



See the world in a different light



OEM MODULE GUIDE



About Dialight Corporation

Founded in 1938, Dialight Corporation is the worldwide leader in applied LED technology. With applications ranging from low power Panel Mount and Circuit Board Indicators, to high power Traffic, Obstruction, Beacon, Vehicle, and Rail, our experience with LED is unparalleled. With expertise in optical, thermal, mechanical and electrical design, as well as ISO 9001 certified manufacturing, Dialight has the technical & practical expertise to turn the dream of solid state lighting into reality.

*Front cover photos:
A selection of products
from our wide range
including power drivers,
single and full color
lighting arrays and optics.*



OEM Module Guide

Issue 4.2008

This guide is intended to give an overview of Dialight Lumidrives standard product offerings as of April 2008. If you have a requirement which is not covered by the standard products within this guide, please do not hesitate to contact us, as a large part of our business is built around getting companies to market with our innovative custom designed solutions.

Please contact us at info@dialight.com, or call us at 1-732-919-3119 to discuss your particular requirements and see how Dialight can best meet your needs.



Symbols and Definitions

Boxed Symbol

Explanation of the symbol



The minimum and maximum number of LEDs per channel that can be run at 350mA



The minimum and maximum number of LEDs per channel that can be run at 700mA



The minimum and maximum number of LEDs per channel that can be run at 1000mA



Dimming (0-100%) is achieved via an on board DMX512 interface combined with PWM power control



The driver is designed for use with RGB LEDs which can be controlled via a remote control



The driver has a 1-10V dimming facility



Dimmable on Phase Cut Dimming



The LEDs can be dimmed via an external potentiometer



The Lifesaver™ is a unique thermal feedback circuit which constantly monitors LED temperature ensuring reliability and protection



Input voltage range measured in V AC



Input voltage range measured in V DC



The operating ambient temperature measured in degrees Celcius



The max. permitted case temperature of the driver measured in degrees Celcius



Photo courtesy of Lux Lumen - Arch Esther Gutner for Mer du Nord

Useful Information

In January 2006 Lumidrive was acquired by Dialight PLC the world leader in applied LED technology. Moving forward the combined strengths of Dialight-Lumidrive means we are well positioned to drive the advancement of solid state lighting on a global basis, through product innovation, manufacturing excellence and dedicated customer support at a local level.

Dialight Lumidrive is a vertically integrated supplier providing system level modules in all technology areas required to create reliable LED lighting solutions.

Dialight Lumidrive has been providing leading edge technology for illumination applications since 2001. Our technology is working reliably in millions of applications worldwide.





Photo courtesy of Lux Lumen - Fabric Design

Technology Trends

Dialight Lumidrive is committed to supplying customers with the best possible LED technology and associated value adding products. This technology driving our business is moving fast with month by month improvements in efficiency and power density. In this catalog, we only present products which are available to ship now, but in our development program we have many new products and concepts. To keep fully up to date with what innovation we can offer please visit our web site www.dialight.com and select "Solid State Lighting".

Dialight Lumidrive uses LEDs only from quality LED manufacturers who provide accurate data and reliability criteria. We select the LED on the basis of performance in a particular application e.g. flux, color performance, uniformity, thermal characteristics and cost. The type of LED used in a product may change to reflect the best total performance offered in the LED market.

Product Labeling and Binning

When LEDs are manufactured they are grouped or "binned" according to luminous flux, color (nm or CCT) and voltage. This means that when viewing LEDs from multiple bins, different colors or shades may be noticeable. This affects LEDs from all manufacturers and the industry is continuously researching and improving production methods to reduce variability.

During our normal production we select LEDs to minimize the effects of binning for our customers. Products produced by Lumidrive are uniquely labeled to identify the type and bin of LED used, should a replacement be required in the future.

The human eye is very susceptible to variations in white light, we recommend new users of white LEDs and users with large projects to contact us to discuss the details of the application. Dialight Lumidrive has extensive application expertise in projects with 100,000s of individual LEDs and has successfully managed LED selection in very demanding applications.

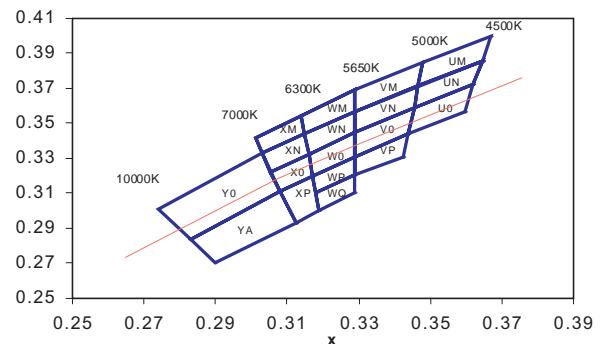

Photometrics

Dialight Lumidrives offers full photometric performance data for all standard light engines. Copies of this data are available upon request together with IES files for integration within lighting design programs.

Part:	blue	no lens	15 deg	Date:	21/3/06 By:rh
VAC:		mA		Distance:	26.8 718.24

Chromaticity		Dom wav	Peak wav	CCT	Flux
x	y	(nm)	(nm)	(K)	lm
0.1471	0.0326	459.5	455.6	0	100.9

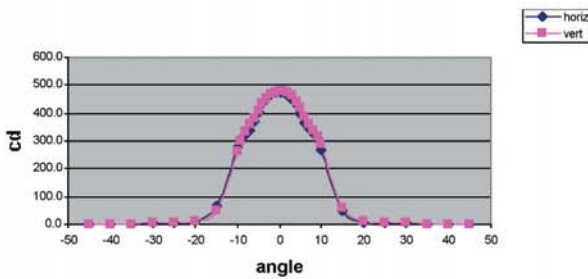

Data quoted for light output in our data sheets is based upon typical operating temperatures and conditions rather than manufacturer's junction temperature test conditions.

Blue			
V Angle	cd	H Angle	cd
45	1.9	45	1.6
40	2.0	40	1.7
35	2.5	35	2.2
30	3.2	30	2.8
25	4.7	25	4.3
20	9.7	20	8.0
15	62.5	15	51.4
10	286.9	10	267.9
9	317.6	9	307.5
8	340.4	8	327.6
7	357.7	7	345.0
6	387.1	6	365.4
5	420.5	5	398.0
4	439.1	4	430.0
3	461.3	3	447.1
2	472.0	2	466.4
1	480.1	1	473.8
0	478.5	0	476.9
-1	475.4	-1	476.6
-2	467.8	-2	470.6
-3	452.6	-3	455.4
-4	437.5	-4	436.2
-5	407.9	-5	402.4
-6	384.3	-6	369.2
-7	361.1	-7	339.8
-8	331.6	-8	320.1
-9	298.0	-9	303.4
-10	263.9	-10	276.6
-15	48.3	-15	64.2
-20	9.0	-20	10.4
-25	4.6	-25	4.7
-30	2.8	-30	2.8
-35	2.2	-35	2.1
-40	2.0	-40	1.7
-45	1.8	-45	1.6

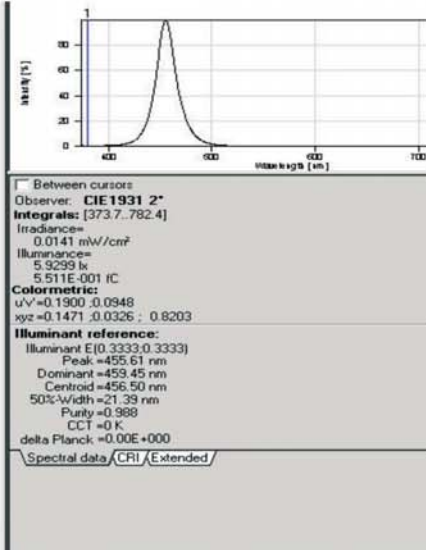
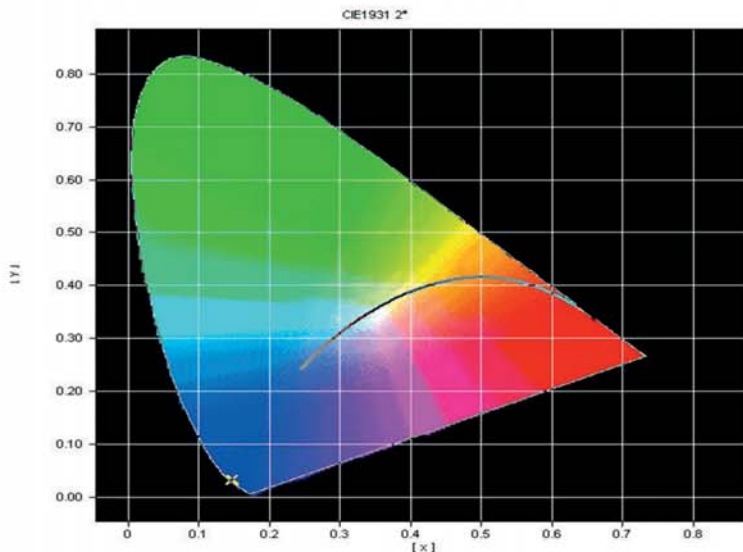

Thermal Management

Thermal management of LED products is critical to short term performance and longer term reliability. Generally most LED light engines contained in the catalog require additional heat sink components; the heat sink ultimately is the lighting fixture in which they are fitted.

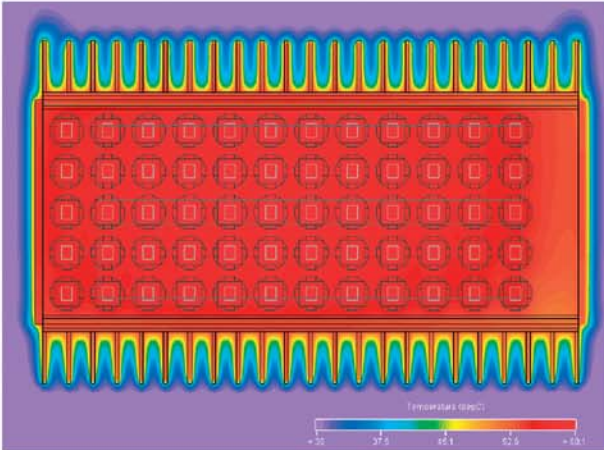

Dialight Lumidrive has experience in both retrofitting components to existing fixture designs, where possible, and advising customers on the optimum way to design new fixtures.

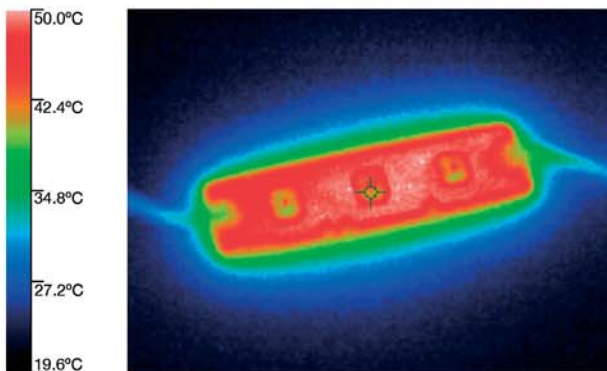

CAD Thermal Analysis of design prior to manufacture

Thermal analysis of assembled Light Engine

We select thermal management materials to achieve the best performance in the final application and combine this with our unique lifesaver thermal protection and feedback.

Design and Integration

Dialight Lumidrive can support customers from the specification of an individual optic, driver or light engine through to integration of components into existing product lines or the design of new ranges to maximize the benefits of LED technology.

Where our range of standard solutions do not match the product requirements, we can offer custom designed solutions or derivatives in optics, drivers, light engines, or heat-sinks.

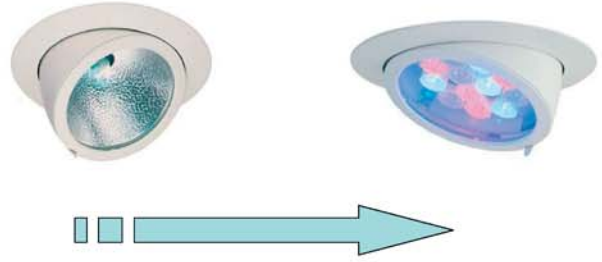

New Designs



Exterior fixture using Lumidrive Color engine 36

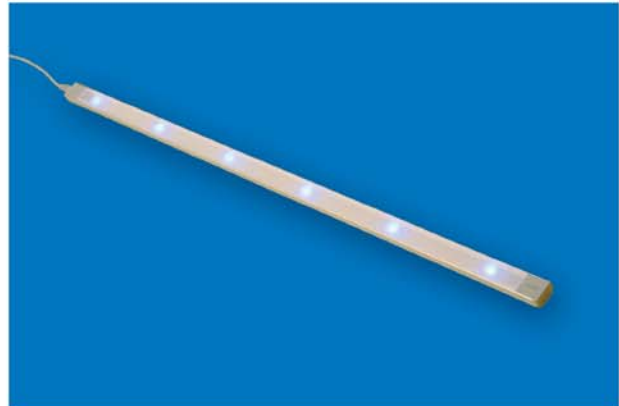

Custom linear lighting solution



Colordriver® XP

The Colordriver XP is an IP67 rated, four-channel RGBA/RGBW led driver capable of driving up to 48 LEDs with total output power of up to 132W.

With 4 independent channels for wider color gamuts, the colordriver XP supports today's high power LED color mixing applications. Max output current per channel can be independently set at 350, 500, 700 or 1000ma allowing you to drive InGaN leds harder than AlInGaP. The Colordriver XP is DMX addressable and also comes with 38 pre-programmed shows. The unit accepts input voltage from 90-264VAC 50/60Hz and is rated for dry, damp & wet environments.

Order codes: CDU-XP-DMX-CON-IP

Dimensions: L297mm x W198mm x H82mm

Weight: 2.45kg

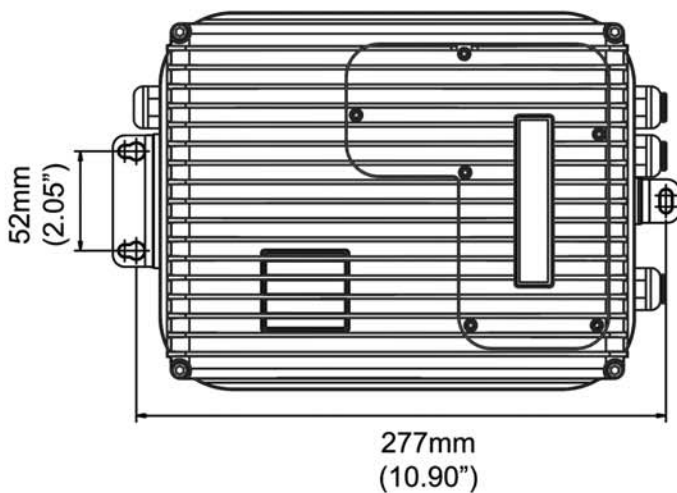



Colordriver™ RFCC

Connection Conditions

1W LEDs per Master Unit	18
1W LEDs per Slave Unit	18
No. of Slaves per Master Unit	100
Max. Cable Length to LEDs	10m
Max. Cable Length between Drive Units	30m
Total Circuit Cable Length	1km

Colordriver RF Remote Control Specification

Battery Voltage/Type	AAA alkaline cell
Battery Life	>30,000 keypresses
RF Frequency	433.92MHz
Modulation	FM
Dimensions	L96.0mm x W47.0mm x H24.0mm

Operating Modes

- Color Cycle
- Fixed Color
- On/Off
- Two selectable memories

The Colordriver™ RFCC is a three-channel RGB LED driver, which combines an intelligent power driver with an intuitive RF remote control. Both masters & slaves can drive up to 18 total 1W LEDs (3 channels X6). Up to 99 slaves can be added per master thus allowing control of up to 1800 LEDs with a single remote.

All Dialight Lumidriives Colordrivers come with the "Lifesaver™" system which (when used with "Lifesaver"™ equipped Dialight-Lumidriives Colorengines) monitors PCB temperature and automatically throttles back the drive current should the system overheat to ensure long LED lifetime.

Wall Mounted Control Unit

The control unit plugs directly into a slave module giving the same functions as a wireless remote. Additionally it can accept an input from a DMX control system. In this mode the front plate is disabled.

Order codes:

RFCC Master:	CDURF-3-35
RFCC Slave:	CDUSL-3-35
RFCC Remote:	CDURF-TX
SL Control:	CDUSL-CU

Dimensions:

L179mm x W53mm x H32mm

Weight:

163g

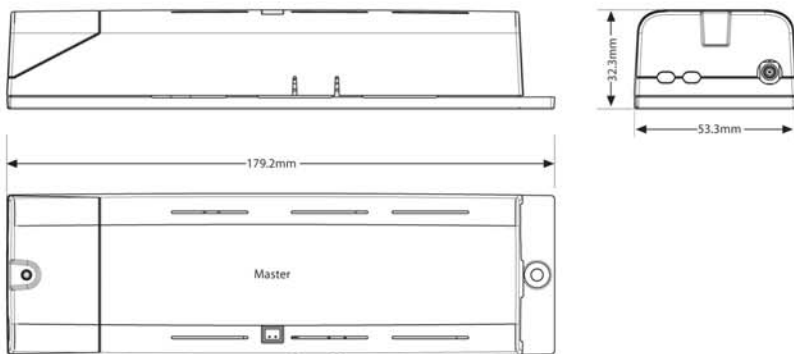

CDU-L-3-35-DMX

Colordriver™ 36

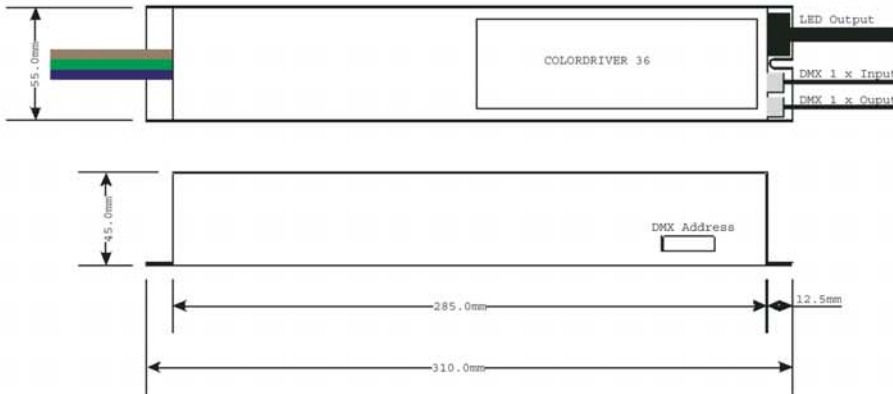

The Colordriver™ 36 is a DMX controlled three-channel RGB LED driver, capable of driving up to a maximum of 36 LEDs.

All Dialight Lumidrive Colordrivers come with the "Lifesaver™" system which (when used with "Lifesaver™" equipped Dialight-Lumidrive Colorengines) monitors PCB temperature and automatically throttles back the drive current should the system overheat to ensure long LED lifetime.

All connections to the driver are plug and socket for rapid installation.

Order codes: CDU-L-3-35-DMX

Dimensions: L310mm x W55mm x H45mm

Weight: 1020g





PowerWhite Driver

The PowerWhite Driver is designed to run up to 45 LEDs at 350ma or 24 LEDs at 700ma from a 90-264Vac power supply. With up to 60W output power, built in thermal protection, no electrolytic capacitors, die-cast construction and IP67 rating, it is ideal for use in applications requiring high reliability, long life & rugged construction.

Order codes: PWD60-35-70

Dimensions: L191mm x W538mm x H33mm

Weight: 670g



MDU4-SC-35



Microdriver 4

The Microdriver 4 is designed to drive up to 4 x 1W high powered LEDs at 350mA from a 110 - 240V AC power supply.

Order codes: MDU4-SC-35

Dimensions: L99mm x W39mm x H23.5mm

Weight: 70g

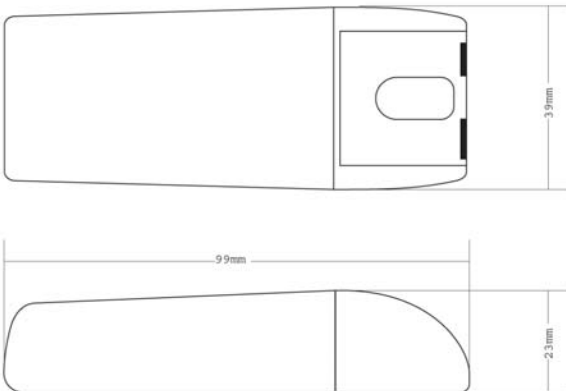

MDU9-SC-35/70



Microdriver 9

The MDU9-SC-35/70 is designed for driving 9 x 1W LEDs at 350mA or 4 x 3W LEDs at 700mA from a 110 - 240V AC supply.

Order codes: MDU9-SC-3570

Dimensions: L99mm x W39mm x H23mm

Weight: 70g

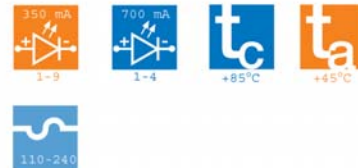
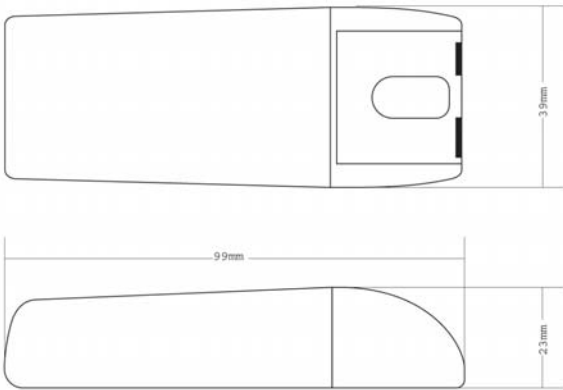



Microdriver LV9 & LV3

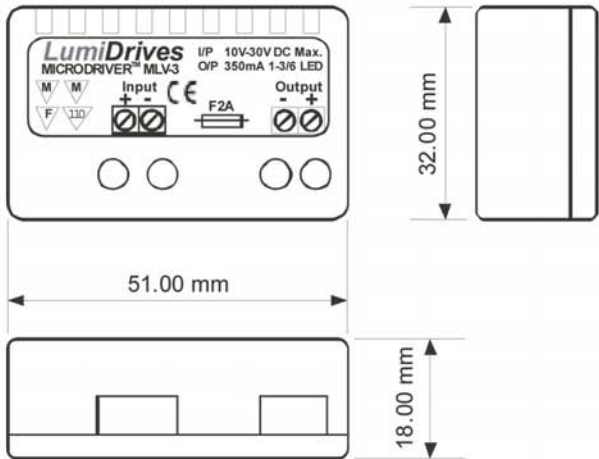

The Microdriver LV9 is a fully potted & dimmable unit ideal for driving high power LEDs from a range of low voltage power supplies between 12 to 24 volts. It will drive up to 9 x 1W LEDs at 350mA or 4 x 3W LEDs at 700mA.

For full output, the dimming link must be cut.

Order codes: MLV9-C-35
MLV9-C-70

Dimensions: L70.5mm x W49mm x H11.2mm

Weight: 65g

The Microdriver LV3 is ideal for driving high power LEDs from a range of low voltage power supplies between 10 to 30 VDC. It will drive up to 3 x 1W LEDs at 350mA or 4 x 1W at 700mA.

Order codes: MLV3-C-35
MLV3-C-70

Dimensions: L51mm x W32mm x H11.2mm

Weight: 18g



Power RGB Modules

COMING SOON

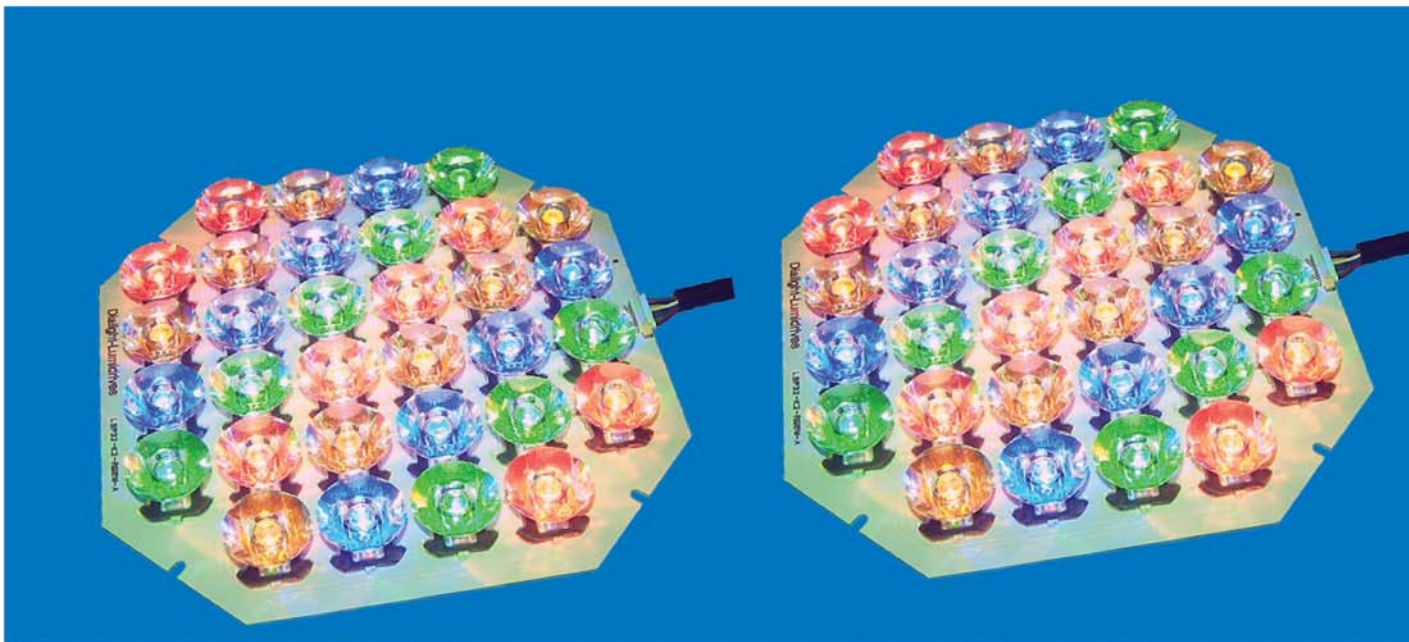

K2 Lumispot Light Engines

Code 1	# of LEDs	Code 2	Color	
LSP	12	K2	RGBA	Red / Green / Royal Blue / Amber
	32		RGBW	Red / Green / Royal Blue / Cool White
			WWWW	All 4 channels Cool White

LED output data in Lumens or mW			
Color	@ 350mA	@ 700mA	@ 1000mA
Red	361m	601m	n/a
Green	361m	601m	801m
Royal Blue	176mW	294mW	380mW
Amber	361m	601m	n/a
Cool White	361m	601m	801m

LSP12 - K2 - RGBA (example only)
 Create your own order code by using the above table.

The Lumispot K2 light engines are clusters of 12 or 32 Luxeon® K2 LEDs in either RGBA, RGBW, or WWWW colors. Ideal for creating powerful beams of white or color changing light with wide gamuts, they come complete with thermal protection, input cables & 3 degree spot optics. Secondary optics can also be added to create wide, diffuse, or oval optical patterns.

Lumispot K2 12-up

Dimensions: L127mm x W100mm x H15.5mm

Lumispot K2 32-up

Dimensions: L180mm x W180mm x H15.5mm

Recommended sub-lenses:

OPAA-1-DF 6 degree diffused sub-lens
 OPAA-1-WSL 12 degree wide sub-lens
 OPAA-1-OSL 4x27 degree oval sub-lens

All angles are half divergence

Recommended driver:

CDU-XP-DMX-CON-IP Colordriver XP



(Except Red or Amber)



Color Engines

Code		Color		Optics		Lumens/mW
CE	3C	R	Red	005	5°	105
		G	Green	015	15°	126
		B	Blue	025	25°	528 mW
		520	5° x 20°			
		xxx	none			
CE	6C	R	Red	005	5°	210
		G	Green	015	15°	252
		B	Blue	025	25°	1056 mW
		520	5° x 20°			
		xxx	none			
CE	12C	R	Red	005	5°	420
		G	Green	015	15°	504
		B	Blue	025	25°	2112 mW
		520	5° x 20°			
		xxx	none			
CE	18C	R	Red	005	5°	630
		G	Green	015	15°	756
		B	Blue	025	25°	3168 mW
		520	5° x 20°			
		xxx	none			
CE	36C	R	Red	005	5°	1260
		G	Green	015	15°	1512
		B	Blue	025	25°	6336 mW
		520	5° x 20°			
		xxx	none			
CE	12L	R	Red	005	5°	420
		G	Green	015	15°	504
		B	Blue	025	25°	2112 mW
		520	5° x 20°			
		xxx	none			
CE	18L	R	Red	005	5°	630
		G	Green	015	15°	756
		B	Blue	025	25°	3168 mW
		520	5° x 20°			
		xxx	none			



The Color Engine is an integrated Red, Green and Blue light engine, which enables the creation of dynamic color changing applications using LED technology. It is available in a choice of five circular and two linear modules and is complete with optics and optic holders. There are also four different beam angle options for the optics.

Noted models come with the "Lifesaver™" system which (when used with any Dialight-Lumidrive Colordriver) monitors PCB temperature and automatically throttles back the drive current should the system overheat to ensure long LED lifetime.

Color Engine 3C

A circular Color Engine complete with 1 each of Red, Green & Blue LUXEON® I LEDs.

Dimensions: L48mm diameter
H15.5mm

Color Engine 6C

A circular Color Engine complete with 2 each of Red, Green & Blue LUXEON® I LEDs.

Dimensions: L69mm diameter
H15.5mm

Color Engine 12C

A circular Color Engine complete with 4 each of Red, Green & Blue LUXEON® I LEDs.

Dimensions: L90mm diameter
H15.5mm

Color Engine 18C

A circular Color Engine complete with 6 each of Red, Green & Blue LUXEON® I LEDs.

Dimensions: L110mm diameter
H15.5mm

Color Engine 36C

A circular Color Engine complete with 12 each of Red, Green & Blue LUXEON® I LEDs.

Dimensions: L120mm diameter
H15.5mm

CE3C - RGB - XXX (example only)

Create your own order code by using the above table.

Note- All Color Engine models are typically sold as "XXX" versions with optic holder but no optic. F-form 005, 015, 025 or 520 optics can be purchased and installed separately.



Color Engines cont.

Color Engine 12L

A linear Color Engine complete with 4 each of Red, Green & Blue LUXEON® I LEDs & CT4 Quick Connects for easy wiring & installation.

Dimensions: L290mm x W35mm x H15.5mm

Color Engine 18L

A linear Color Engine complete with 6 each of Red, Green & Blue LUXEON® I LEDs & CT4 Quick Connects for easy wiring & installation.

Dimensions: L590mm x W22.5mm x H15.5mm

Note- All Color Engine models are typically sold as “XXX” versions with optic holder but no optic. F-form 005, 015, 025 or 520 optics can be purchased and installed separately.





Powerwhite Modules

Code	Driver		LED Color		Optic	
LML6	C1	Requires constant current driver	CW	Cool White	SP	5 degree spot
					MD	15 degree medium
			WD	25 degree wide		
	LV	Onboard 350mA driver	NW	Neutral White	OV	5x20 degree oval
					FR	7 degree frosted spot
			WW	Warm White	<i>All angles are half divergence</i>	

LED data			
Color	min output @ 350mA	min output @ 700mA	Median color temp
Cool White	80 LM	145 LM	5300k ("V" bins)
Neutral White	70 LM	130 LM	3950k ("S" bins)
Warm White	60 LM	110 LM	2950k ("N" bins)

Powerwhite modules represent the latest best innovation in LED light engines. Incorporating the best readily available flux Luxeon® REBEL LEDs, Powerwhite modules are truly lighting grade. Built in primary heatsinking, optics, thermal protection and available on-board constant current drivers allow for a complete plug and play LED lighting solution.

LML6-C1 series

6 Rebel LEDs per module
Requires constant current driver

Recommended driver:

PWD60-35-70 Powerwhite Driver

Can be driven at 350mA or 700mA

LML6-LV series

6 Rebel LEDs per module
Comes with onboard 350mA constant current driver
Input voltage 8-17VDC / 12-24VAC
Power consumption 8.5W per module

Dimensions: L297mm x W38mm x H15mm
(both series)



LML6 - C1 - NW - SP (example only)
Create your own order code by using the above table.



Lumispot Light Engines

The Lumispot Light Engines are available in a range of circular LED arrays complete with optics and white optic holders. They come in a choice of six different single color LEDs and four different beam angles.

Code		Color		Optics		Lumens/mW
LSP	1	R	Red	005	5°	35
LSP	1	G	Green	015	15°	42
LSP	1	B	Blue	025	25°	176 mW
LSP	1	W	White	520	5° x 20°	36
LSP	1	A	Amber			34
LSP	1	WW	Warm White	xxx	none	16
LSP	3	R	Red	005	5°	105
LSP	3	G	Green	015	15°	126
LSP	3	B	Blue	025	25°	528 Mw
LSP	3	W	White	520	5° x 20°	108
LSP	3	A	Amber			102
LSP	3	WW	Warm White	xxx	none	48
LSP	6	R	Red	005	5°	210
LSP	6	G	Green	015	15°	252
LSP	6	B	Blue	025	25°	1056 mW
LSP	6	W	White	520	5° x 20°	216
LSP	6	A	Amber			204
LSP	6	WW	Warm White	xxx	none	96
LSP	1	R	Red	005	5°	315
LSP	1	G	Green	015	15°	378
LSP	1	B	Blue	025	25°	1584 mW
LSP	1	W	White	520	5° x 20°	324
LSP	1	A	Amber			306
LSP	1	WW	Warm White	xxx	none	144

LSP9 - R - XXX (example only)
Create your own order code by using the above table.

Lumispot 1

A single LUXEON® I LED with optic and optic holder on PCB, which has 4 notches cut out of the profile to allow for rear cable entry without encroaching on the circumference of the PCB.

Dimensions: L21.5mm diameter
H15.5mm

Lumispot 3

A group of 3 LUXEON® I LEDs with optics and optic holders.

Dimensions: L48mm diameter
H15.5mm

Lumispot 6

A group of 6 LUXEON® I LEDs with optics and optic holders.

Dimensions: L69mm diameter
H15.5mm
L23mm inner diameter

Lumispot 9

A group of 9 LUXEON® I LEDs with optics and optic holders.

Dimensions: L90mm diameter
H15.5mm



Note- All Lumispot light engines are typically sold as "XXX" versions with optic holder but no optic. F-form 005, 015, 025 or 520 optics can be purchased and installed separately.

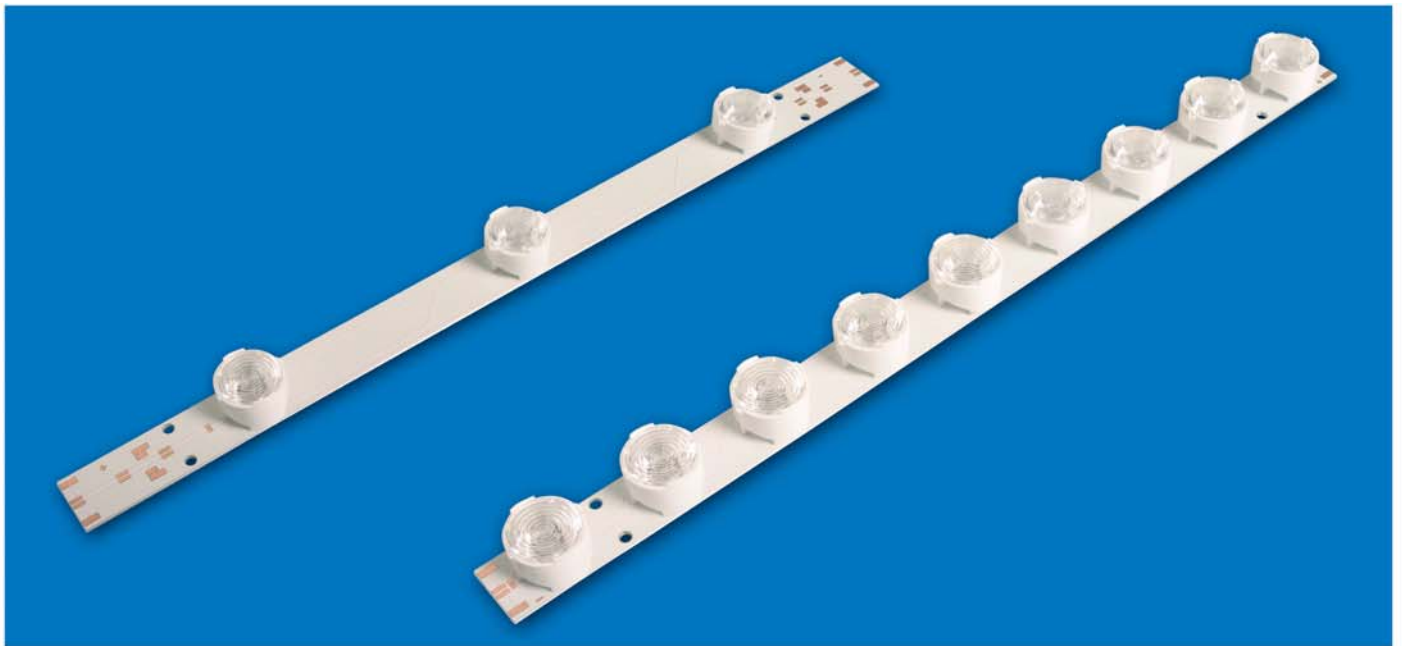

Lumiline Light Engines

Code	No. of LEDs	Color		Optics		Lumens/mW
LLN	3	R	Red	005	5°	105
LLN	3	G	Green	015	15°	126
LLN	3	B	Blue	025	25°	528 mW
LLN	3	W	White	520	5° x 20°	108
LLN	3	A	Amber			102
LLN	3	WW	Warm White	xxx	none	48
LLN	9	R	Red	005	5°	315
LLN	9	G	Green	015	15°	378
LLN	9	B	Blue	025	25°	1584 Mw
LLN	9	W	White	520	5° x 20°	324
LLN	9	A	Amber			306
LLN	9	WW	Warm White	xxx	none	144

LLN9 - R - XXX (example only)
 Create your own order code by using the above table.

Note- All Lumiline light engines are typically sold as "XXX" versions with optic holder but no optic. F-form 005, 015, 025 or 520 optics can be purchased and installed separately.

The Lumiline Light Engines are available in two linear module types complete with optics and white holders to match the white surface of the PCB. they come in a choice of six different single color LEDs and four different beam angles.

Modules with production dates of 5/2007 or later come with 12" lead wires.

Lumiline 3

A linear array of three LUXEON® I LEDs.

Dimensions: 324mm x 15.5mm

Lumiline 9

A linear array of nine LUXEON® I LEDs.

Dimensions: 324mm x 15.5mm





Lumilight Light Engines

Code	No. of LEDs	Color		Lumens/mW
LLT	3	R	Red	105
LLT	3	G	Green	126
LLT	3	B	Blue	528 mW
LLT	3	W	White	108
LLT	3	A	Amber	102
LLT	3	WW	Warm White	48
LLT	6	R	Red	210
LLT	6	G	Green	252
LLT	6	B	Blue	1056 Mw
LLT	6	W	White	216
LLT	6	A	Amber	204
LLT	6	WW	Warm White	96
LLT	9	R	Red	315
LLT	9	G	Green	378
LLT	9	B	Blue	1584 mW
LLT	9	W	White	324
LLT	9	A	Amber	306
LLT	9	WW	Warm White	144

LLT9 - R (example only)

Create your own order code by using the above table.

The Lumilight Light Engines are available in a range of three linear modules and come in a choice of six different single color LEDs. Each LED linear array will fit into a standard 15mm wide aluminium "U" channel and is designed to be attached to a heatsink structure with thermal adhesive or double-sided thermal tape. It offers a wide 120° viewing angle.

Modules with production dates of 5/2007 or later come with 12" lead wires.

[Lumilight 3](#)

A linear array with three LUXEON® I LEDs.

Dimensions: 324mm x 13.5mm

[Lumilight 6](#)

A linear array with six LUXEON® I LEDs.

Dimensions: 324mm x 13.5mm

[Lumilight 9](#)

A linear array with nine LUXEON® I LEDs.

Dimensions: 324mm x 13.5mm





LUXEON® K2 BASED HL16

**HL16K Single Color Selection Guide
with or without built in driver**

Code	Driver	Color		Lumens/mW @ 350mA
HL16K	D = Onboard Driver (blank) = Requires CC Driver	R	Red	105
		G	Green	126
		B	Blue	528 mW
		W	Cool White	210
		A	Amber	102
		WW	Warm White	150
		NW	Neutral White	180

HL16K - D - R (HL16 with driver in Red)
Create your own order code by using the above table.

HL16K - R (code without built in driver)

HL16K - RGB (color changing option)

A new and innovative range of compact lighting modules utilizing LUXEON® K2 LEDs designed to retrofit to existing MR16 based products. The HL16 Series incorporate a newly developed triple lens which is available in a choice of beam angles by means of an interchangeable sub-lens system. See page 24 for sub-lens changes.

HL16KD and HL16K

The HL16K can be used with our standard range of drivers. The HL16KD can be connected directly to a 12 - 24V AC/DC source.

The Dialight Lumidrives HL16D comes with the "Lifesaver™" system which monitors PCB temperature and automatically throttles back the drive current should the system overheat to ensure long LED lifetime.

Dimensions:

- Height: 35.5mm
- Diameter of body: 46.5mm
- Diameter of lens: 50mm

HL16K RGB

A compact light fitting equipped with RGB LEDs to provide a full color change facility.

Dimensions:

- Height: 35.5mm
- Diameter of body: 46.5mm
- Diameter of lens: 50mm





HL16

HL16 Single Color Selection Guide with or without built in driver

Code	Driver	Color		Lumens/mW
HL16	D = Onboard Driver (blank) = Requires CC Driver	R	Red	105
		G	Green	126
		B	Blue	528 mW
		W	Cool White	240
		A	Amber	102
		WW	Warm White	150

HL16 - D - R (HL16 with driver in Red)
Create your own order code by using the above table.

HL16 - R (code without built in driver)

HL16 - RGB (color changing option)

A new and innovative range of compact lighting modules utilizing the latest best available high flux LEDs designed to retrofit to existing MR16 based products. The HL16 Series incorporate a newly developed triple lens which is available in a choice of beam angles by means of an interchangeable sub-lens system. See page 24 for sub-lens changes.

HL16D and HL16

The HL16 can be used with our standard range of drivers. The HL16D can be connected directly to a 12 - 24V AC/DC source.

The Dialight Lumidrives HL16D comes with the "Lifesaver™" system which monitors PCB temperature and automatically throttles back the drive current should the system overheat to ensure long LED lifetime.

Dimensions:

Height: 35.5mm
Diameter of body: 46.5mm
Diameter of lens: 50mm

HL16 RGB

A compact light fitting equipped with RGB LEDs to provide a full color change facility.

Dimensions:

Height: 35.5mm
Diameter of body: 46.5mm
Diameter of lens: 50mm





LUXEON® K2 BASED HL11

HL11K Single Color Selection Guide

Code	Color		Lumens/mW
HL11K	R	Red	35
HL11K	G	Green	75
HL11K	B	Blue	330 mW
HL11K	W	White	75

HL11K - R (example only)

Create your own order code by using the above table.

A new and innovative range of compact lighting modules utilizing LUXEON® K2 LEDs designed to retrofit to existing MR11 based products.

The HL11K's incorporate a newly developed spot base module lens, which is available in a choice of beam angles by means of an interchangeable sub-lens system. See page 24 for sub-lens details.



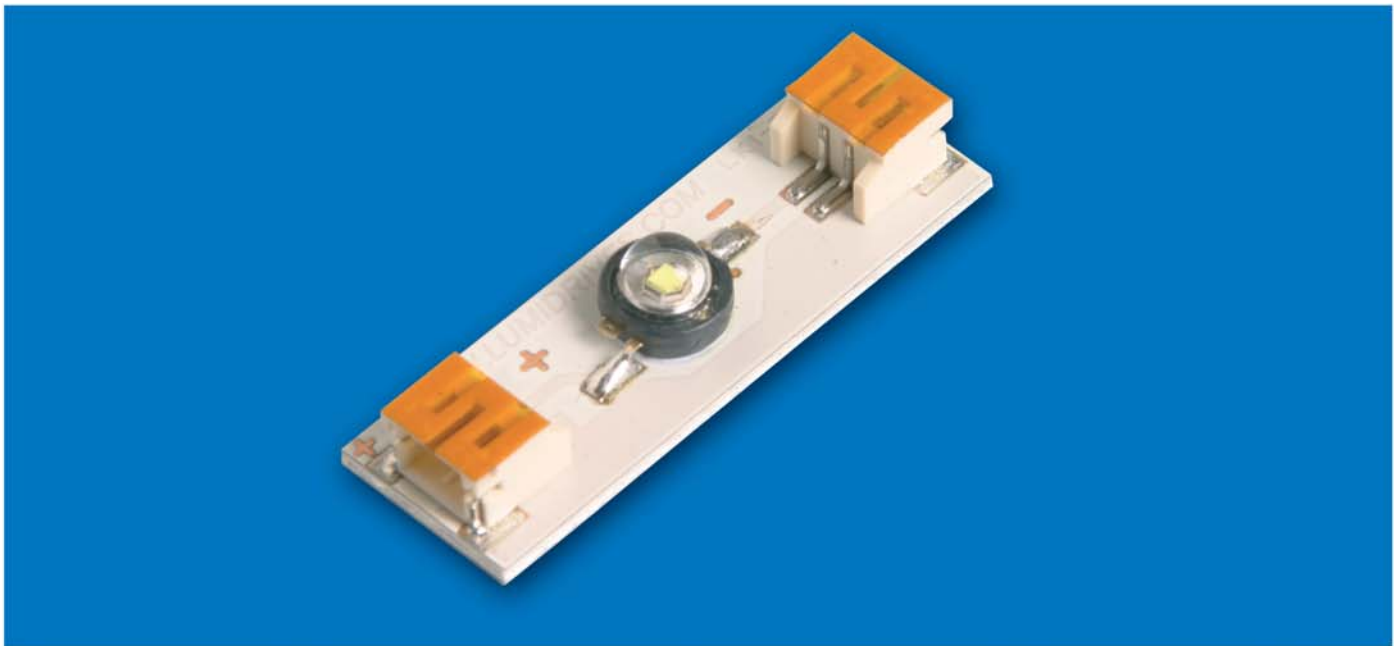

Single Color LinkLEDs

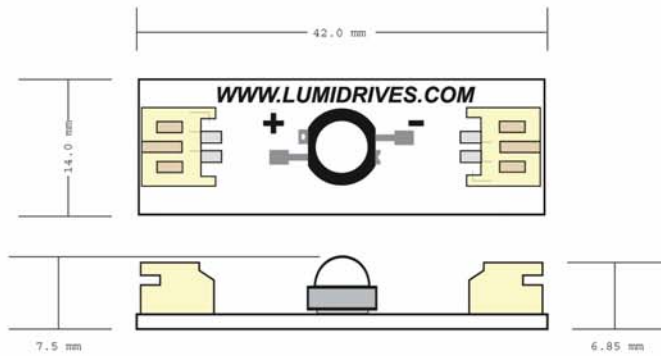

The LinkLED™ modules form the basis of an interlinking single color system of LUXEON® I LEDs which is compact and easy to install. The LinkLED is equipped with a thermal adhesive backed PCB for direct assembly to metal surfaces and pre-assembled CT2 series connecting blocks. It offers a wide beam angle of 120°. Use CT2 "Quick Connect" cables to group LinkLEDs together in any shape or size you need.

Dimensions:

L42mm x W14mm x
H6.85mm



Code		Color		Lumens/mW
LK1	1	R	Red	35
LK1	1	G	Green	42
LK1	1	B	Blue	176 mW
LK1	1	W	White	36
LK1	1	A	Amber	34
LK1	1	WW	Warm White	16

LK1 - 1 - R (example only)

Create your own order code by using the above table.



K2 LinkLEDs

Part Number	Color	Optic	Dimensions (mm) (L x W x H)
LK2-RGB	Red / Green / Royal Blue	n/a	54 x 28 x 7.5
LK4-RGBA	Red / Green / Royal Blue / Amber	n/a	70 x 30 x 7.5
LK4-RGBW	Red / Green / Royal Blue / Cool White	n/a	70 x 30 x 7.5
LKK2-OP-RGB	Red / Green / Royal Blue	3 degree spot optics	94 x 28 x 15.5
LKK2-OP-RGBA	Red / Green / Royal Blue / Amber	3 degree spot optics	121 x 30 x 15.5
LKK2-OP-RGBW	Red / Green / Royal Blue / Cool White	3 degree spot optics	121 x 30 x 15.5

LED output data in Lumens or mW			
Color	@ 350mA	@ 700mA	@ 1000mA
Red	361m	601m	n/a
Green	361m	601m	801m
Royal Blue	176mW	294mW	380mW
Amber	361m	601m	n/a
Cool White	361m	601m	801m

The Linkled K2 system of RGB, RGBA or RGBW LEDs are ideal for creating flexible sizes & shapes of color changing light. Available with or without 3 degree spot optics, all Linkled K2 are easily assembled with CT8 "quick connect" cables. Equipped with LUX-EON® K2 LEDs, Linkled K2 can be driven hard to achieve exceptional effects. Secondary optics can also be added to models with optics to create wide, diffuse, or oval optical patterns.

Recommended sub-lenses:

OPAA-1-DF 6 degree diffused sub-lens
 OPAA-1-WSL 12 degree wide sub-lens
 OPAA-1-OSL 4x27 degree oval sub-lens

All angles are half divergence

Recommended driver:

CDU-XP-DMX-CON-IP Colordriver XP



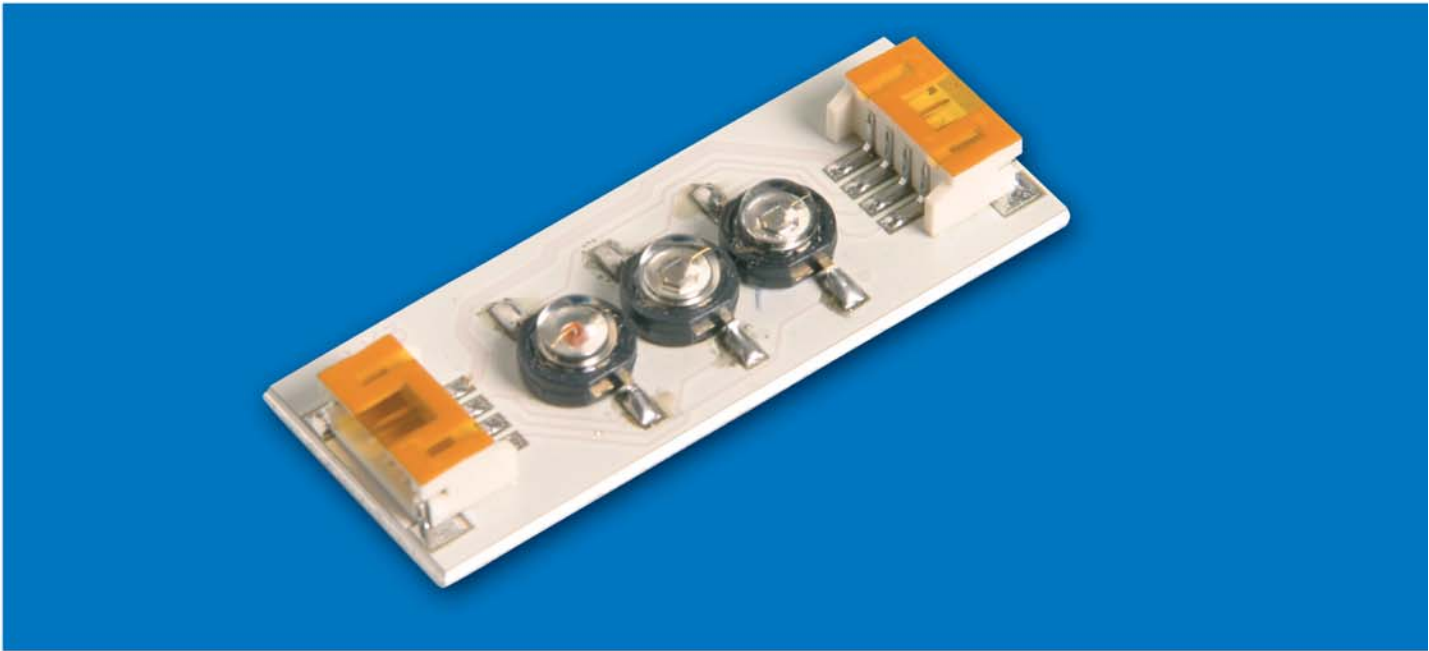

RGB LinkLEDs

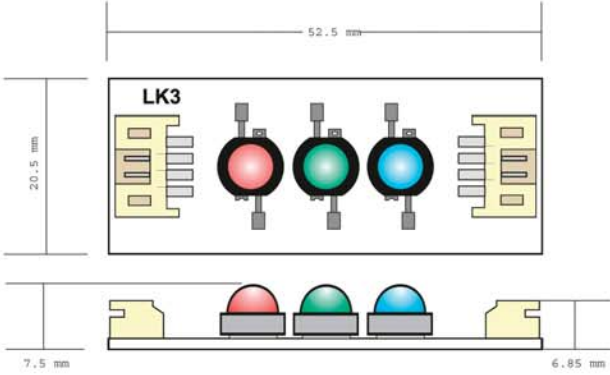

The RGB LinkLED™ high powered LED forms the basis of an interlinking Red, Green, Blue color system which is compact and easy to install. The LinkLED is equipped with a thermal adhesive backed PCB for direct assembly to metal surfaces and pre-assembled CT4 series connecting blocks. It offers a wide beam angle of 120°. Use CT4 “Quick Connect” cables to group LinkLEDs together in any shape or size you need.

Order code: LK-3-RGB

Dimensions: L52.5mm x W21mm x H7.85mm

LinkLED RGB is also available with optics. (Not pictured)

Order code: LKOP-RGB-XXX



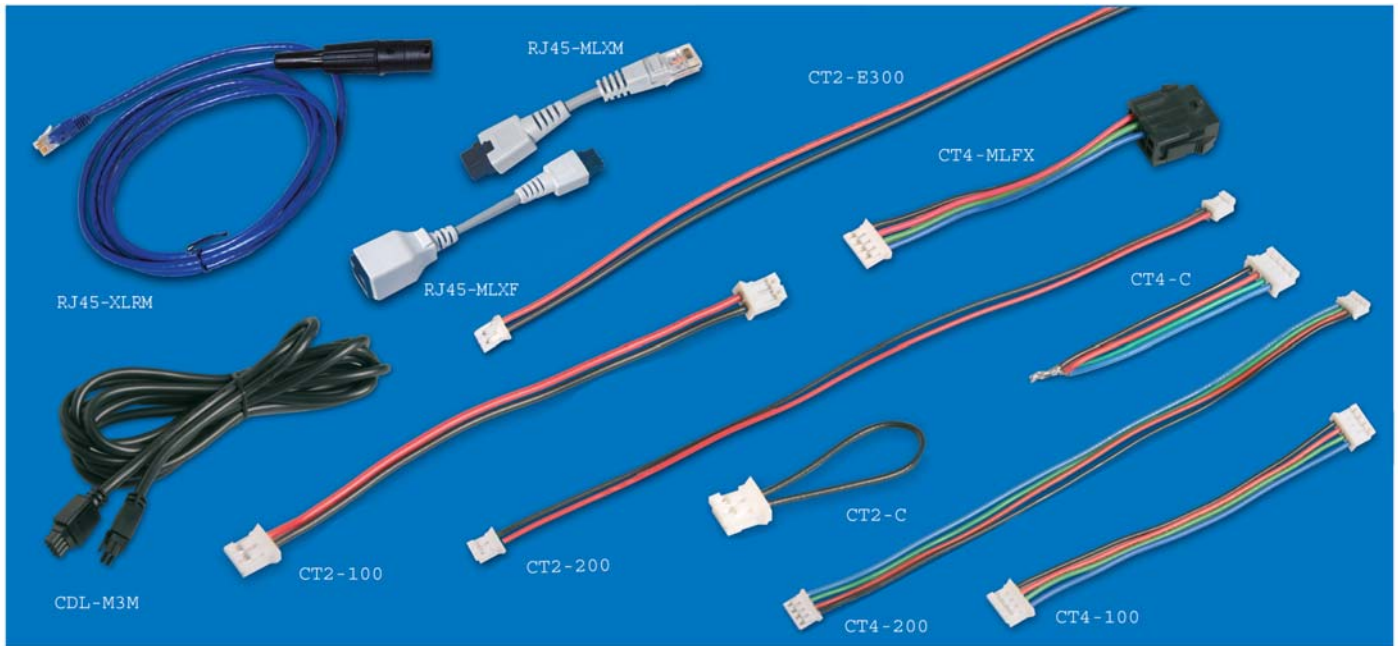

Linking Cables & Blocks

RJ45 Cables & Blocks

RJ45 cables are used to transmit control signals between RFCC master & slave ColorDrivers and also to drive HL16RGB modules. Cables are available to convert the molex output from the ColorDriver to an RJ45 format, from the RJ45 format to the HL16RGB input, & from a DMX signal to RJ45.

CDL-M3M	3 meter Molex male to male
RJ45-XLRF	Female DMX to RJ45 converter
RJ45-XLRM	Male DMX to RJ45 converter
RJ45-MLXF	Male Molex to RJ45 female
RJ45-MLXM	Male Molex to RJ45 male
RJ45-CON-ASSY	RJ45 to HL16RGB connector block
RJ45-C	Termination plug for last RJ45-CONN-ASSY block
RJ45-05	RJ45 to RJ45 cable, 0.5 meters
RJ45-2	RJ45 to RJ45 cable, 2.0 meters
RJ45-5	RJ45 to RJ45 cable, 5.0 meters

Powerwhite Linking Cables

LML6-CON-CAB	Entry cable, driver to 1st module
LML6-TER-CAB	End plug (required)
LML6-LV-CON-CAB	Entry cable, driver to 1st module (For LV modules)
LML6-LV-M2M-CAB	Connection cable (module to module) (For LV modules)

Molex Cables & Splitters

Molex cables are used to connect from the Dialight Lumidrive ColorDrivers to the various RGB Color engines & RGB Linkleds. A range of splitter blocks is available for driving multiple Color Engines from a single Color Driver.

CDL-M3M	3 meter Molex male to male
CDL-M3E	3 meter Molex male to wires for circular ColorEngines
CDJB3	3 way Molex splitter (female receptacles in & out)
CDJB7	7 way Molex splitter (female receptacles in & out)
CDJB-BL	End plug for Molex splitters

CT2 Linking Cables

The CT2 linking cables are the interlink connection cables for the LumiDrives LinkLED™ range of LED lighting products & any other light engines equipped with CT2 "Quick Connects". These cables are pre-connected with a 2 way plug to match the socket used on the LinkLED™. The range includes both interconnecting cables and end connector.

CT2-E300	2-way input lead
CT2-100	2-way link lead 100 mm
CT2-200	2-way link lead 200 mm
CT2-1000	2-way link lead 1000 mm
CT2-C	2-way common connector

CT4 Linking Cables

The CT4 linking cables are the interlink connection cables for the LumiDrives RGB LinkLED™ Linear ColorEngine ranges of LED lighting products. These cables are pre-connected with the 4 way plug to match the socket used on the LinkLED™. The range includes both interconnecting cables and end connector.

CT4-MLFM	4-way connection to Molex Male
CT4-MLFX	4-way connection to Molex Female
CT4-100	4-way link lead 100 mm
CT4-200	4-way link lead 200 mm
CT4-C	4-way common connector
CDL-M3M	8-way Molex – male to male

CT8 Linking Cables

CT8-1.25-100	8-way link lead 100mm
CT8-1.25-200	8-way link lead 200mm
CT8-CK	8-way end connector
CT8-1.25-3E	8-way link lead to wire ends (3m)

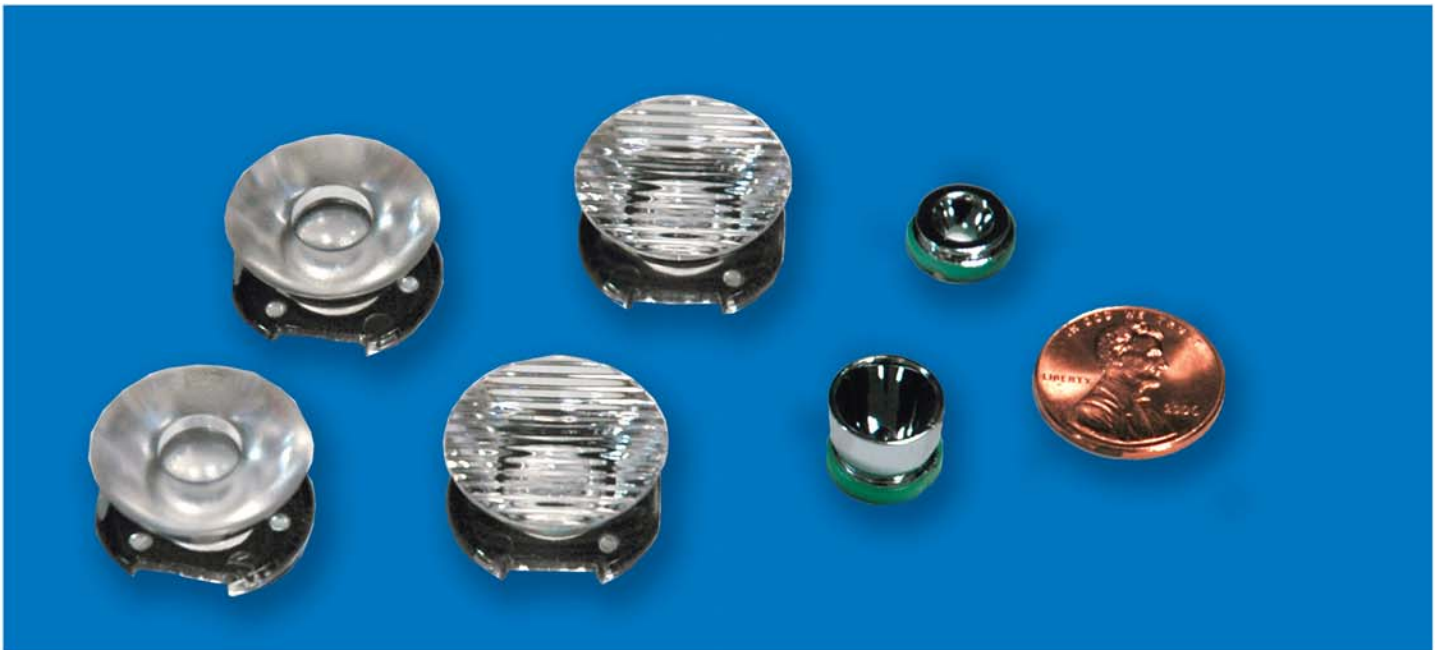

LUXEON® REBEL Optics

LUXEON REBEL OPTICS RANGE

Dialight Lumidrives have created a line of optics designed to harness the power of the smallest available high power LED on the market, the LUXEON Rebel. Available as either 21mm TIR optics, or our incredibly small 11mm collimators, all rebel optics are designed for ease of use with auto-alignment features to ensure correct focal points and adhesive backing for easy installation.

TIR Optics Part Numbers

OPC1-1-SPOT	Spot Optic	6°
OPC1-1-MED	Medium Optic	15°
OPC1-1-WIDE	Wide Optic	25°
OPC1-1-OVAL	Oval Optic	8° x 25°
OPC1-1-SDIF	Frosted Spot Optic	7°

Half divergence angles

11mm Collimating reflectors Part Numbers

OPC1-1-COL-SP	Spot Optic	7°
OPC1-1-COL-WD	Wide Optic	13°

Half divergence angles



L₂ Optics Range

Contents

24	L2 Optics Introduction
25-26	Adhesived Backed & Triples
26	F-Form
27	Special Lenses

Dialight Lumidrives offers a comprehensive range of lenses which have been tailored to suit various LEDs and common lighting applications used across the globe. All the L₂Optics lenses are made from optical grade PMMA (acrylics) to ensure excellent optical properties, as well as long-term material stability and durability. Two distinctive lens ranges have been developed: the F-Form and OPT series.

F-Form

The F-Form range consists of 20mm lenses and holders that have been specifically designed for use with:

- LUXEON I STAR, III STAR, V STAR & LUXEON® K2
- Osram Golden & Platinum Dragon

The holders position themselves easily and accurately on top of the LED and can be simply fastened onto the PCB by using an appropriate adhesive.

OPT Range (pictured above)

The OPT range consists of a unique adhesive backed spot base module with a selection of sub-lenses providing different beam angles. The series is available not only in a single but also a triple lens module complete with a choice of two sub-lenses. The optics are tailor-made for specific use with the following LED families:

- CREE XLamp®
- LUXEON® K2
- Nichia
- Osram Golden Dragon

L₂ Optics OPT Series 1

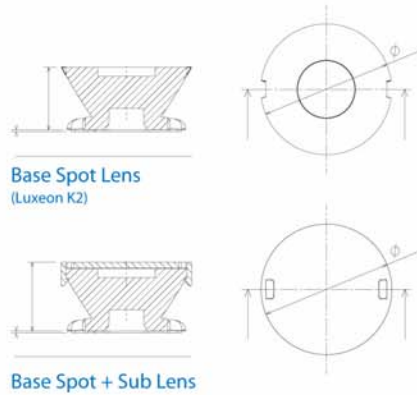
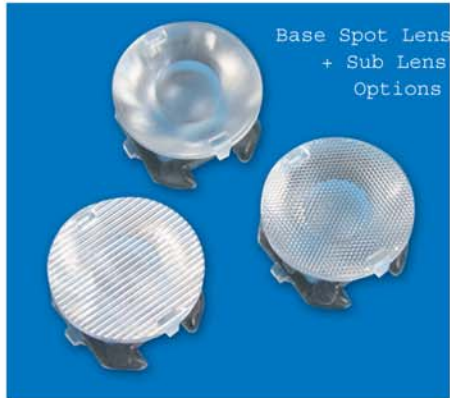

L₂Optics adhesive backed OPT Series 1 base lenses position easily and accurately over the LED. They are easy to fix onto the PCB using the integral self-adhesive pad.

The snap-lock-sub-lenses attach easily, are very secure and do not move or drop-out, once in place.

There are three different sub-lens illumination patterns available: spot, wide and oval.

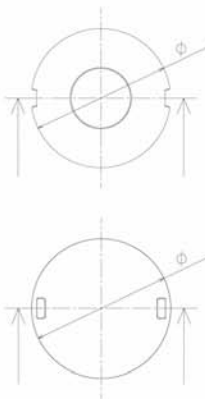

Base Lenses

Half divergence angles

OPK2-1-003	LUXEON Spot Base Module	3°
OPIO-1-011	Nichia Spot Base Module	11°
OPTX-1-006	Cree XLamp Spot Base Module	6°
OPGD-1-002	Osram Golden Dragon Spot Base Module	2°
OPK2-3-006	LUXEON Series Triple Spot Base Module	6°
OPIO-3-011	Nichia Triple Spot Base Module	11°
OPTX-3-008	Cree XLamp Triple Spot Base Module	8°
OPGD-3-006	OGD Triple Spot Base Module	6°

Sub-Lenses*

OPAA-1-DF	Single Spot Diffuser Sub-Lens	6°
OPAA-1-WSL	Single Wide Sub-Lens	12°
OPAA-1-OSL	Single Oval Sub-Lens	4° x 27°
OPTL - 3 - WSL	Triple Wide Sub-Lens	12°
OPTL - 3 - MSL	Triple Micro Sub-Lens	Micro

* Angles listed for sub-lenses are based upon LUXEON emitters & base modules.

Series 1
Series 3

L₂ Optics OPT Series 3



L₂Optics OPT Series 3 spot triple is fixed over the LEDs on the PCB using locating pegs.

The snap-lock sub-lenses attach easily, using locating pegs into the base lens.

Base Spot Lens

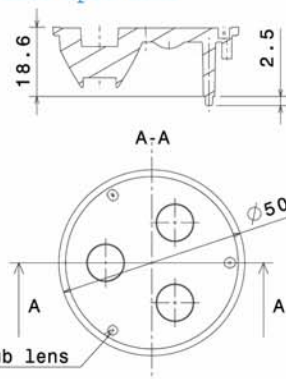

Base Spot + Sub Lens

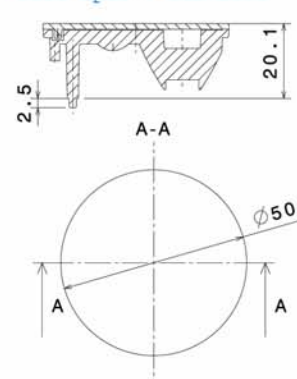

Fixing holes for additional sub lens

F-Form Lenses

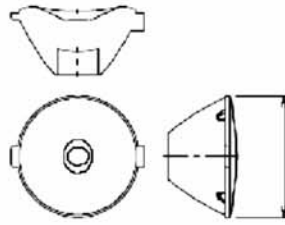

L₂Optics 20mm F-Form Series lenses, made from optical grade PMMA (acrylics) with an optical efficiency of 85% minimum. When used with the appropriate lens holders (below), these are suitable for LUXEON I, III, V & LUXEON® K2 and Osram Golden & Platinum Dragon.

Lens - Part Numbers

Half divergence angles

OP-005	20mm Series Spot Optic	5°
OP-015	20mm Series Medium Optic	15°
OP-025	20mm Series Wide Optic	25°
OP-520	20mm Series Oval Optic	5° x 20°

Lens Holders



There are different holders for Osram Golden & Platinum Dragons and various LUXEON emitters and stars. Each of these optic holders is available in clear, white or black.

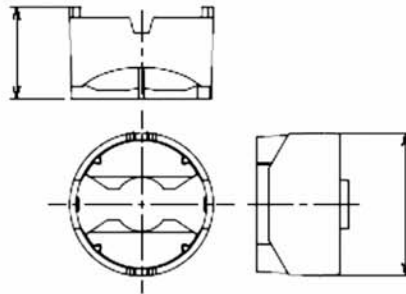

Optics - Part Numbers

OH-ES1-CL	Optic Holder - LUXEON I, III, V or Star 1W	Clear
OH-ES1-WH	Optic Holder - LUXEON I, III, V or Star 1W	White
OH-ES1-BK	Optic Holder - LUXEON I, III, V or Star 1W	Black
OH-S35-CL	Optic Holder - LUXEON Star III or V	Clear
OH-S35-WH	Optic Holder - LUXEON Star III or V	White
OH-S35-BK	Optic Holder - LUXEON Star III or V	Black
OH-K2-CL	Optic Holder - LUXEON K2 Emitter	Clear
OH-K2-WH	Optic Holder - LUXEON K2 Emitter	White
OH-K2-BK	Optic Holder - LUXEON K2 Emitter	Black
OH-GD-CL	Optic Holder - Osram Golden Dragon	Clear
OH-GD-WH	Optic Holder - Osram Golden Dragon	White
OH-GD-BK	Optic Holder - Osram Golden Dragon	Black
OH-PD-CL	Optic Holder - Platinum Dragon	Clear
OH-PD-WH	Optic Holder - Platinum Dragon	White
OH-PD-BK	Optic Holder - Platinum Dragon	Black



Special Lenses



The flare lens has been designed for use with all Emitters. The illumination pattern is horizontally very wide, but vertically extremely narrow - $\pm 10^\circ \times 80^\circ$

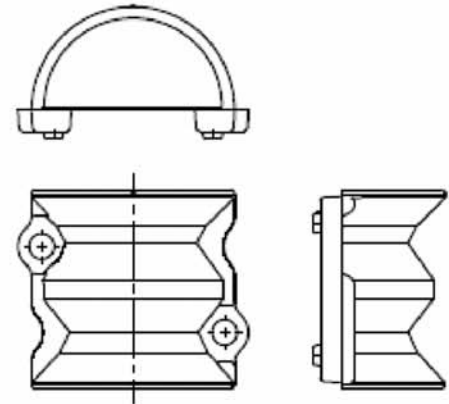

Flare Lens

OP-FL	Flare Lens	10° x 80°
-------	------------	-----------

Examples of other Special Lenses



3-Cell Optic



Side Emitting Lens



7-Cell Optic

Dialight Lumidrive is happy to design special customized lenses to meet your specific needs. Please contact us for a quotation.



Wiring Diagrams

Contents

36	Colordriver RFCC with Colorengine Circular and HL16RGB
37	Colordriver 36 with RGB LinkLEDs - or with multiple Colorengine Circular
38	Microdriver 9SC with Lumilights
38	Colordriver RFCC installation diagrams
39	Microdriver 9SC with Lumilines
40	Microdriver 9SC with Lumispots
41	LinkLEDs

Colordriver RF with Color Engine CE36 and HL16 RGB

CE18C-RGB-XXX

Typical Connection - With Color Engine 18



CE12C-RGB-XXX

Typical Connection - With Color Engine 12



Typical Connection Master/Slave - with Color Engine 18 & 4 X HL16 RGB

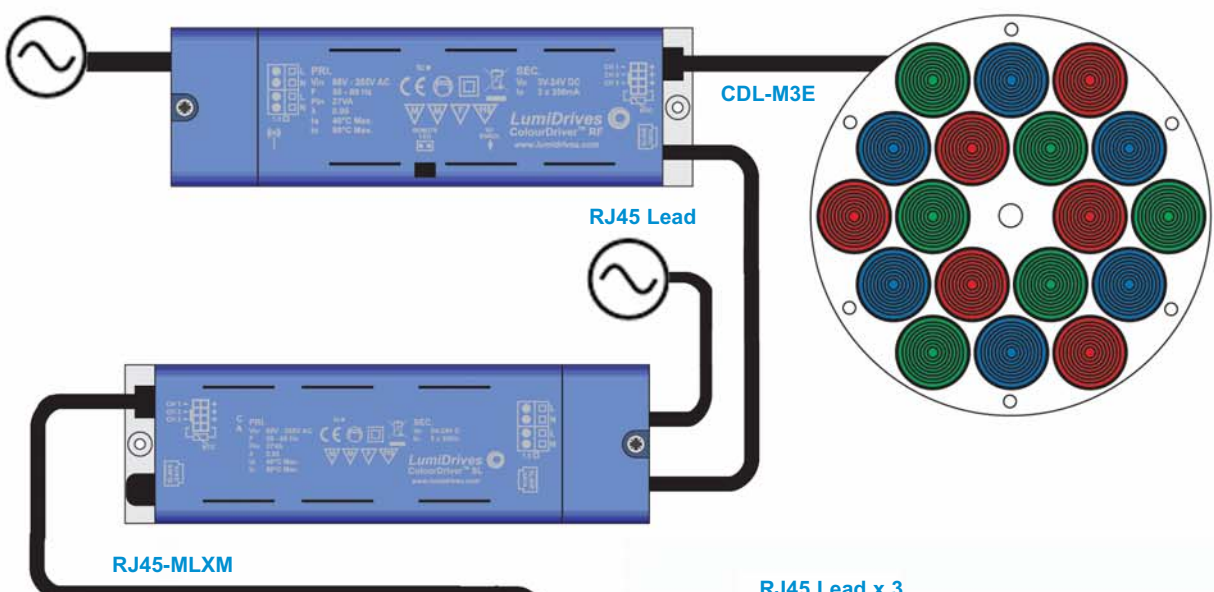

RJ45-MLXM

If longer than 100mm is required between color driver and first RJ45-CONN-ASSY, use CDL-M3M & RJ45-MLXF

RJ45-CONN-ASSY
Min 4 - Max 12

HL16-RGB
Min 1 - Max 6

RJ45 Lead x 3

End Termination
RJ45-C

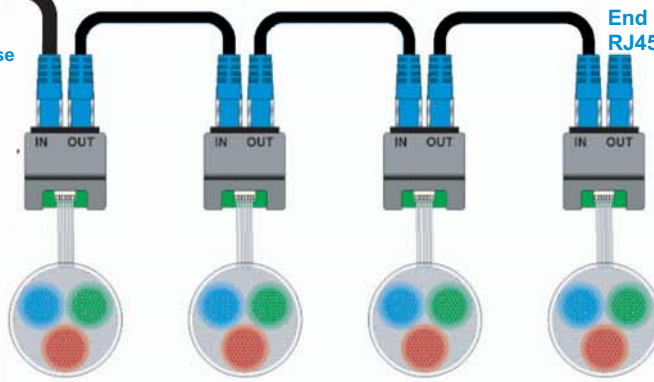

Colordriver 36 with RGB LinkLEDs™ or with multiple Color Engine Circular

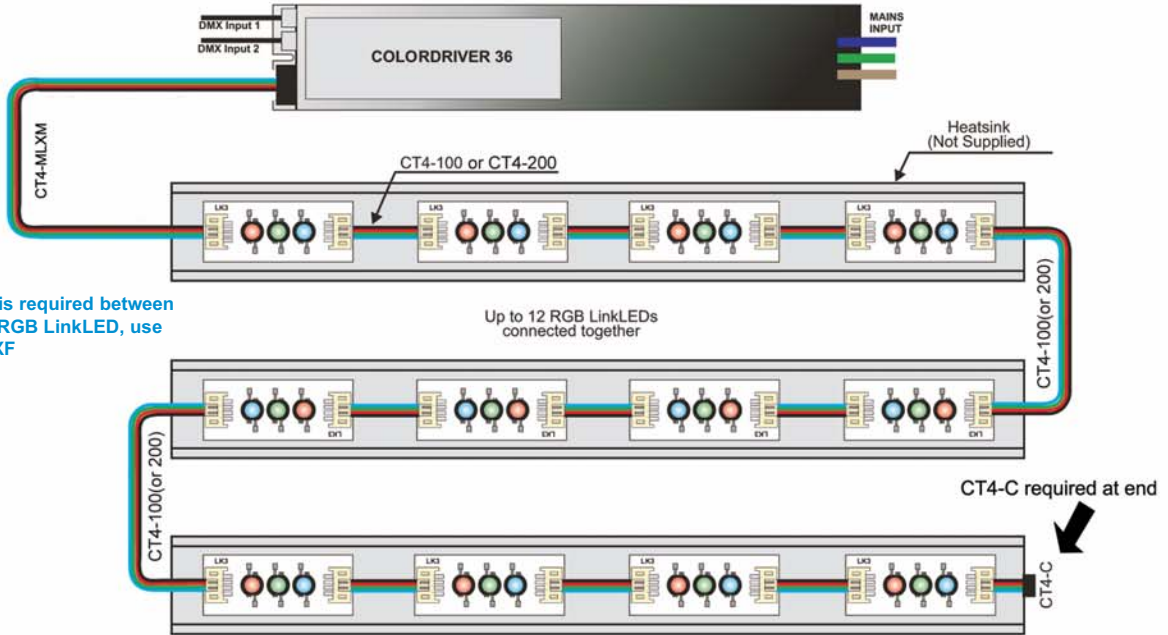

If longer than 100mm is required between Color Driver and first RGB LinkLED, use CDL-M3M & RJ45-MLXF

LinkLED-RGB Typical Connection

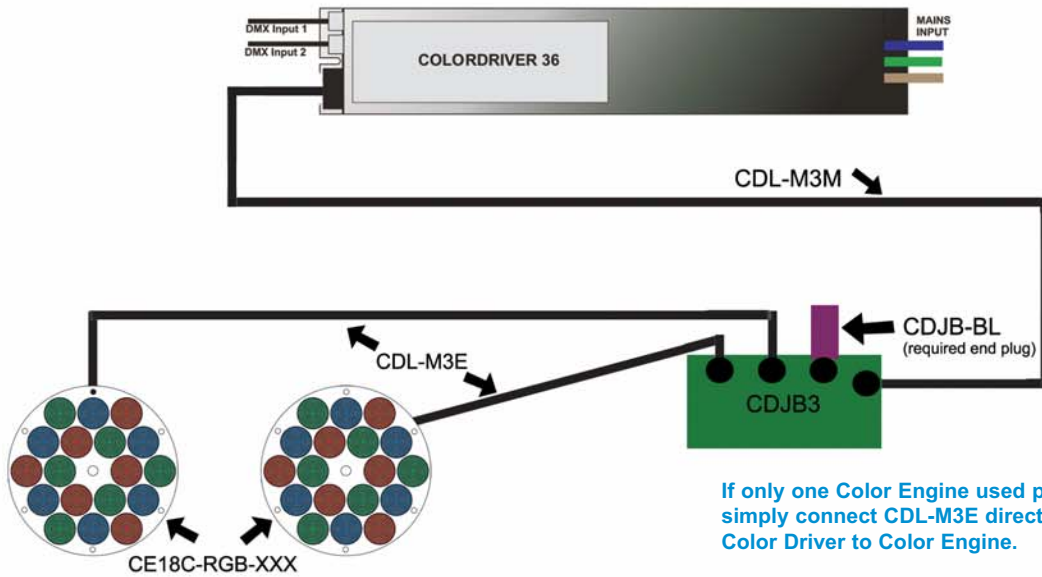

If only one Color Engine used per Color Driver, simply connect CDL-M3E directly from Color Driver to Color Engine.

Microdriver 9SC with Lumilights

Lumilight 3 - Typical Connection

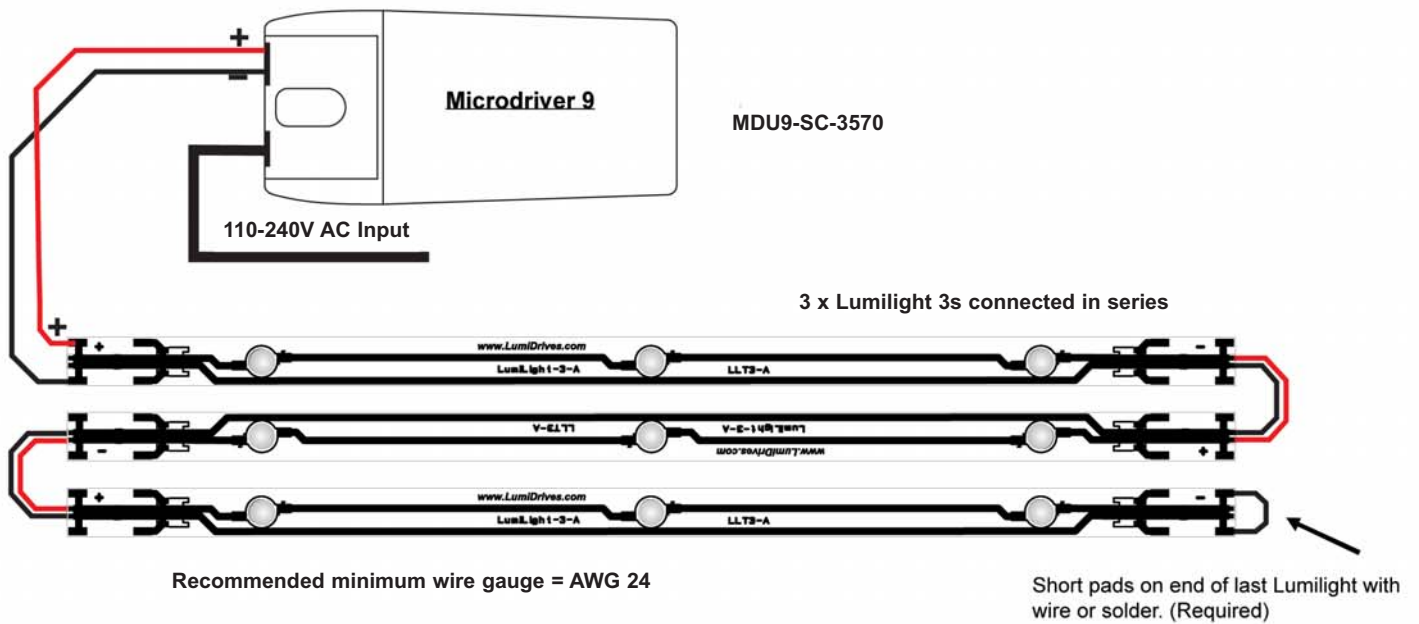

Colordriver RFCC Installation Diagrams

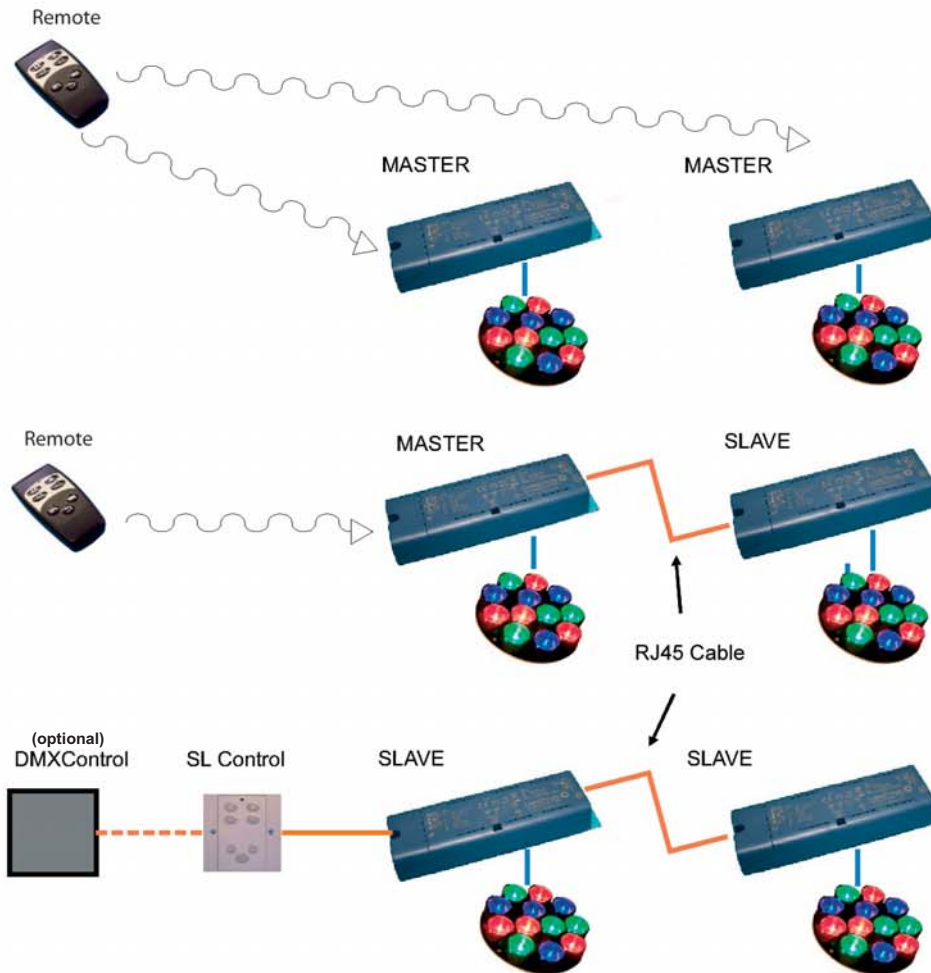

Microdriver 9SC with Lumilines

Lumiline 3 - Typical Connection

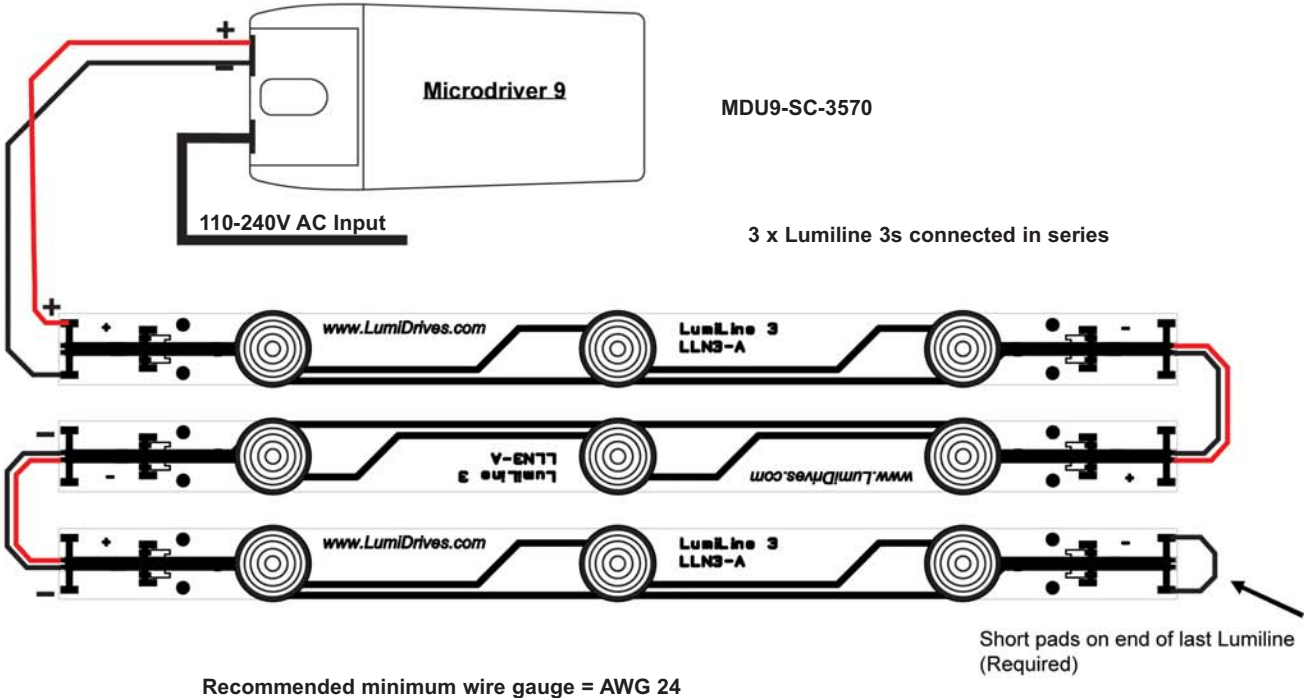

Lumiline 9 - Typical Connection

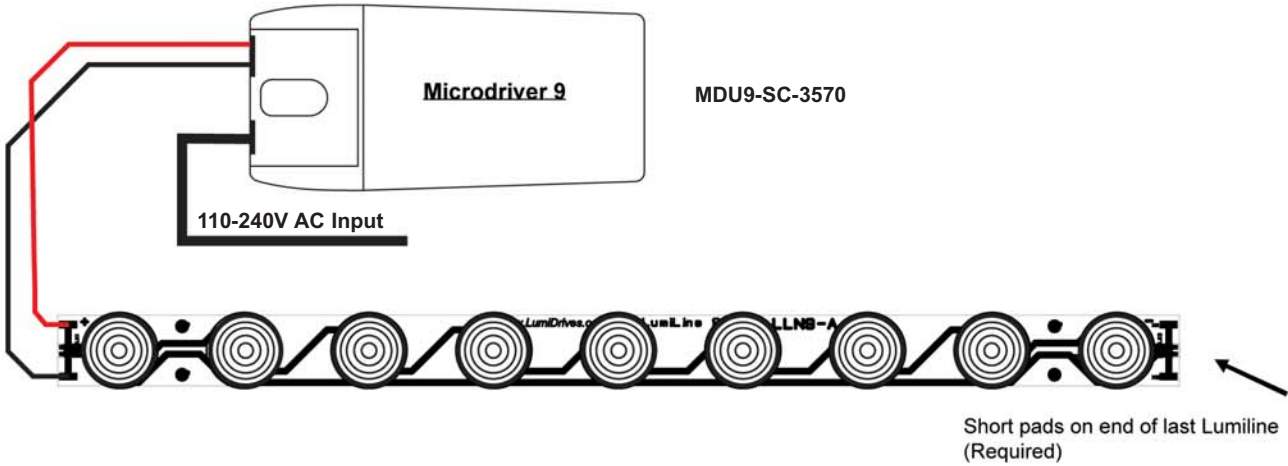

Microdriver 9SC with Lumispots

Lumispot 1 - Typical Connection

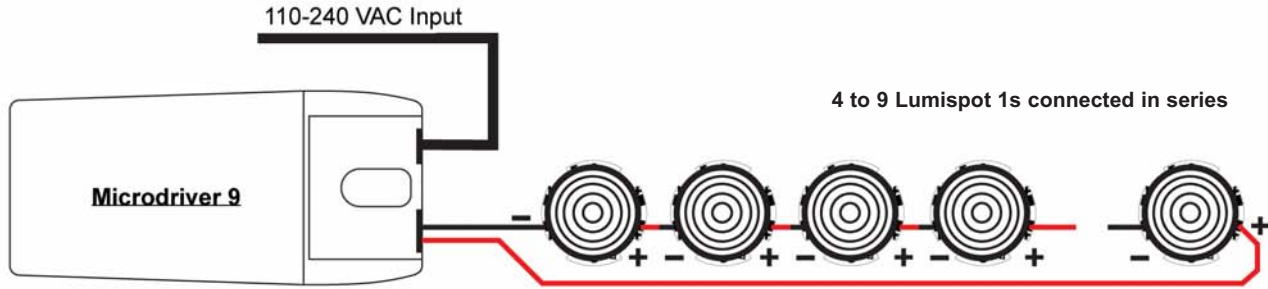

Lumispot 3 - Typical Connection

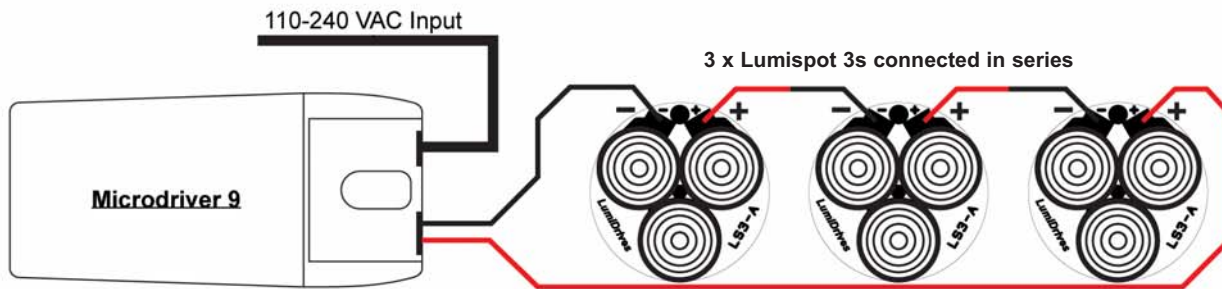



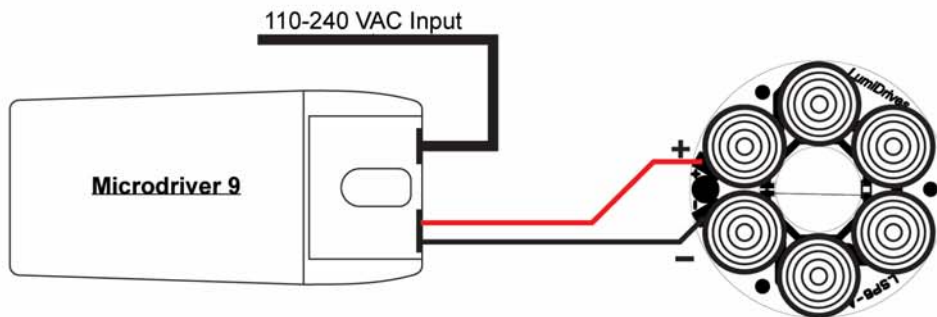

Lumispot 6 - Typical Connection

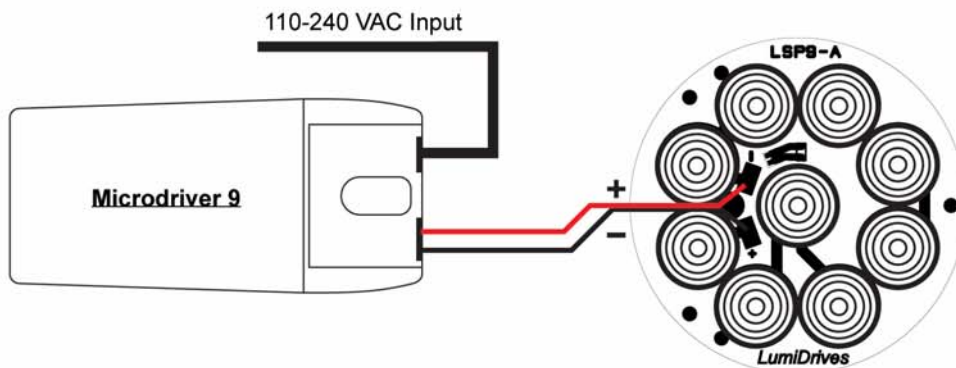

Lumispot 9 - Typical Connection



LinkLED™ Associated Cables

CT2-E300	2-way input lead	
CT2-100	2-way link lead 100mm	
CT2-200	2-way link lead 200mm	
CTC-C	2-way common connector	

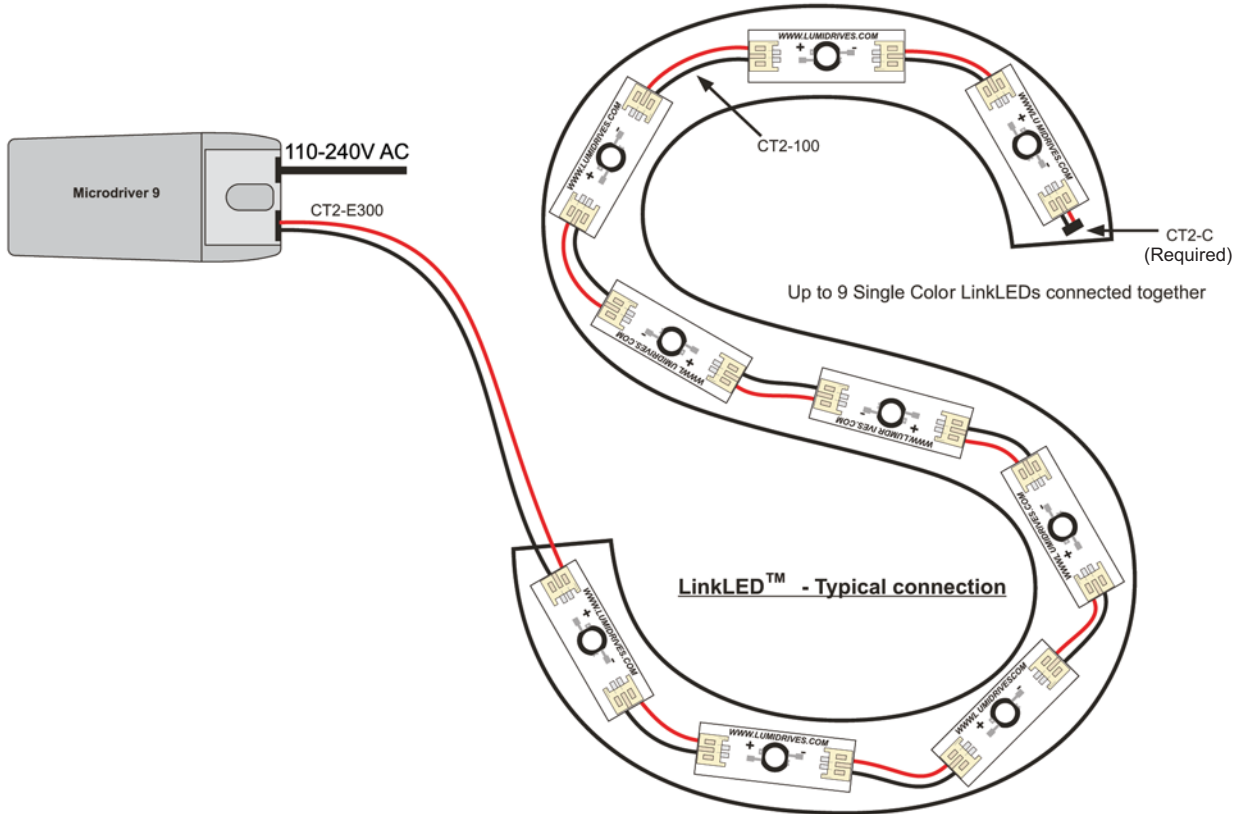

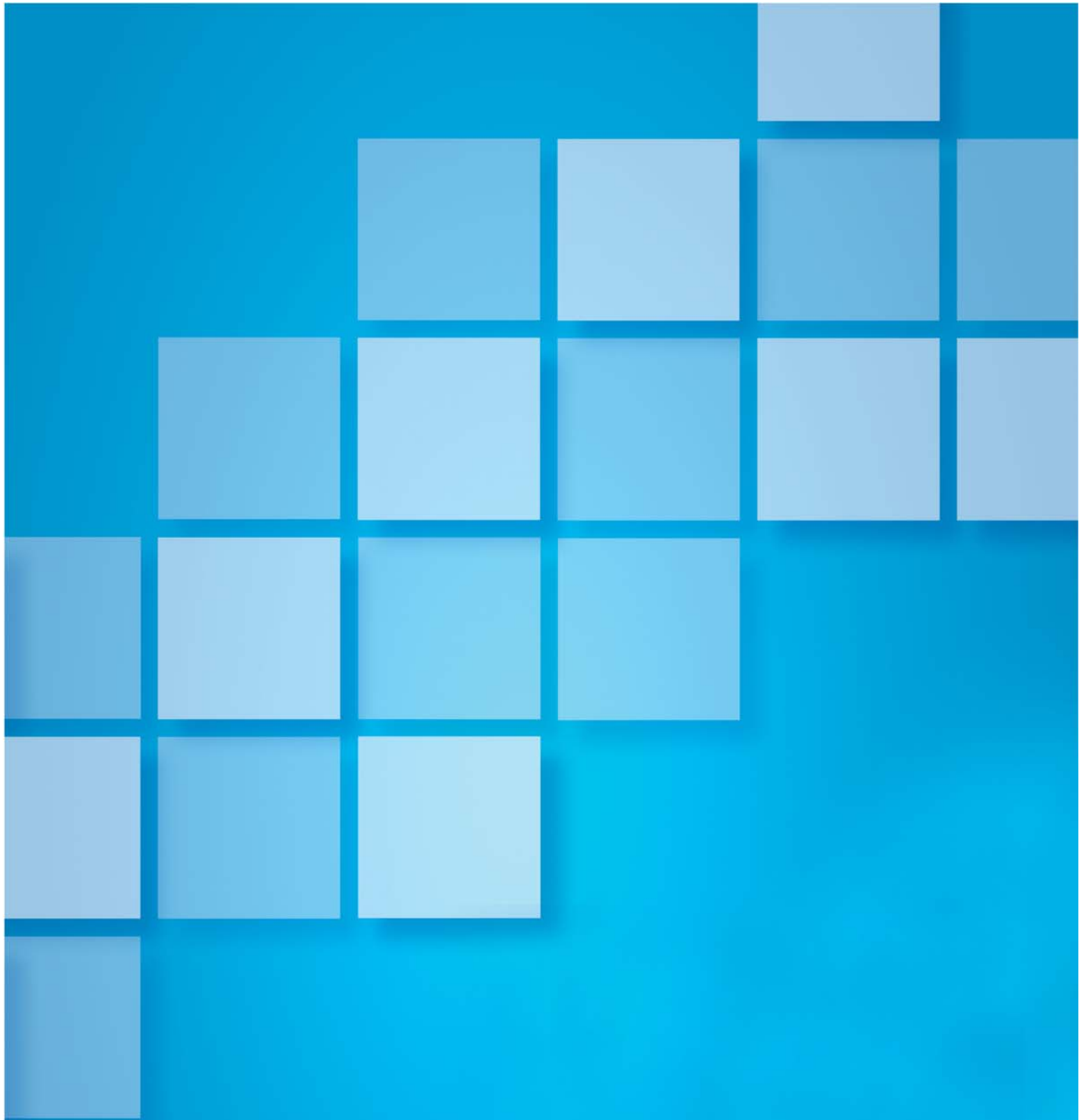

┌

└

└

┌

└