

# KAE SERIES DIP SWITCH

ANTI-VANDAL SWITCHES  
 DETECTOR SWITCHES  
 DIP SWITCHES  
 KEYLOCK SWITCHES  
 NAVIGATION SWITCHES  
 PUSHBUTTON SWITCHES  
 ROCKER SWITCHES  
 ROTARY SWITCHES  
 SLIDE SWITCHES  
 SNAP ACTION SWITCHES  
 TACTILE SWITCHES  
 TOGGLE SWITCHES  
 CAP OPTIONS

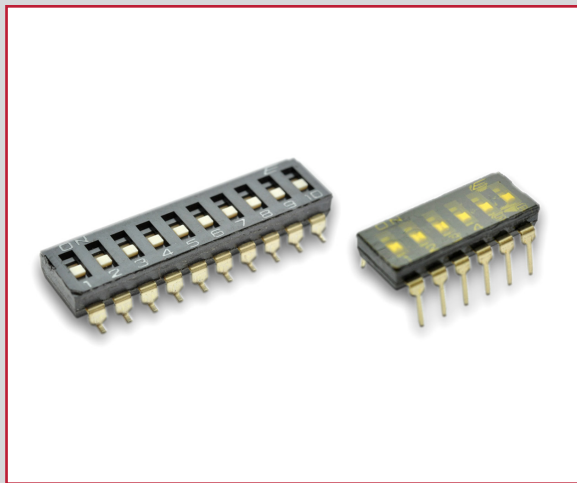

## APPLICATIONS / MARKETS

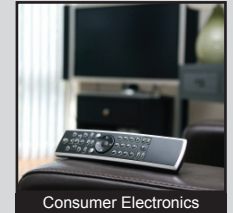
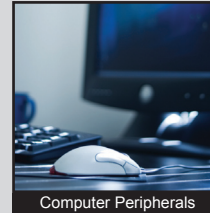

**RoHS**

## SPECIFICATIONS

**Electrical Rating:** 100mA @ 50VDC Non-Switching  
 25mA @ 24VDC Switching  
**Life Expectancy:** 2,000 Cycles  
**Contact Resistance:** 50mΩ Max.  
**Insulation Resistance:** 100 MΩ Min. at 500VDC  
**Dielectric Strength:** 500VAC for 1 min.  
**Operating Temperature:** -20°C to 85°C  
**Storage Temperature:** -40°C to 85°C  
**Travel:** 1.0mm nominal  
**Contact Arrangement:** SPST each position

## FEATURES & BENEFITS

- Splayed, straight pins, or gullwing termination
- Packaging options include Tube or Tape & Reel
- Top tape seal option with recessed actuator
- Low profile
- Up to 12 positions
- Gold contacts
- Switches are supplied in "OFF" position

## PART NUMBER CONFIGURATOR

Series	No. of Positions	Actuator	Termination	Contact Material	Packaging
<input type="text" value="KAE"/>	<input type="text" value="01"/> <input type="text" value="02"/> <input type="text" value="03"/> <input type="text" value="04"/> <input type="text" value="05"/> <input type="text" value="06"/> <input type="text" value="07"/> <input type="text" value="08"/> <input type="text" value="09"/> <input type="text" value="10"/> <input type="text" value="12"/>	<input type="text" value="L"/> <input type="text" value="S"/> <input type="text" value="T"/>	<input type="text" value="A"/> <input type="text" value="H"/> <input type="text" value="G"/>	<input type="text" value="G"/>	<input type="text" value="T"/> <input type="text" value="R"/>
	01 - 1 position 02 - 2 positions 03 - 3 positions 04 - 4 positions 05 - 5 positions 06 - 6 positions 07 - 7 positions 08 - 8 positions 09 - 9 positions 10 - 10 positions 12 - 12 positions	L - Extended S - Recessed without top tape seal T - Recessed with top tape seal	A - Splayed H - Straight G - Gullwing	G - Gold	T - Tube R - Tape & Reel

*Specifications subject to change without notice*



**E-SWITCH®**

www.e-switch.com

800.867.2717

2

## STRAIGHT PIN TERMINALS

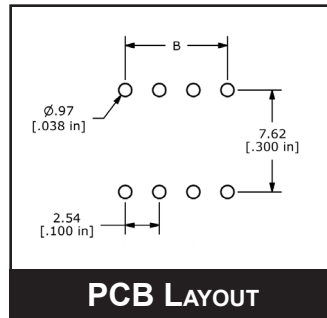
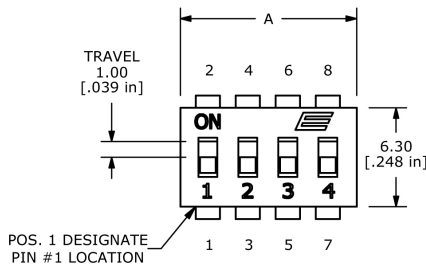

POSITIONS	DIM A	DIM B
1	3.58 [.141 in]	N/A
2	6.12 [.241 in]	2.54 [.100 in]
3	8.66 [.341 in]	5.08 [.200 in]
4	11.20 [.441 in]	7.62 [.300 in]
5	13.74 [.541 in]	10.16 [.400 in]
6	16.28 [.641 in]	12.70 [.500 in]
7	18.82 [.741 in]	15.24 [.600 in]
8	21.36 [.841 in]	17.78 [.700 in]
9	23.90 [.941 in]	20.32 [.800 in]
10	26.44 [1.041 in]	22.86 [.900 in]
12	31.52 [1.241 in]	27.94 [1.100 in]

POSITIONS CHART

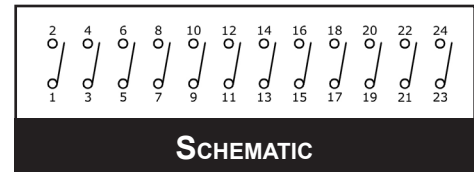
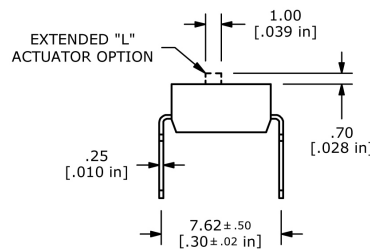
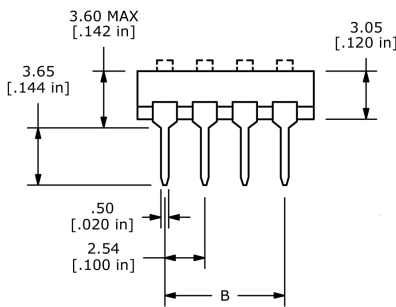

SCHEMATIC

## SPLAYED PIN TERMINALS

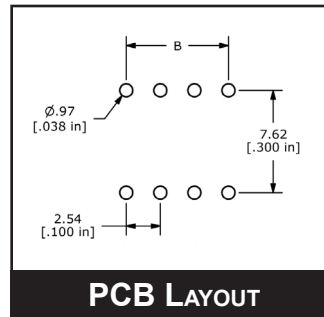
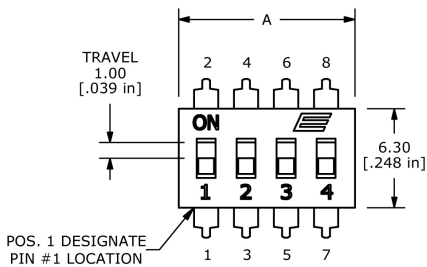

POSITIONS	DIM A	DIM B
1	3.58 [.141 in]	N/A
2	6.12 [.241 in]	2.54 [.100 in]
3	8.66 [.341 in]	5.08 [.200 in]
4	11.20 [.441 in]	7.62 [.300 in]
5	13.74 [.541 in]	10.16 [.400 in]
6	16.28 [.641 in]	12.70 [.500 in]
7	18.82 [.741 in]	15.24 [.600 in]
8	21.36 [.841 in]	17.78 [.700 in]
9	23.90 [.941 in]	20.32 [.800 in]
10	26.44 [1.041 in]	22.86 [.900 in]
12	31.52 [1.241 in]	27.94 [1.100 in]

POSITIONS CHART

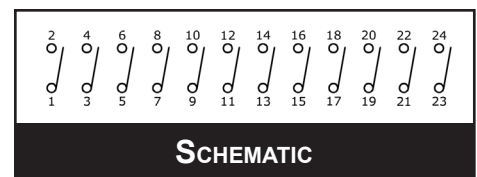
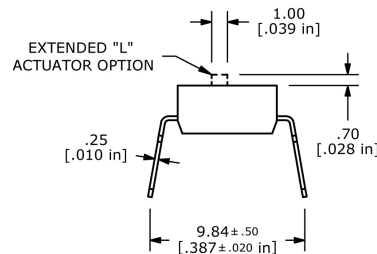
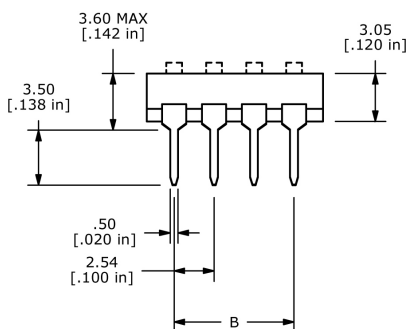

SCHEMATIC



## GULLWING TERMINALS

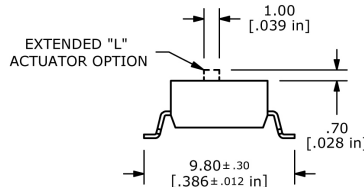
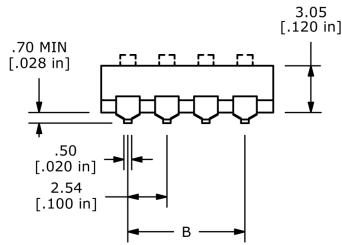
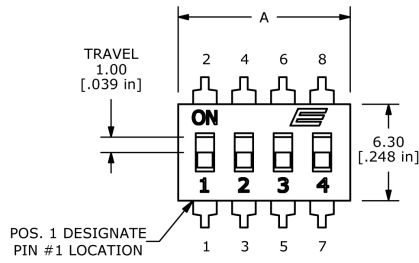

2-12 POSITIONS

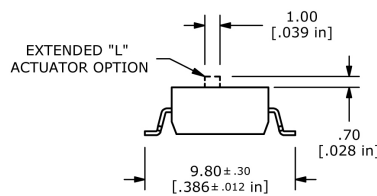
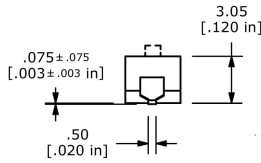

1 POSITION

POSITIONS	DIM A	DIM B
1	3.58 [.141 in]	N/A
2	6.12 [.241 in]	2.54 [.100 in]
3	8.66 [.341 in]	5.08 [.200 in]
4	11.20 [.441 in]	7.62 [.300 in]
5	13.74 [.541 in]	10.16 [.400 in]
6	16.28 [.641 in]	12.70 [.500 in]
7	18.82 [.741 in]	15.24 [.600 in]
8	21.36 [.841 in]	17.78 [.700 in]
9	23.90 [.941 in]	20.32 [.800 in]
10	26.44 [1.041 in]	22.86 [.900 in]
12	31.52 [1.241 in]	27.94 [1.100 in]

POSITIONS CHART

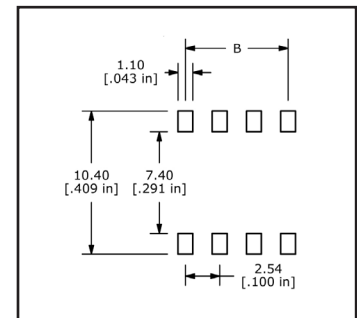

SMT PCB LAYOUT

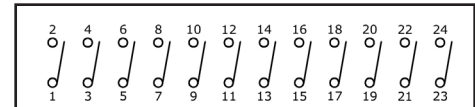

SCHEMATIC

