

# SERIES LC SWITCHES

## PUSHBUTTON SWITCHES

TACT SWITCHES

NAVIGATION SWITCHES

PUSHBUTTON SWITCHES

TOGGLE SWITCHES

ROCKER SWITCHES

SLIDE SWITCHES

SNAP-ACTION SWITCHES

DIP SWITCHES

KEYLOCK SWITCHES

ROTARY SWITCHES

DETECTOR SWITCHES

CAP OPTIONS



### FEATURES & BENEFITS

- ▶ Latching & momentary functions
- ▶ Shorting or non-shorting versions
- ▶ Variety of housing styles available

### APPLICATIONS/MARKETS

- ▶ Telecommunications
- ▶ Networking
- ▶ Computers/servers
- ▶ Performance audio
- ▶ Instrumentation
- ▶ Low power on/off designs
- ▶ External hard drives and modems

### SPECIFICATIONS

Contact Rating:	300mA @ 30 VDC
Life Expectancy:	10,000 cycles typical
Contact Resistance:	20mΩ max. initial @ 2-4 VDC, 100mA
Insulation Resistance:	100MΩ min.
Dielectric Strength:	1,000 V rms @ sea level
Actuation Force:	Dependent upon model number
Operating Temperature:	-20° to + 85°C

### MATERIALS

Housing:	Tin over Steel
Actuator:	Acetal
Terminal Base:	Phenolic
Spring:	Spring steel
Terminals:	Silver over brass
Contacts:	Silver over phosphor bronze

### HOW TO ORDER

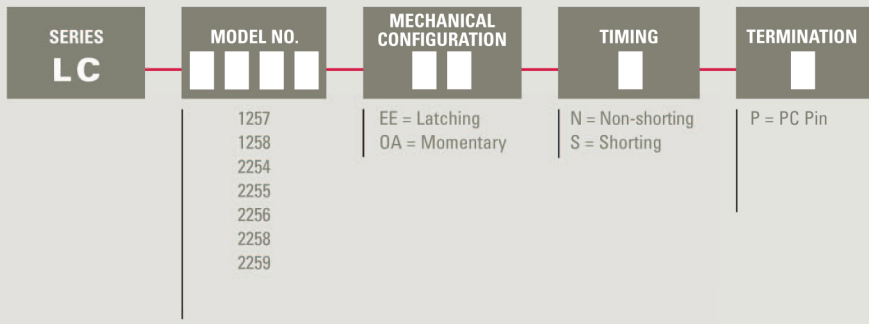

▶ ▶ ▶ **Example Ordering Number**  
 LC-1257-EE-N-P

Specifications subject to change without notice.

### ACTUATION OPTIONS

Model No.	Actuation Force
1257	230 ± 100 gf
1258	230 ± 100 gf
2254	300 ± 150 gf
2255	300 ± 150 gf
2256	300 ± 150 gf
2258	330 ± 100 gf
2259	330 ± 100 gf



### LC 1257

Shaft End Style A

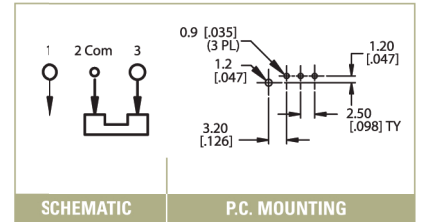
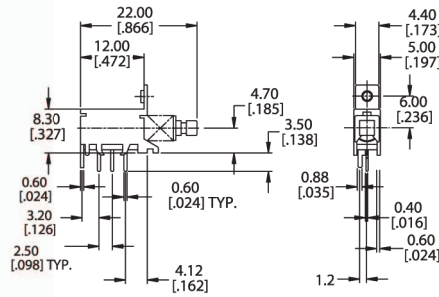
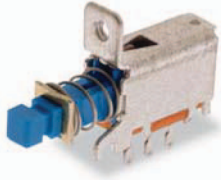

### LC 1258

Shaft End Style A

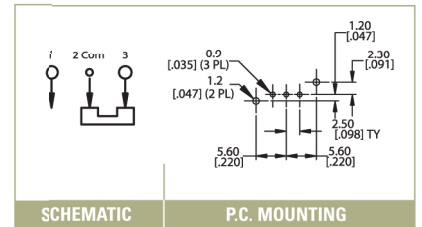
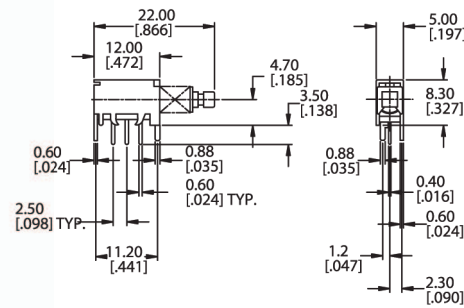
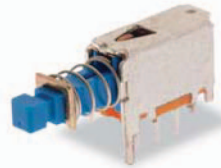

### LC 2254

Shaft End Style □2.7mm

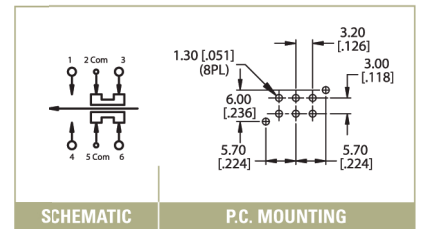
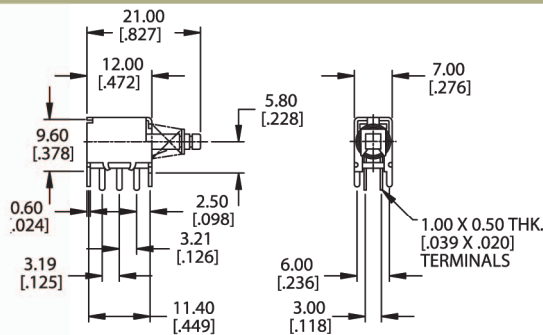

### LC 2255

Shaft End Style B

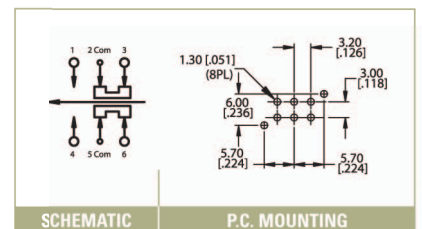
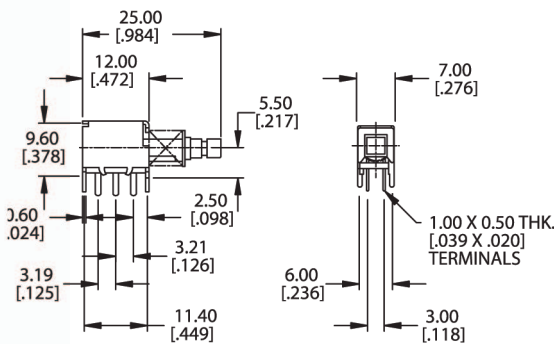

TACT SWITCHES  
NAVIGATION SWITCHES  
PUSHBUTTON SWITCHES  
TOGGLE SWITCHES  
ROCKER SWITCHES  
SLIDE SWITCHES  
SNAP-ACTION SWITCHES  
DIP SWITCHES  
KEYLOCK SWITCHES  
ROTARY SWITCHES  
DETECTOR SWITCHES  
CAP OPTIONS



# SERIES LC SWITCHES

## PUSHBUTTON SWITCHES

TACT SWITCHES

NAVIGATION SWITCHES

PUSHBUTTON SWITCHES

TOGGLE SWITCHES

ROCKER SWITCHES

SLIDE SWITCHES

SNAP-ACTION SWITCHES

DIP SWITCHES

KEYLOCK SWITCHES

ROTARY SWITCHES

DETECTOR SWITCHES

CAP OPTIONS

### LC 2256

#### Shaft End Style B

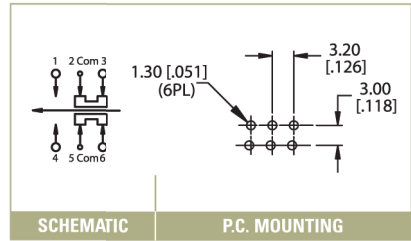
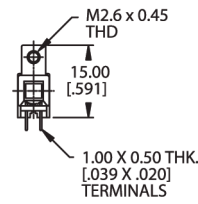
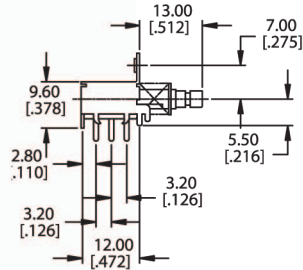

### LC 2258

#### Shaft End Style A

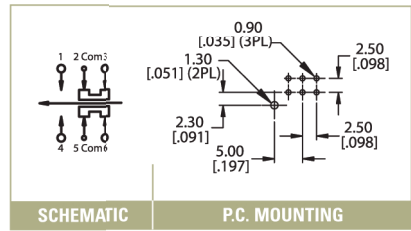
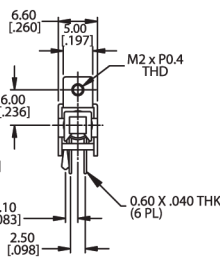
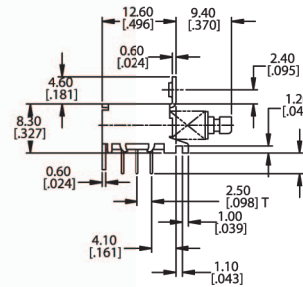

### LC 2259

#### Shaft End Style A

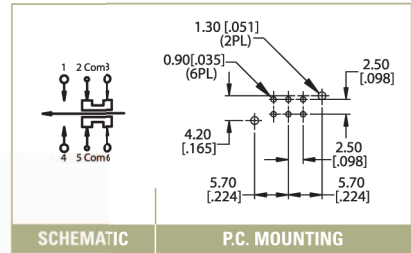
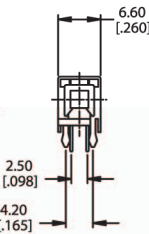
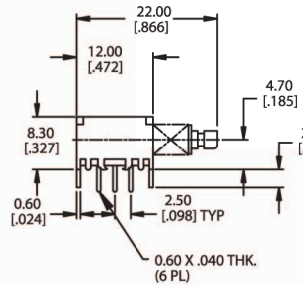

### SHAFT END STYLES

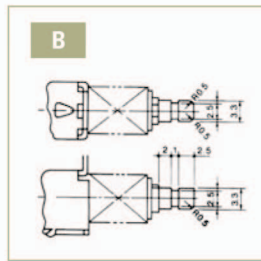
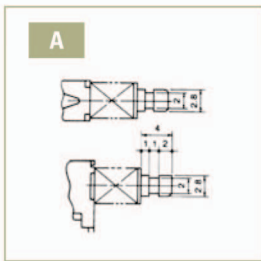

### TERMINATION OPTIONS

