

ANTI-VANDAL SWITCHES
 DETECTOR SWITCHES
 DIP SWITCHES
 KEYLOCK SWITCHES
 NAVIGATION SWITCHES
 PUSHBUTTON SWITCHES
 ROCKER SWITCHES
 ROTARY SWITCHES
 SLIDE SWITCHES
 SNAP ACTION SWITCHES
 TACTILE SWITCHES
 TOGGLE SWITCHES
 CAP OPTIONS

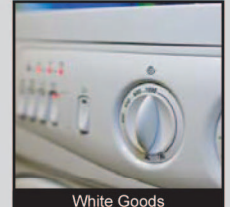

APPLICATIONS / MARKETS

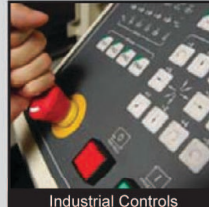
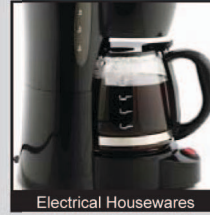

RoHS

SPECIFICATIONS

Electrical Rating: 16(16)A 125VAC 5E4 T85 [cURus]
 1/3HP 125VAC IP66 [cURus]
 10(10)A 250VAC 5E4 T85 [VDE]

Electrical Life: 50,000 Cycles

Mechanical Life: 50,000 Cycles

Contact Resistance: <30mΩ Max.

Insulation Resistance: 500MΩ Min. at 500VDC

Dielectric Strength: 1000VAC for 1 Minute

Operating Temperature: -20°C to 85°C Min.

Ingress Protection: IP66

Panel Cutout: 22mm x 30mm

Function: DPST, Off-On
 DPDT, On-On

FEATURES & BENEFITS

- Full illumination options available
- Approved under new UL 61058-1 rating
- UL approved up to 1/3HP
- Internally sealed to an IP66 rating using patented technology (Patent No.: US 7,872,205 B2)

PART NUMBER CONFIGURATOR

Series	Circuit	Body Color	Actuator Color	Marking	Termination	Lamp Voltage
RBW2	A - Off-On (DPST) *B - On-On (DPDT)	BLK - Black WHT - White	BLK - Black WHT - White RED - Red RIL - Red Full Illum. GIL - Green Full Illum. YIL - Yellow Full Illum. BIL - Blue Full Illum.	A - Dot D - I/II Vertical F - I/O Vertical G - I/O Horizontal I - On/Off Vertical E - No Marking	F - 6.3mm Tab	0 - No Lamp 1 - 125VAC Neon 2 - 250VAC Neon 3 - 12VDC Incandescent

* Not available with illumination

Specifications subject to change without notice



BODY DIMENSIONS

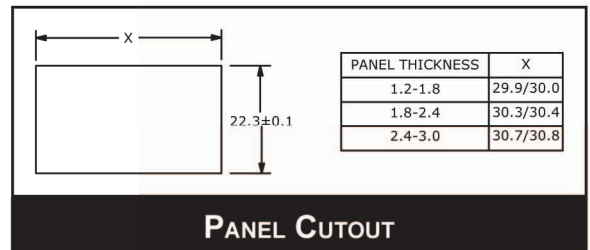
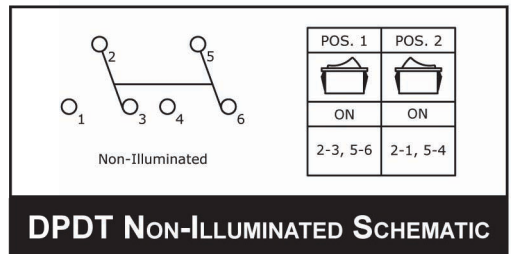
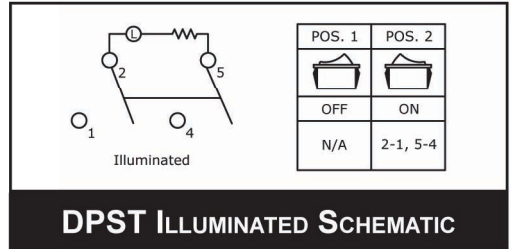
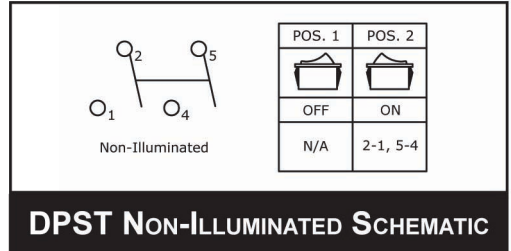
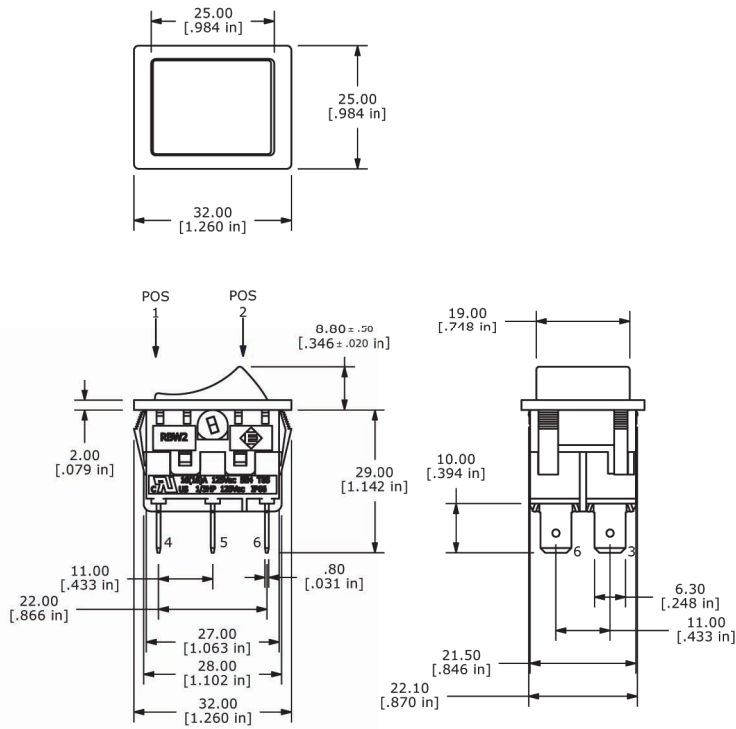

MARKINGS

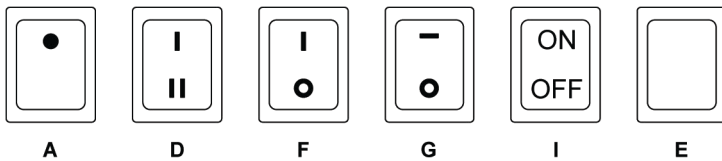

ANTI-VANDAL SWITCHES
 DETECTOR SWITCHES
 DIP SWITCHES
 KEYLOCK SWITCHES
 NAVIGATION SWITCHES
 PUSHBUTTON SWITCHES
 ROCKER SWITCHES
 ROTARY SWITCHES
 SLIDE SWITCHES
 SNAP ACTION SWITCHES
 TACTILE SWITCHES
 TOGGLE SWITCHES
 CAP OPTIONS

