

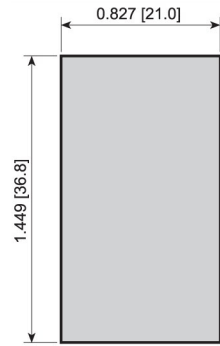

ROCKER

Panel Cutout

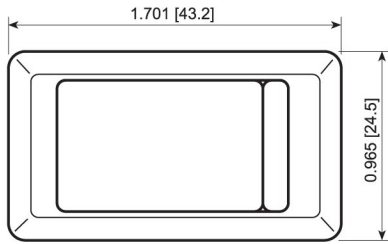

Terminal Options

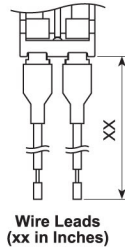
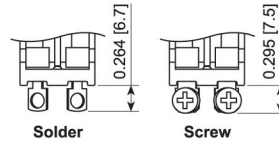
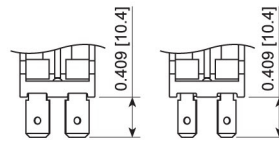

FEATURES:

- Heavy Duty Ratings with cURus Approval
- Full Size Rocker Switch
- Internal Dust and Water Protection to IP54
- Glossy Finish Option

SPECIFICATIONS:

- RATING:** MAINTAINED SWITCHES:
 20A 125VAC [cURus UL508]
 15A 277VAC [cURus UL508]
 2HP 125-250VAC [cURus UL508]
- MOMENTARY SWITCHES:**
 20A 125VAC [cURus UL508]
 15A 277VAC [cURus UL508]
 1.5HP 125-250VAC [cURus UL508]

- TEMPERATURE:** -20°C to 55°C
ELECTRICAL LIFE: 6,000 Cycles [cURus]
CONTACT RESISTANCE: 50mΩ Max.
INSULATION RESISTANCE: 800MΩ Min. at 500VDC
DIELECTRIC STRENGTH: 1,500VAC for 1 Minute
INGRESS PROTECTION: IP54 Standard

MATERIALS:

- Body:** Polyamide 6/6, UL94 V-2
ACTUATOR: Polyamide 6/6, UL94 V-2
CONTACTS: Silver Alloy
TERMINALS: Brass
 Silver Plated Brass

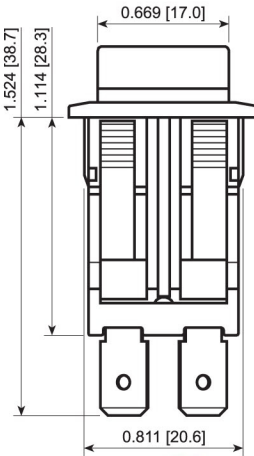
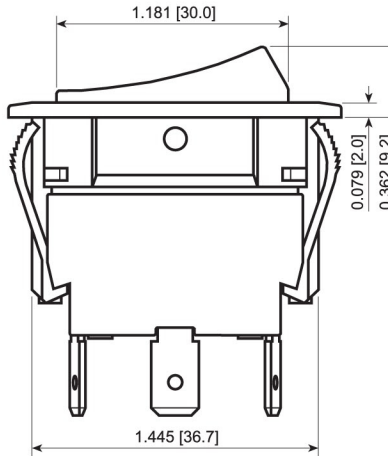

RVW52D1100

RVW46D1122

RVWW6Z02D1100



RVW42D2223

SPECIFICATIONS SUBJECT TO CHANGE WITHOUT NOTICE

Series	Terminal	Function	Rating	Body Color	Actuator Color	Marking Color	Marking Type
RVW - Matte Finish RVWG - Glossy Finish	1 - 4.8mm Tabs 4 - 6.3mm Tabs 5 - Solder 6 - Screw	1 Pole: 1 - Off-On 3 - On-On 4 - Off-(On) 5 - On-Off-On A - On-(Off) B - On-(On) C - On-Off-(On) D - (On)-Off-(On)	D - 20A 125VAC	1 - Black 2 - White 3 - Almond 4 - Grey 9 - Red	1 - Black 2 - White 3 - Almond 4 - Grey 5 - Orange 7 - Blue 8 - Green 9 - Red	0 - None 1 - Black 2 - White 8 - Red	0 - None 1 - I/O Vert. 2 - ON/OFF/ON Vert. 3 - ON/OFF Vert. 4 - ON/OFF Horiz. 9 - I/O/III Horiz. S - I/O/III Vert. R - I/O Horiz.
	Variable Length: Wxx - Wire Leads	2 Pole: 2 - Off-On G - On-On E - Off-(On) 6 - On-Off-On F - On-(Off) H - On-(On) J - On-Off-(On) K - (On)-Off-(On)		Custom Colors and Markings Available Upon Request			

Note:
Terminal bridging options available. See "Z02" function for polarity reversal in example photo.

EXAMPLE PART NUMBERS:

- RVW41D1100 1P Off-On
Black Body/Actuator, No Marking
- RVW42D1100 2P Off-On
Black Body/Actuator, No Marking
- RVW42D1121 2P Off-On
Black Body/Actuator, I/O Vert.
- RVW43D1100 1P On-On
Black Body/Actuator, No Marking
- RVW45D1100 1P On-Off-On
Black Body/Actuator, No Marking
- RVW46D1100 2P On-Off-On
Black Body/Actuator, No Marking
- RVW4GD1100 2P On-On
Black Body/Actuator, No Marking
- RVWG41D1100 1P Off-On
Glossy, Black Body/Actuator, No Marking
- RVWG42D1100 2P Off-On
Glossy Black Body/Actuator, No Marking

