

SERIES SS SWITCHES

SNAP ACTION SWITCHES - SUB-MINIATURE

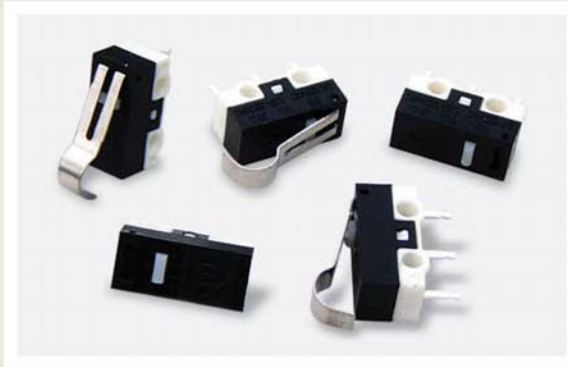

SPECIFICATIONS

Contact Rating:	Gold .4VA max. @ 20 VDC or VAC Max. 0.1 Amps @ 5 VDC 1.5 Amps @ 250-UL 3 Amps @ 125-UL
Life Expectancy:	10,000 cycles typical
Mechanical Life:	1,000,000 cycles typical
Insulation Resistance:	100 MΩ min. @ 500V DC
Dielectric Strength:	500VDC
Operating Temperature:	-25° C to 75°
Operating Force:	See Chart

MATERIALS

Switch Housing:	High Temperature PBT (UL94 V-0)
Actuator Button:	High Temperature PBT (UL94 V-0)
Terminals:	Copper Alloy, plated
Contacts:	Silver Alloy (std) or Gold
Spring:	Spring Steel

FEATURES & BENEFITS

- ▶ Subminiature package size
- ▶ Designed for higher reliability applications

APPLICATIONS/MARKETS

- ▶ Appliance
- ▶ Timing controls
- ▶ Vending machines
- ▶ Gaming
- ▶ Industrial controls

HOW TO ORDER

SERIES	OPERATING TEMP.	CURRENT RATING	ACTUATOR	OPERATING FORCE	TERMINATION	CIRCUIT
SS	075 = 75C	03 = 3A, 125VAC 1.5A, 250VAC Q1= 0.1A, 125VAC R1=0.4VA	00 01 02 03	See Chart	P1 = PCB Pins R1 = PCB Retention V1 = PCB Right Angle V2 = PCB Left Angle S1 = Solder Lug	A = SPDT

▶ ▶ ▶ Example Ordering Number
SS-075-03-01-F030-P1-A

Specifications subject to change without notice.

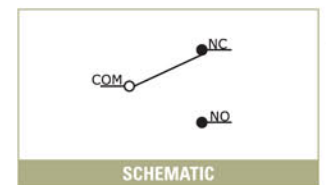
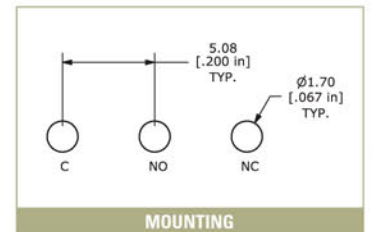
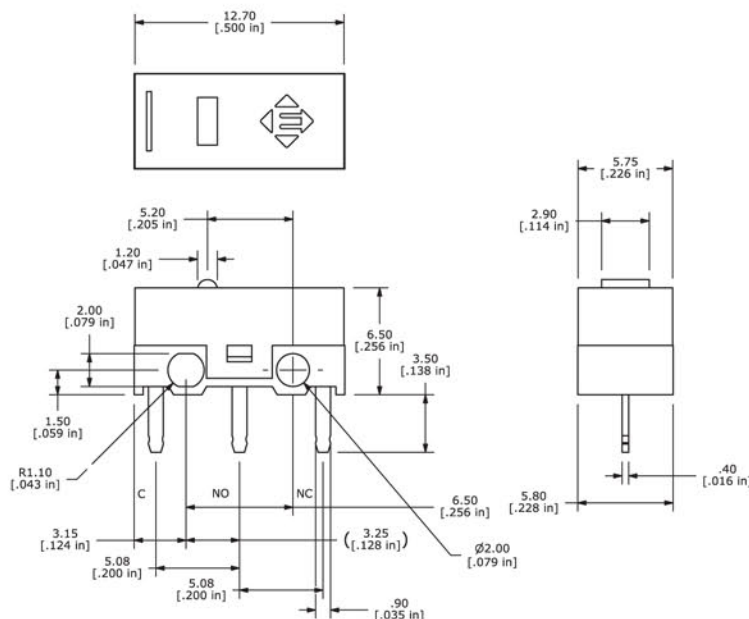



SERIES SS SWITCHES

SNAP ACTION SWITCHES - SUB-MINIATURE

TACT SWITCHES

NAVIGATION SWITCHES

PUSHBUTTON SWITCHES

TOGGLE SWITCHES

ROCKER SWITCHES

SLIDE SWITCHES

SNAP-ACTION SWITCHES

DIP SWITCHES

KEYLOCK SWITCHES

ROTARY SWITCHES

DETECTOR SWITCHES

CAP. OPTIONS

TERMINATION OPTIONS

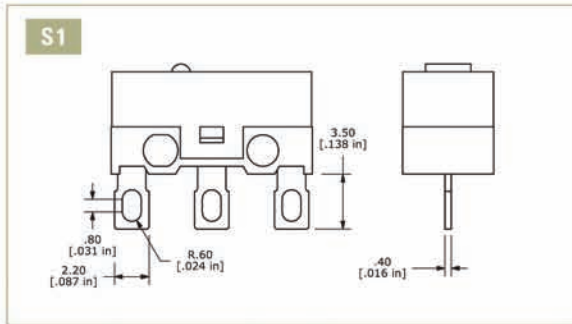
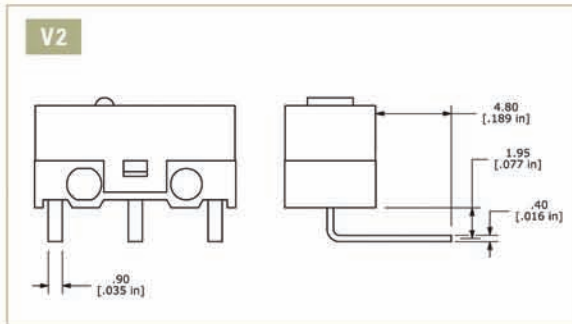
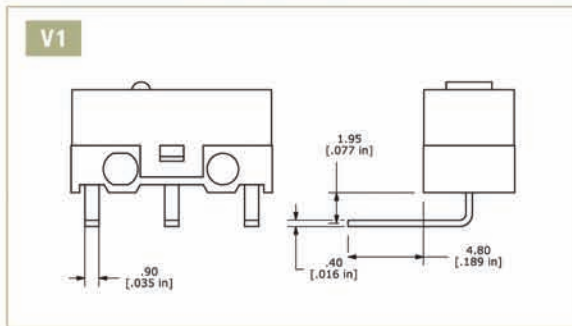
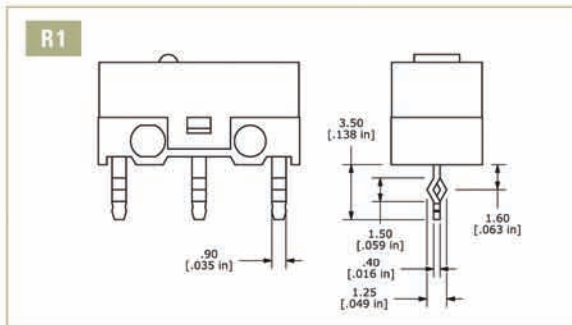
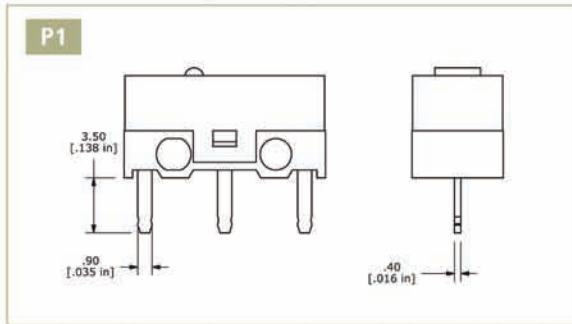

ACTUATOR OPTIONS

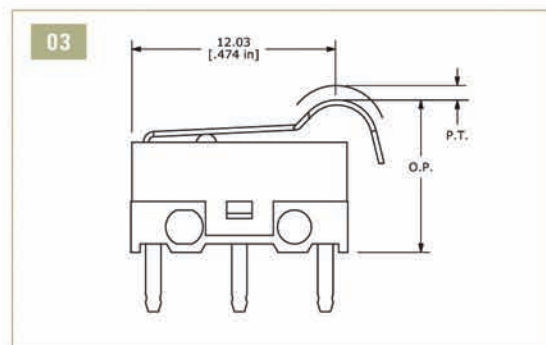
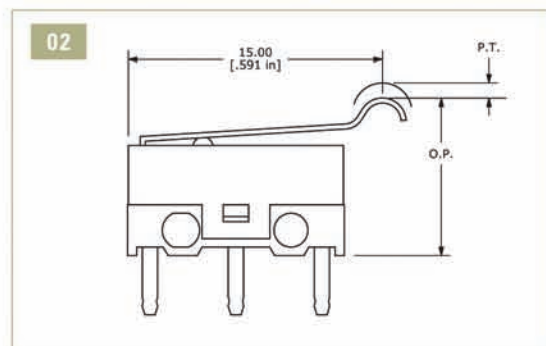
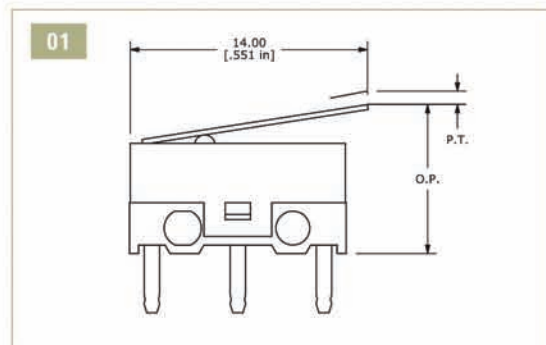
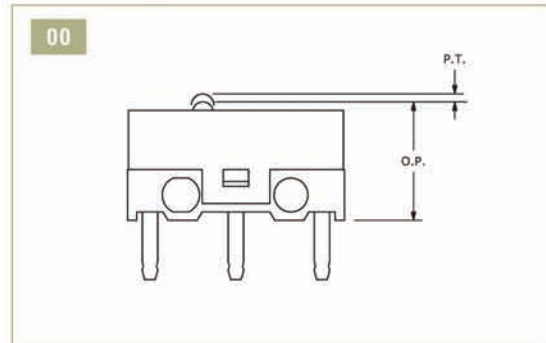

PT= Pretravel OP= Operating Point

ACTUATOR AND OPERATING FORCE CHART						
Actuator	Actuation/Return Force				Pre-Travel	Operating Point
00	070 / 25	090 / 40	110 / 50	130 / 60	0.35 Max	7.0 ± 0.2
01	020 / 5	030 / 10	035 / 10	040 / 15	1.60 Max	8.80 ± 0.8
02	015 / 5	025 / 10	030 / 10	035 / 10	2.00 Max	10.80 ± 0.8
03	020 / 5	030 / 10	040 / 15	050 / 15	1.35 Max	9.65 ± 0.8