

# SERIES D16, P16, L16 SWITCHES

## PUSHBUTTON SWITCHES - ILLUMINATED

TACT SWITCHES

NAVIGATION SWITCHES

PUSHBUTTON SWITCHES

TOGGLE SWITCHES

ROCKER SWITCHES

SLIDE SWITCHES

SNAP-ACTION SWITCHES

DIP SWITCHES

KEYLOCK SWITCHES

ROTARY SWITCHES

DETECTOR SWITCHES

CAP OPTIONS



### SPECIFICATIONS

Contact Rating:	5A@250 VAC-UL, VDE 8A@125 VAC - UL, CSA 6A@24 VDC - UL, CSA
Life Expectancy (Mechanical):	100,000 cycles
Life Expectancy (Electrical):	50,000 cycles
Contact Resistance:	100mΩ max. typical; initial @ 2-4 VDC
Insulation Resistance:	> 1,000MΩ
Dielectric Strength:	> 1,500 volts 1 minute > 3,000 volts between poles
Actuation Force:	300g/pole
Operating Temperature:	-20°C to 55°C

### FEATURES & BENEFITS

- ▶ Modular interface/contact block design
- ▶ Robust product for industrial applications
- ▶ Attractive front panel design
- ▶ Illuminated options available

### APPLICATIONS/MARKETS

- ▶ Industrial controls
- ▶ Instrumentation
- ▶ Transportation
- ▶ Telecommunications

### MATERIALS

Switch Housing:	Polyetherimide (PEI)
Contact Housing:	Diallyl Phthalate (DAP)
Lens:	Polycarbonate (PC)
Contacts:	Silver plated copper alloy
Terminals:	Silver plated copper alloy

### HOW TO ORDER

SERIES	MECHANICAL CONFIGURATION	PUSHBUTTON HEAD	CIRCUIT	LAMP TYPE & VOLTAGE	LAMP COLOR (WHERE APPLICABLE)	LENS COLOR
D16 = Solder Lug  P16 = Socket  L16 = Pilot Indicator	EE = Latching  OA = Momentary  PL* = Pilot Indicator  *For L16 (Pilot Indicator)	S1 S2 T1 T2 R* R1  *R (Mushroom Head) Available for D16 & P16 Only.	0* = Pilot Ind. 1**= SPDT 2 = DPDT 3 = 3PDT 4 = 4PDT  *For L16 only (Pilot Indicator)  **P16 available SPDT only	0 = None A B C F G  H J K  M N L D E	F   Red G   Grn  H   Red J   Grn K   Yel	RED= Red GRN= Green BLU= Blue* WHT= White* ORG= Orange* YEL= Yellow*  *Not Available For 'R' Mushroom Head.

▶ ▶ ▶ **Example Ordering Number**  
D16-EE-R1-3-A-BLU

Specifications subject to change without notice.



# SERIES D16 SWITCHES

## PUSHBUTTON SWITCHES - ILLUMINATED

### D16 (SOLDER LUG)

R

MUSHROOM



PANEL MOUNTING

### D16 (SOLDER LUG)

R1

ROUND

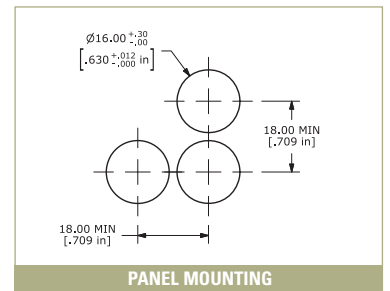
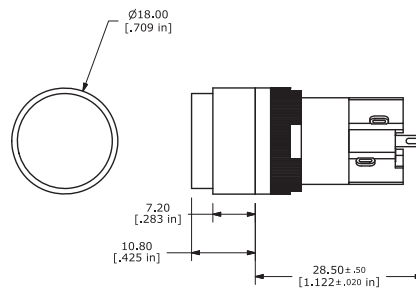

PANEL MOUNTING

### D16 (SOLDER LUG)

S1

SQUARE

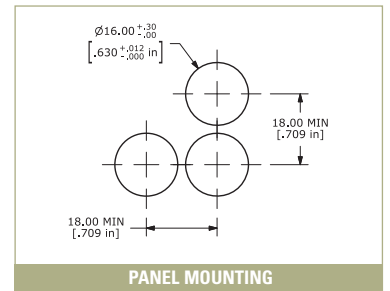
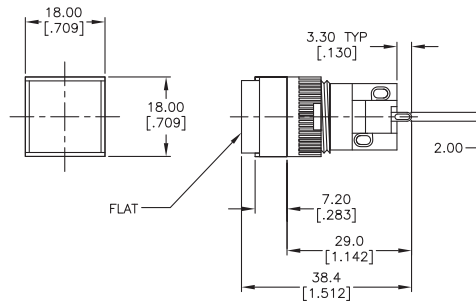

PANEL MOUNTING

### D16 (SOLDER LUG)

T1

RECTANGULAR

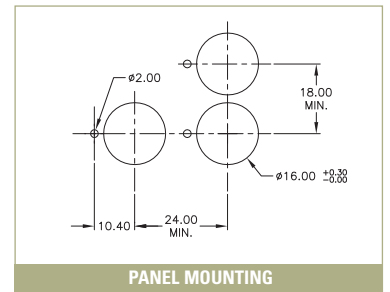
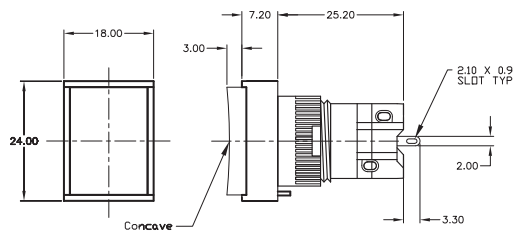

PANEL MOUNTING

#### BOTTOM VIEW

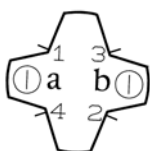

#### SCHEMATIC

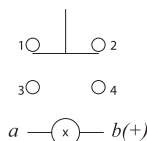

#### MOUNTING LENGTH

	Mounting Length (A)
SPDT	29.0 mm
DPDT	36.5 mm
3PDT	44.0 mm
4PDT	51.5 mm

# SERIES P16 SWITCHES

## PUSHBUTTON SWITCHES - ILLUMINATED

TACT SWITCHES

NAVIGATION SWITCHES

PUSHBUTTON SWITCHES

TOGGLE SWITCHES

ROCKER SWITCHES

SLIDE SWITCHES

SNAP-ACTION SWITCHES

DIP SWITCHES

KEYLOCK SWITCHES

ROTARY SWITCHES

DETECTOR SWITCHES

CAP OPTIONS

### P16 (SOCKET)

R

MUSHROOM



PANEL MOUNTING

### P16 (SOCKET)

R1

ROUND



PANEL MOUNTING

### P16 (SOCKET)

S1

SQUARE



PANEL MOUNTING

### P16 (SOCKET)

T1

RECTANGULAR



PANEL MOUNTING

BOTTOM VIEW



SCHEMATIC





# SERIES L16 SWITCHES

## PUSHBUTTON SWITCHES - ILLUMINATED

### L16 (PILOT INDICATOR)

R1

ROUND

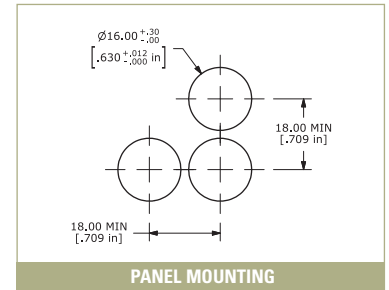
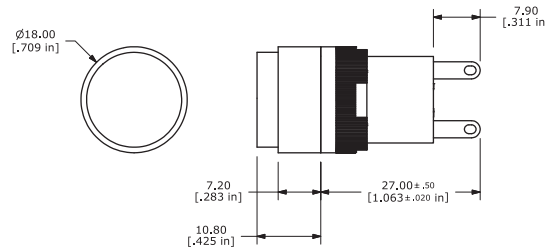

PANEL MOUNTING

### L16 (PILOT INDICATOR)

S1

SQUARE

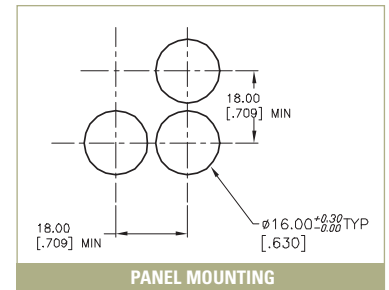

PANEL MOUNTING

### L16 (PILOT INDICATOR)

T1

RECTANGULAR

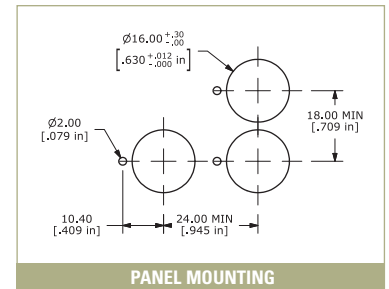

PANEL MOUNTING

#### BOTTOM VIEW



#### SCHEMATIC



# SERIES D16, P16, L16 SWITCHES

## PUSHBUTTON SWITCHES - ILLUMINATED

TACT SWITCHES

NAVIGATION SWITCHES

PUSHBUTTON SWITCHES

TOGGLE SWITCHES

ROCKER SWITCHES

SLIDE SWITCHES

SNAP-ACTION SWITCHES

DIP SWITCHES

KEYLOCK SWITCHES

ROTARY SWITCHES

DETECTOR SWITCHES

CAP OPTIONS

### MECHANICAL CONFIGURATION & CIRCUIT OPTIONS

#### 0 PILOT INDICATOR

Available 'L16' Pilot Indicator Type



SCHEMATIC

#### 1 SPDT\*\*

Available for 'P16' Socket Type and 'D16' Solder Lug



SCHEMATIC

#### 2 DPDT

Available for 'D16' Solder Lug



SCHEMATIC

#### 3 3PDT

Available for 'D16' Solder Lug



SCHEMATIC

#### 4 4PDT

Available for 'D16' Solder Lug



SCHEMATIC

#### Mechanical Configuration Code

EE	Latching
OA	Momentary
PL	Pilot Indicator*

\*L16' Series only

### LAMP TYPE & VOLTAGE OPTIONS

ILLUSTRATION	CATEGORY	DESCRIPTION	COLOR	PART NO.
	Incandescent	A = 6V AC/DC 200 mA	Not Applicable	50-004-02
		B = 14V AC/DC 80 mA		50-004-04
		C = 28V AC/DC 40 mA		50-004-05
		D = 48V AC/DC 25 mA		50-004-06
		E = 60V AC/DC 20 mA		50-004-07
		L = 33V AC/DC 35 mA		50-004-08
		N = 14V AC/DC 40 mA		50-004-03
		M = 6V AC/DC 40 mA		50-004-01
	Neon	F = 110V AC	green red	50-004-11 50-004-12
		G = 220V AC	green red	50-004-13 50-004-14
		H = 6V DC	green red yellow	50-004-16 50-004-17 50-004-18
			J = 12V DC	green red yellow
K = 24V DC	green red yellow			50-004-22 50-004-23 50-004-24



ILLUSTRATION		STYLE	SHAPE	COLOR	PART NO.
	Available Color Lens (Acrylic Resin)	Round	Concave	blue green orange red white yellow	50-001-01 50-001-02 50-001-03 50-001-04 50-001-05 50-001-06
		Rectangular	Concave	blue green orange red white yellow	50-002-01 50-002-02 50-002-03 50-002-04 50-002-05 50-002-06
		Square	Concave	blue green orange red white yellow	50-003-01 50-003-02 50-003-03 50-003-04 50-003-05 50-003-06
		Mushroom Head	Convex	green red	50-012-01 50-012-02
		Round	Flat	blue green orange red white yellow	50-001-11 50-001-12 50-001-13 50-001-14 50-001-15 50-001-16
		Rectangular	Flat	blue green orange red white yellow	50-002-11 50-002-12 50-002-13 50-002-14 50-002-15 50-002-16
		Square	Flat	blue green orange red white yellow	50-003-11 50-003-12 50-003-13 50-003-14 50-003-15 50-003-16

TACT  
SWITCHES

NAVIGATION  
SWITCHES

PUSHBUTTON  
SWITCHES

TOGGLE  
SWITCHES

ROCKER  
SWITCHES

SLIDE  
SWITCHES

SNAP-ACTION  
SWITCHES

DIP  
SWITCHES

KEYLOCK  
SWITCHES

ROTARY  
SWITCHES

DETECTOR  
SWITCHES

CAP  
OPTIONS

# SERIES D16, P16, L16 SWITCHES

## PUSHBUTTON SWITCHES - ILLUMINATED

TACT SWITCHES

NAVIGATION SWITCHES

PUSHBUTTON SWITCHES

TOGGLE SWITCHES

ROCKER SWITCHES

SLIDE SWITCHES

SNAP-ACTION SWITCHES

DIP SWITCHES

KEYLOCK SWITCHES

ROTARY SWITCHES

DETECTOR SWITCHES

CAP OPTIONS

ILLUSTRATION	CATEGORY	DESCRIPTION	PART NO.
	Lamp Extractor * Also available for LA Series	Lamp removing tool	50-005-01
	Blanking Plate Block	PVC stopper to stuff the superfluous hole of the panel board	50-013-01
	Connector * Also available for LA Series	Insulation Socket 2.8 x 0.5 mm	50-014-01
	PCB Mounting Socket		50-015-01
	Mounting Wrench * Also available for LA Series	Use this for tightening the switch in the mounting hole	50-006-01
	Lens Removing Tool	Use this for replacing the fitted color lens	50-007-01
	Spray Cover	Meets requirement of IP65, two pieces of transparent plastic, rectangular head	50-010-01
	Protection Cap	To avoid faulty operation, housing for locking, transparent For square head (90°) For square head (180°) For rectangular head (90°) For rectangular head (180°)	50-011-01 50-011-11 50-011-02 50-011-12