



SERIES LA SWITCHES

PUSHBUTTON SWITCHES - SEALED ILLUMINATED



SPECIFICATIONS

Contact Rating:	5A @ 250 VAC 8A @ 125 VAC 2A @ 250 VDC 6A @ 24 VDC
Life Expectancy (Mechanical):	≥ 100,000 cycles
Life Expectancy (Electrical):	≥ 50,000 cycles
Contact Resistance:	100mΩ max. typical; initial @ 2-4 VDC
Insulation Resistance:	> 1,000MΩ
Dielectric Strength:	> 1,500 volts 1 minute > 3,000 volts between poles
Actuation Force:	300g / pole
Operating Temperature:	-20°C to 55°C
Degree of Protection:	IP65

FEATURES & BENEFITS

- ▶ Modular interface/contact block design
- ▶ Robust product for industrial applications
- ▶ Attractive front panel design
- ▶ Illuminated options available

APPLICATIONS/MARKETS

- ▶ Industrial controls
- ▶ Instrumentation
- ▶ Transportation
- ▶ Telecommunications

MATERIALS

Switch Housing:	Polyetherimide (PEI)
Contact Housing:	Diallyl Phthalate (DAP)
Actuator Ring:	Polycarbonate (PC)
Lens:	Polycarbonate (PC)
Contacts:	Silver plated copper alloy
Terminals:	Silver plated copper alloy



HOW TO ORDER

SERIES LA	TERMINATION	MECHANICAL CONFIGURATION	PUSHBUTTON HEAD	CIRCUIT	LAMP TYPE & VOLTAGE	LAMP COLOR (WHERE APPLICABLE)	LENS COLOR
	S = Solder Lug K = Socket P = Pilot Indicator	EE = Latching OA = Momentary PL* = Pilot Indicator *For LAP (Pilot Indicator)	U1 = Ø29mm V1 = Ø25mm U3* = Ø29mm V3* = Ø25mm *Flush Mount	0* = Pilot Ind. 1** = SPDT 2 = DPDT 3 = 3PDT 4 = 4PDT *For LAP (Pilot Indicator only) **LAK available SPDT only	0 = None A B C F G H J K M N L D E	Red Grn Red Grn Yel	RED = Red GRN = Green BLU = Blue WHT = White ORG = Orange YEL = Yellow



Example Ordering Number

LA-S-EE-U1-1-0-RED

Specifications subject to change without notice.

LAMP TYPE & VOLTAGE OPTIONS

0	:	Without lamp
A	:	Incandescent 6 V AC/DC 200 mA
B	:	Incandescent 14 V AC/DC 80 mA
C	:	Incandescent 28 V AC/DC 40 mA
D	:	Incandescent 48 V AC/DC 25 mA
E	:	Incandescent 60 V AC/DC 20 mA
F	:	Neon 110 V AC green/red
G	:	Neon 220 V AC green/red

LAMP TYPE & VOLTAGE OPTIONS

H	:	LED 6 V DC green/yellow/red
J	:	LED 12 V DC green/yellow/red
K	:	LED 24 V DC green/yellow/red
L	:	Incandescent 33 V AC/DC 35 mA
N	:	Incandescent 14 V AC/DC 40 mA
M	:	Incandescent 6 V AC/DC 40 mA

SERIES LA SWITCHES

PUSHBUTTON SWITCHES - SEALED ILLUMINATED

TERMINATION & PUSHBUTTON HEAD OPTIONS

LAS

SOLDER LUG

U1 Ø29mm

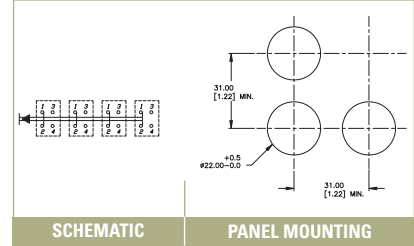
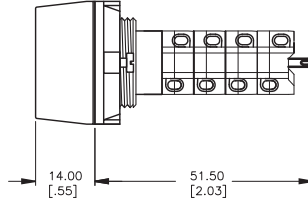
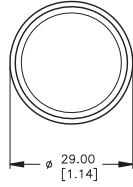

SCHEMATIC

PANEL MOUNTING

V1 Ø25mm

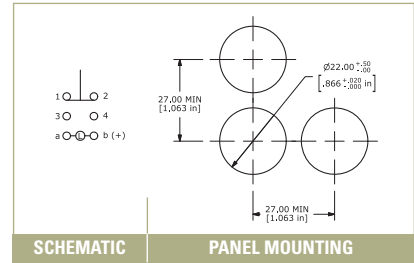
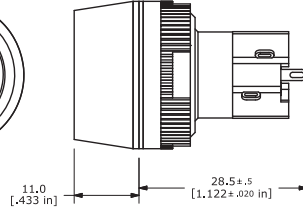
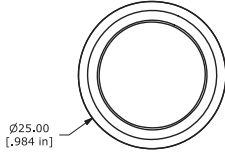

SCHEMATIC

PANEL MOUNTING

U3

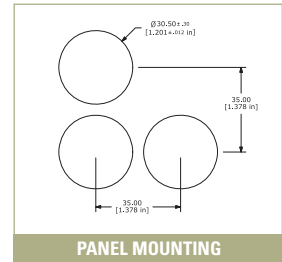
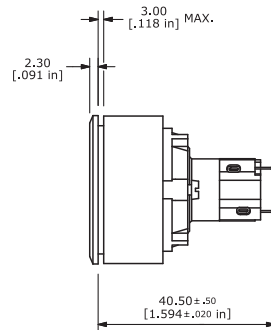
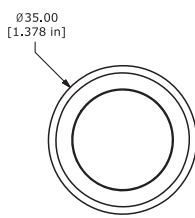

PANEL MOUNTING

V3

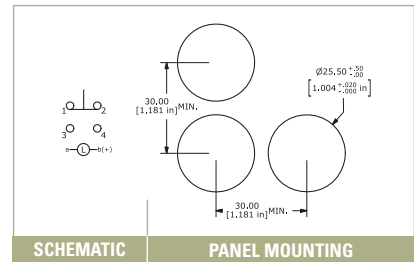
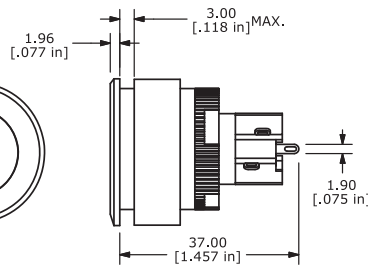
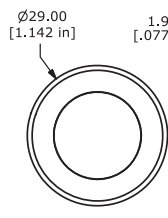

SCHEMATIC

PANEL MOUNTING

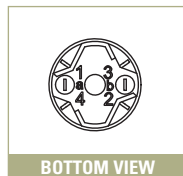

BOTTOM VIEW

	Mounting Length (A)
SPDT	29.0 mm
DPDT	36.5 mm
3PDT	44.0 mm
4PDT	51.5 mm

TERMINATION & PUSHBUTTON HEAD OPTIONS

LAK

SOCKET

U1 Ø29mm

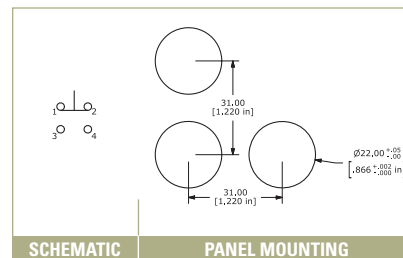
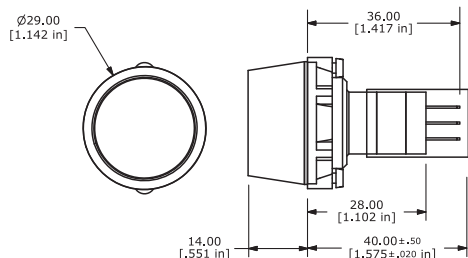

V1 Ø25mm

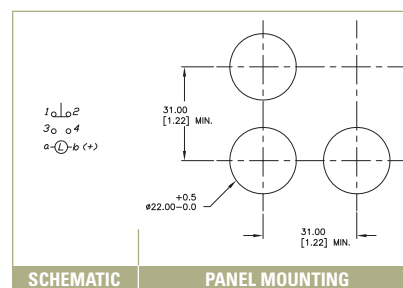
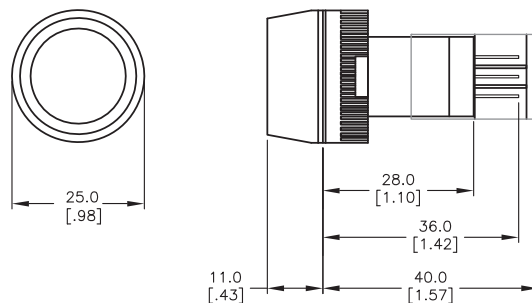

U3

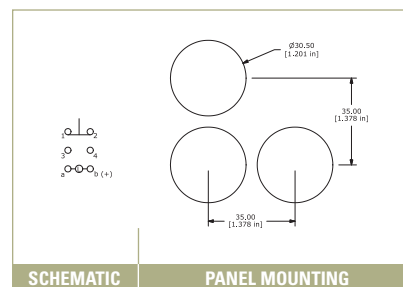
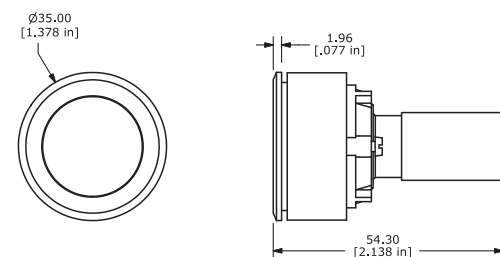

V3

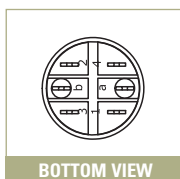
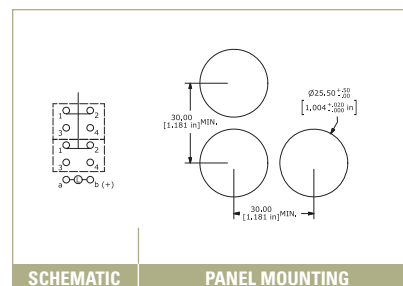
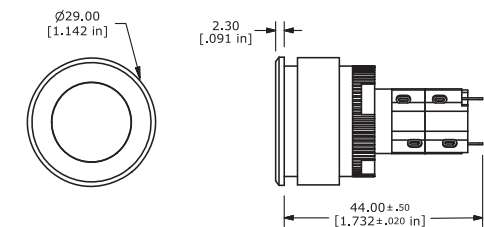

TACT SWITCHES

NAVIGATION SWITCHES

PUSHBUTTON SWITCHES

TOGGLE SWITCHES

ROCKER SWITCHES

SLIDE SWITCHES

SNAP-ACTION SWITCHES

DIP SWITCHES

KEYLOCK SWITCHES

ROTARY SWITCHES

DETECTOR SWITCHES

CAP OPTIONS

SERIES LA SWITCHES

PUSHBUTTON SWITCHES - SEALED ILLUMINATED

TERMINATION & PUSHBUTTON HEAD OPTIONS

LAP

PILOT INDICATOR

U1 Ø29mm

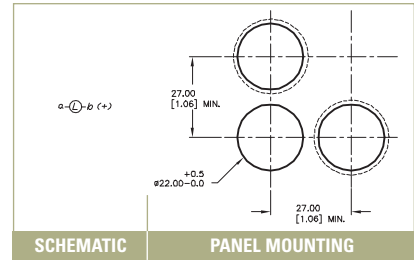
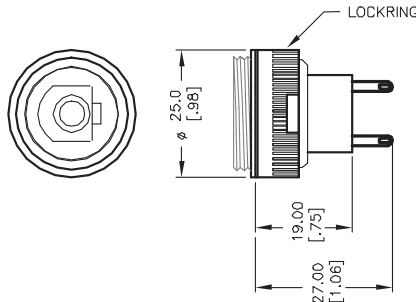

V1 Ø25mm

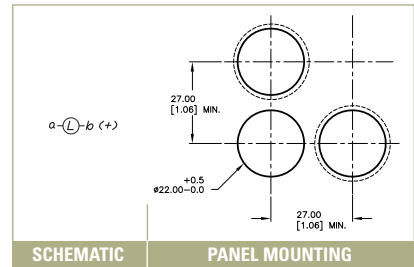
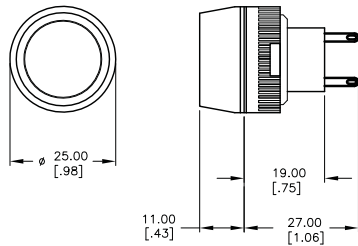

U3

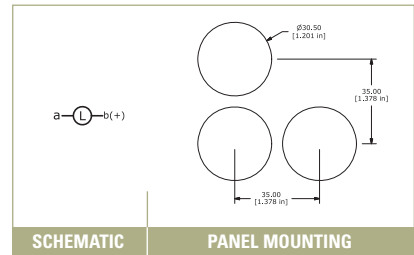
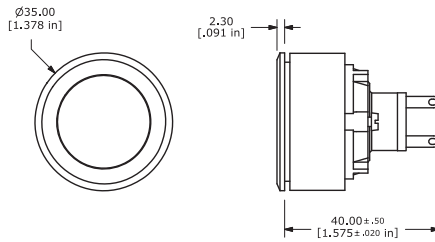

V3

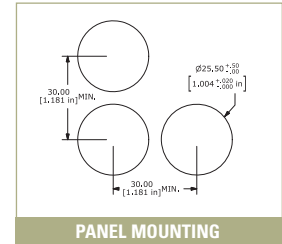
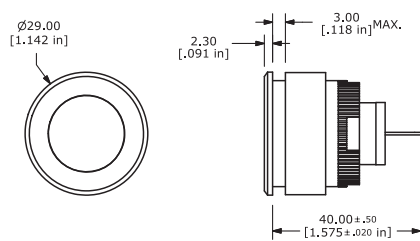

MECHANICAL CONFIGURATION & CIRCUIT OPTIONS

0 PILOT INDICATOR

Available LAS Pilot Indicator



SCHEMATIC

1 SPDT

Available for LAK Socket Type and LAS Solder Lug

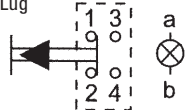

SCHEMATIC

2 DPDT

Available for LAS Solder Lug

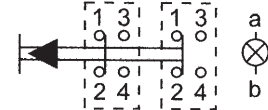

SCHEMATIC

3 3PDT

Available for LAS Solder Lug

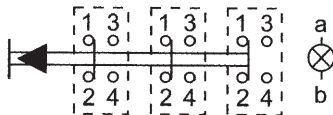

SCHEMATIC

4 4PDT

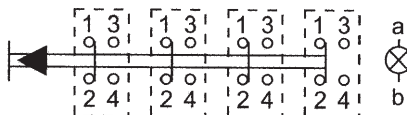

SCHEMATIC

Mechanical Configuration Code

EE	Latching
OA	Momentary
PL	Pilot Indicator