

ANTI-VANDAL SWITCHES  
 DETECTOR SWITCHES  
 DIP SWITCHES  
 KEYLOCK SWITCHES  
 NAVIGATION SWITCHES  
 PUSHBUTTON SWITCHES  
 ROCKER SWITCHES  
 ROTARY SWITCHES  
 SLIDE SWITCHES  
 SNAP ACTION SWITCHES  
 TACTILE SWITCHES  
 TOGGLE SWITCHES  
 CAP OPTIONS

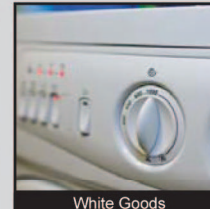

## APPLICATIONS / MARKETS

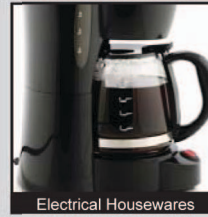
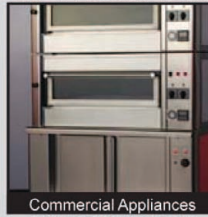

RoHS

## SPECIFICATIONS

**Electrical Rating:** 16(16)A 125VAC 5E4 T85 [cURus]  
 1/3HP 125VAC IP66 [cURus]  
 10(10)A 250VAC 5E4 T85 [VDE]

**Electrical Life:** 50,000 Cycles

**Mechanical Life:** 50,000 Cycles

**Contact Resistance:** <30mΩ Max.

**Insulation Resistance:** 500MΩ Min. at 500VDC

**Dielectric Strength:** 1000VAC for 1 Minute

**Operating Temperature:** -20°C to 85°C Min.

**Ingress Protection:** IP66

**Panel Cutout:** 22mm x 30mm

**Function:** DPST, Off-On  
 DPDT, On-On

## FEATURES & BENEFITS

- Full illumination options available
- Approved under new UL 61058-1 rating
- UL approved up to 1/3HP
- Internally sealed to an IP66 rating using patented technology (Patent No.: US 7,872,205 B2)

## PART NUMBER CONFIGURATOR

Series	Circuit	Body Color	Actuator Color	Marking	Termination	Lamp Voltage
RBW2	A - Off-On (DPST) *B - On-On (DPDT)	BLK - Black WHT - White	BLK - Black WHT - White RED - Red RIL - Red Full Illum. GIL - Green Full Illum. YIL - Yellow Full Illum. BIL - Blue Full Illum.	A - Dot D - I/II Vertical F - I/O Vertical G - I/O Horizontal I - On/Off Vertical E - No Marking	F - 6.3mm Tab	0 - No Lamp 1 - 125VAC Neon 2 - 250VAC Neon 3 - 12VDC Incandescent

\* Not available with illumination

Specifications subject to change without notice



## BODY DIMENSIONS

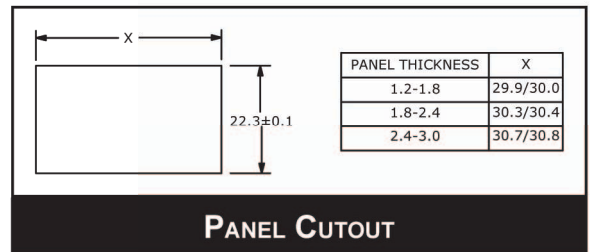
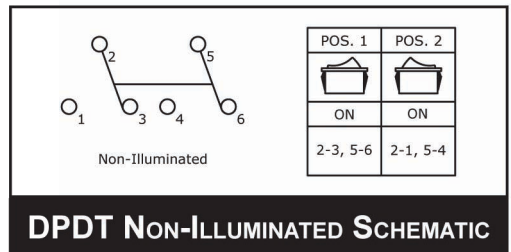
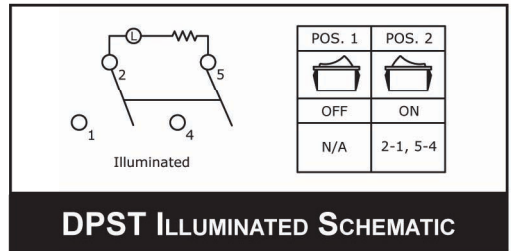
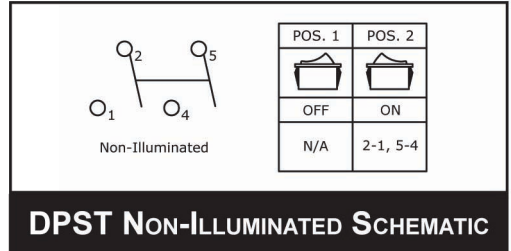
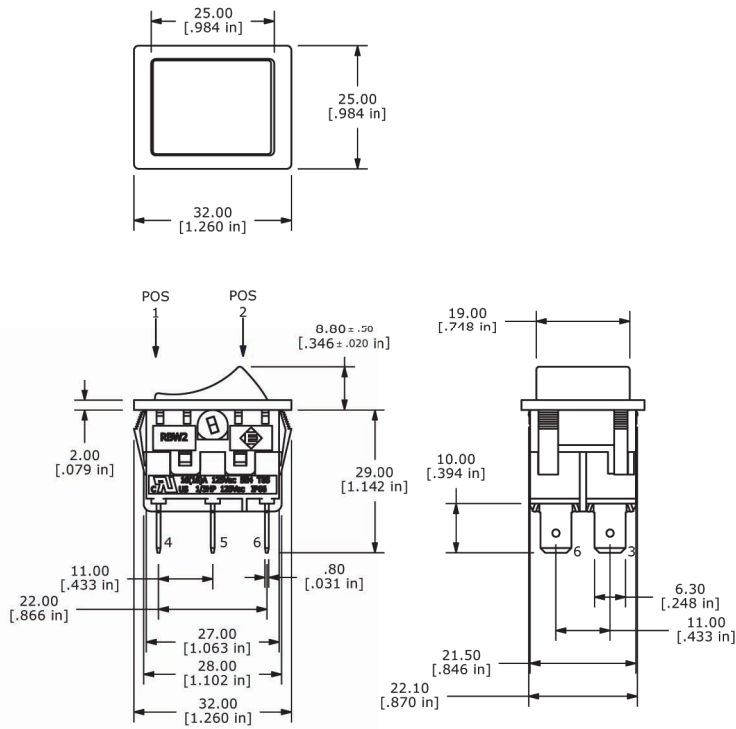

## MARKINGS

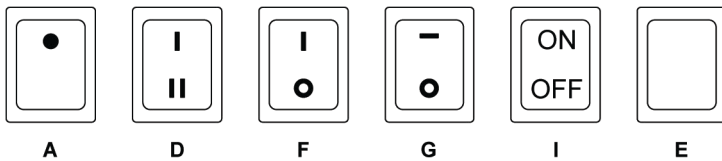

ANTI-VANDAL SWITCHES  
 DETECTOR SWITCHES  
 DIP SWITCHES  
 KEYLOCK SWITCHES  
 NAVIGATION SWITCHES  
 PUSHBUTTON SWITCHES  
 ROCKER SWITCHES  
 ROTARY SWITCHES  
 SLIDE SWITCHES  
 SNAP ACTION SWITCHES  
 TACTILE SWITCHES  
 TOGGLE SWITCHES  
 CAP OPTIONS

