



SERIES 307/357



FEATURES

UL Recognized
 .156 (3.96) Contact Spacing x .200 (5.08) Row Spacing
 Accepts .062 (1.57) Nominal Thickness P.C. Board
 Low Profile Insulator Body .437 (12.01)

Contact Termination Options include P.C Tail, Wire Hole, Wire Wrap, 90 Degree & Extender Board Bends
 Single or Dual Row Configurations

Large Variety of Mounting Options
 Pre-assembled Card Guides Available
 Accepts Between Contact & In-Contact Polarizing Keys

SPECIFICATIONS

Insulator Material: Thermoplastic Polyester, UL 94V-0.
 Contact Material: Copper, Nickel, Tin Alloy CA-725
 Contact Plating: Gold on the Mating Area, Tin on the Contact Tails, Nickel Underplate

Current Rating: 5 Amperes Continuous
 Contact Resistance: 10 Milliohms Maximum
 Dielectric Withstanding Voltage: 1800 V AC rms at Sea Level Between Adjacent Contacts
 Insulation Resistance: 5000 Megohms Minimum
 Operating Temperature: -65 to +105 Degrees C
 Insertion Force: 16 oz (4.45 N) Maximum per Contact Pair when Tested with a .070 (1.78) Thick Gauge
 Withdrawal Force: 1 oz (.28 N) Minimum per Contact Pair when Tested with a .054 (1.37) Thick Gauge

Ordering Code Notes

- All connector sizes up to 44 contacts single row / 88 contacts dual row are available upon request
- For contacts with overall tin plating, change the first digit of the contact code from 5 to 4
- Single row contacts that read both sides of the daughter board are phosphor bronze CA-510 material with entire surface plated gold over nickel

Example Part Number 307 - 044 - 520 - 2 02

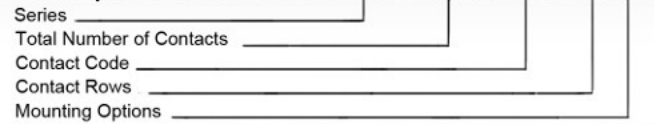

Series	Insulator Colour
307	Green
357	Black

Total Number of Contacts	Contact Rows
005, 006, ..., 044	
012, 014, ..., 188	Dual Row

Contact Code	Description & Tail Size	Tail Length "G"
<i>Single Row Contacts - Read One Side of Daughter Board</i>		
505	Wire Hole .087 x .013 (2.21 x 0.33)	.282 (7.16)
525	P.C. Tail .046 x .013 (1.17 x 0.33)	.213 (5.41)
527	P.C. Tail .046 x .013 (1.17 x 0.33)	.358 (9.09)
531	P.C. Tail .023 x .013 (0.58 x 0.33)	.213 (5.41)
545	Wire Wrap .046 x .013 (1.17 x 0.33)	.708(17.98)
547	Wire Wrap .046 x .013 (1.17 x 0.33)	.520(13.21)
558	90 Degree Bend (Code 545 Contacts)	
559	90 Degree Bend (Code 527 Contacts)	
<i>Single Row Contacts - Read Both Sides of Daughter Board</i>		
501	Wire Hole .089 x .014 (2.29 x 0.36)	.213 (5.41)
521	P.C. Tail .046 x .014 (1.17 x 0.36)	.213 (5.41)
541	Wire Wrap .046 x .014 (1.17 x 0.36)	.495(12.57)
553	90 Degree Bend (Code 521 Contacts)	
554	90 Degree Bend (Code 501 Contacts)	
557	90 Degree Bend (Code 541 Contacts)	
<i>Dual Row Contacts - Read Both Sides of Daughter Board</i>		
500	Wire Hole .087 x .013 (2.21 x 0.33)	.282 (7.16)
520	P.C. Tail .046 x .013 (1.17 x 0.33)	.213 (5.41)
522	P.C. Tail .046 x .013 (1.17 x 0.33)	.358 (9.09)
524	P.C. Tail .023 x .013 (0.58 x 0.33)	.213 (5.41)
540	Wire Wrap .046 x .013 (1.17 x 0.33)	.708(17.98)
542	Wire Wrap .046 x .013 (1.17 x 0.33)	.520(13.21)
555	Extender Board Bend (Code 500 Contacts)	
556	Extender Board Bend (Code 520 Contacts)	
558	90 Degree Bend (Code 522 and 540 Contacts)	
559	90 Degree Bend (Code 522 and 540 Contacts)	
560	Extender Board Bend (Code 522 Contacts)	

Contact Rows	Description
1	Single Row
2	Dual Row

Mounting Options	Description
01	No Mounting Lugs
02	.128 (3.25) Dia. Mounting Holes
03	.116 (2.95) I.D. Floating Eyelets
04	.156 (3.96) Dia. Mounting Holes
07	M3-0.5 Metric Threaded Inserts
08	#4-40 Unified Threaded Inserts
12	.128 (3.25) Dia. Side Mounting Holes
58	.468 (11.89) Offset Card Guides
68	.344 (8.74) Offset Card Guides
78	In-Line Card Guides

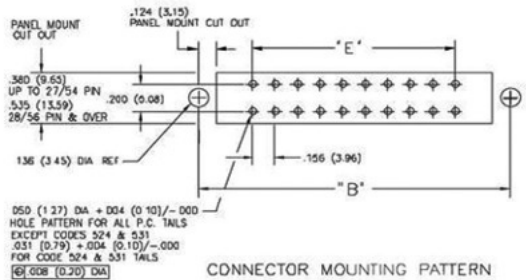
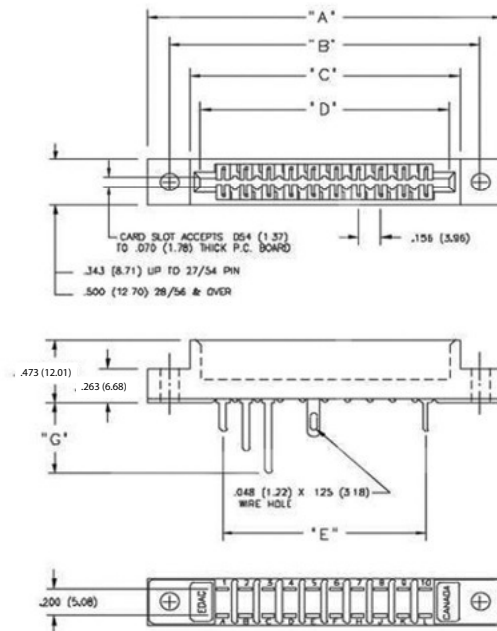

IN-CONTACT POLARIZING KEY

P/N 307-240-328



DUAL ROW CONTACTS

BETWEEN CONTACT POLARIZING KEY

P/N 306-240-318



SINGLE ROW CONTACTS

READ ONE SIDE OF DAUGHTER BOARD

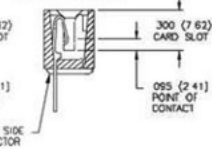
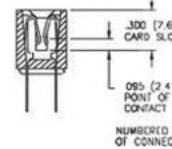

SINGLE ROW CONTACTS

READ BOTH SIDES OF DAUGHTER BOARD

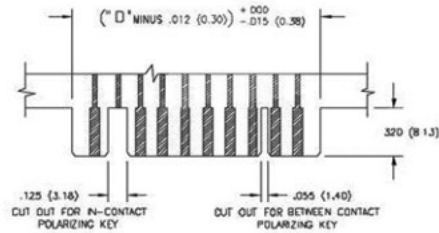
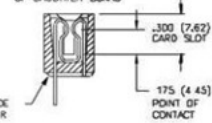

CONNECTOR MOUNTING PATTERN

RECOMMENDED DAUGHTER BOARD

NUMBER OF CONTACTS	"A"		"B"		"C"		"D"		"E"		
	Single	Dual	Inch	(mm)	Inch	(mm)	Inch	(mm)	Inch	(mm)	
6	12	1.842	(46.79)	1.532	(38.91)	1.246	(31.65)	1.100	(27.94)	.780	(19.81)
8	16	2.154	(54.71)	1.844	(46.84)	1.558	(39.57)	1.412	(35.86)	1.002	(27.74)
10	20	2.466	(62.64)	2.156	(54.76)	1.870	(47.50)	1.724	(43.79)	1.404	(35.66)
12	24	2.778	(70.56)	2.468	(62.69)	2.182	(55.42)	2.036	(51.71)	1.716	(43.59)
15	30	3.246	(82.45)	2.936	(74.57)	2.650	(67.31)	2.504	(63.60)	2.184	(55.47)
18	36	3.714	(94.34)	3.404	(86.46)	3.118	(79.20)	2.972	(75.49)	2.652	(67.36)
20	40	4.026	(102.26)	3.716	(94.39)	3.430	(87.12)	3.284	(83.41)	2.964	(75.29)
22	44	4.338	(110.19)	4.028	(102.31)	3.742	(95.05)	3.596	(91.34)	3.276	(83.21)
25	50	4.806	(122.07)	4.496	(114.20)	4.210	(106.93)	4.064	(103.23)	3.744	(95.10)
28	56	5.274	(133.96)	4.964	(126.09)	4.678	(118.82)	4.532	(115.11)	4.212	(106.98)
30	60	5.586	(141.88)	5.276	(134.01)	4.990	(126.75)	4.844	(123.04)	4.524	(114.91)
36	72	6.522	(166.66)	6.212	(157.78)	5.926	(150.52)	5.780	(146.81)	5.460	(138.68)
43	86	7.614	(193.40)	7.304	(185.52)	7.018	(178.26)	6.872	(174.55)	6.552	(166.42)
44	88	7.770	(197.36)	7.460	(189.48)	7.174	(182.22)	7.028	(178.51)	6.708	(170.38)

Dimensions of Other Connector Sizes are Listed