

## Ceramic transient voltage suppressors

### SMD multilayer transient voltage suppressors for automotive applications

The following products presented in this data sheet are being withdrawn.

Ordering Code	Substitute Product	Date of Withdrawal	Deadline Last Orders	Last Shipments
B72510T5250K062		2012-11-09	2013-03-01	2013-06-01

For further information please contact your nearest EPCOS sales office, which will also support you in selecting a suitable substitute. The addresses of our worldwide sales network are presented at [www.epcos.com/sales](http://www.epcos.com/sales).

© EPCOS AG 2015. Reproduction, publication and dissemination of this publication, enclosures hereto and the information contained therein without EPCOS' prior express consent is prohibited.

EPCOS AG is a TDK Group Company.

## Multilayer varistors (MLVs)

### Automotive series

#### SMD

#### EPCOS type designation system for automotive series

CN	2220	S	14	B	AUTO	E2	G2	K2
<p><b>Construction:</b>            CT <math>\triangle</math> Single chip with nickel barrier termination (AgNiSn)            CN <math>\triangle</math> Single chip with silver-palladium termination (AgPd)            CN...K2 <math>\triangle</math> Single chip with silver-platinum termination (AgPt)</p>								
<p><b>EAI case sizes:</b>            0603            0805            1206            1210            1812            2220</p>								
<p><b>Varistor voltage tolerance:</b>            K <math>\triangle</math> <math>\pm 10\%</math>, standard            S <math>\triangle</math> Special tolerance</p>								
<p><b>Maximum RMS operating voltage (<math>V_{RMS}</math>):</b>            14 <math>\triangle</math> 14 V  <math>V_{RMS} &lt; 25</math> V are suitable for 12 V DC supply systems  <math>V_{RMS} \geq 25</math> V are suitable for 24 V DC supply systems</p>								
<p><b>Special tolerance for the varistor voltage:</b>            – <math>\triangle</math> Standard tolerance            B <math>\triangle</math> Special tolerance</p>								
<p><b>Automotive series</b></p>								
<p><b>Special features:</b>            – <math>\triangle</math> Standard energy handling capability            E2 <math>\triangle</math> Increased energy handling capability            HT <math>\triangle</math> High temperature version            LC <math>\triangle</math> Low capacitance version            CC <math>\triangle</math> Controlled capacitance version</p>								
<p><b>Taping mode:</b>            G <math>\triangle</math> Taped, 180-mm reel, 7"            G2 <math>\triangle</math> Taped, 330-mm reel, 13"</p>								
<p>AgPt termination</p>								

## Multilayer varistors (MLVs)

### Automotive series

#### SMD

#### Features

- ESD protection up to 25 kV, ISO 10605 level IV, acc. to IEC 61000-4-2 level 4 (8 kV contact, 15 kV air)
- High energy absorption capability
- Low leakage current
- High temperature versions
- Stable protection level
- Bidirectional clamping
- No temperature derating up to 125 °C
- RoHS-compatible
- Nickel barrier and AgPt series suitable for lead-free soldering
- Nickel barrier and AgPt series qualified based on AEC-Q200 rev. C
- PSpice simulation models available

#### Applications

- Transient overvoltage protection in automotive applications: engine management, airbag, control units, electrohydraulic brake, ABS/ESP, sunroof
- Load dump protection
- Jump start protection

#### Design

- Multilayer technology
- Lack of plastic or epoxy encapsulation for flammability rating better than UL 94 V-0
- Termination (see “Soldering directions”):
  - CT types with nickel barrier terminations (AgNiSn), recommended for lead-free reflow and wave soldering, and compatible with tin/lead solder.
  - CN types with silver-palladium terminations (AgPd) only suitable for reflow and wave soldering with solder on tin/lead basis and for adhesive glueing.
  - CN...K2 types with silver-platinum terminations (AgPt) suitable for reflow lead-free soldering.

#### V/I characteristics and derating curves

V/I and derating curves are attached to the data sheet. The curves are sorted by  $V_{RMS}$  and then by case size, which is included in the type designation.

#### Single chip

##### Internal circuit

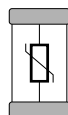

MLV0006-H

##### Available case sizes:

EIA	Metric
0603	1608
0805	2012
1206	3216
1210	3225
1812	4532
2220	5750

**Multilayer varistors (MLVs)**
**Automotive series**
**SMD**
**General technical data**

Maximum RMS operating voltage		$V_{RMS,max}$	14 ... 30	V
Maximum DC operating voltage		$V_{DC,max}$	16 ... 38	V
Maximum surge current	(8/20 $\mu$ s)	$I_{surge,max}$	5 ... 1200	A
Maximum load dump energy	(10 pulses)	$W_{LD}$	1 ... 25	J
Maximum jump start voltage	(5 min)	$V_{jump}$	24.5 ... 45	V
Maximum clamping voltage	(8/20 $\mu$ s)	$V_{clamp,max}$	40 ... 120	V
Operating temperature	AUTO types	$T_{op}$	-55/+125	°C
Operating temperature	HT types	$T_{op}$	-55/+150	°C
Operating temperature	special capacitance types	$T_{op}$	-55/+125	°C
Operating temperature	standard types	$T_{op}$	-55/+125	°C
Storage temperature	all types	LCT/UCT	-55/+150	°C

## Multilayer varistors (MLVs)

### Automotive series

#### SMD

#### Temperature derating

Climatic category:  $-55/+125\text{ }^{\circ}\text{C}$

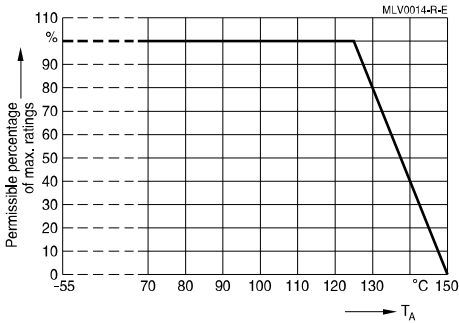

For automotive, special capacitance and standard range.

Climatic category:  $-55/+150\text{ }^{\circ}\text{C}$

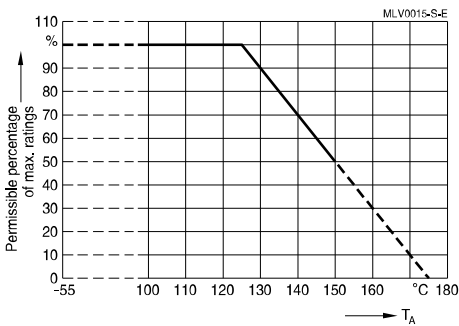

For high temperature (HT) range.

**Multilayer varistors (MLVs)**
**Automotive series**
**SMD**
**Electrical specifications and ordering codes**
**Maximum ratings ( $T_{op,max} = 125\text{ }^{\circ}\text{C}$ , for HT types  $T_{op,max} = 150\text{ }^{\circ}\text{C}$ )**

Type	Ordering code	$V_{RMS,max}$	$V_{DC,max}$	$I_{surge,max}$ (8/20 $\mu\text{s}$ )	$W_{max}$ (2 ms)	$W_{LD}$ (10 pulses)	$P_{diss,max}$
		V	V	A	mJ	J	mW
<b>AUTO range, CN types</b>							
CN1812S14BAUTOE2G2	B72580V3140S272	14	16	800	2400	12	15
CN1812S14BAUTOE2G2K2	B72582V3140S272	14	16	800	2400	12	15
CN1812S14BAUTOG	B72580V1140S262	14	16	800	2400	6	15
CN1812S14BAUTOGK2	B72582V1140S262	14	16	800	2400	6	15
CN2220S14BAUTOE2G2	B72540V3140S272	14	16	1200	5800	25	30
CN2220S14BAUTOE2G2K2	B72542V3140S272	14	16	1200	5800	25	30
CN2220S14BAUTOG	B72540V1140S262	14	16	1200	5800	12	30
CN2220S14BAUTOGK2	B72542V1140S262	14	16	1200	5800	12	30
CN2220S14EAUTOE2G2K2	B72542V3140S572	14	16	1200	5800	25	30
CN2220K30AUTOE2G2	B72540V3300K072	30	34	1200	12000	25	30
CN2220K30AUTOE2G2K2	B72542V3300K072	30	34	1200	12000	25	30
CN2220K30AUTOG	B72540V1300K062	30	34	1200	12000	12	30
CN2220K30AUTOGK2	B72542V1300K062	30	34	1200	12000	12	30
<b>AUTO range, CT types</b>							
CT0603S14BAUTOG	B72500T1140S260	14	16	30	200	-	3
CT0805S14BAUTOG	B72510T1140S262	14	16	120	300	1	8
CT1206S14BAUTOG	B72520T1140S262	14	16	200	600	1.5	8
CT1210S14BAUTOG	B72530T1140S262	14	16	400	1600	3	10
CT1210K17AUTOG	B72530T1170K062	17	22	400	1700	3	10
CT1206K20AUTOG	B72520T1200K062	20	26	200	700	1.5	8
CT1210K20AUTOG	B72530T1200K062	20	26	400	1900	3	10
CT0805K25AUTOG	B72510T1250K062	25	31	80	300	1	5
CT1206K25AUTOG	B72520T1250K062	25	31	200	1000	1.5	8
CT1210K25AUTOG	B72530T1250K062	25	31	300	1700	3	10
<b>High temperature (HT) range</b>							
CN0603S14BHTG2	B72500H0140S270	14	18	30	200	-	3
CN0603S17BHTG	B72500H0170S260	17	22	30	75	-	3
CN1210K17AUTOHTG	B72530H1170K062	17	22	400	1700	3	10
CN0603K25HTG5	B72500H0250K062	25	31	30	300	-	3
<b>Special capacitance range, CT types</b>							
CT0603S14AHSG	B72500T8140S160	14	16	5	30	-	3
CT0603K17CCG	B72500T5170K060	17	22	30	200	-	3
CT0603K17LCG	B72500T2170K060	17	22	10	100	-	1
CT0603S17ALCG	B72500T2170S160	17	22	30	75	-	3
CT0603S17BCCG	B72500T5170S260	17	22	30	75	-	3

**Multilayer varistors (MLVs)**
**Automotive series**
**SMD**
**Characteristics (T<sub>A</sub> = 25 °C)**

Type	V <sub>V</sub> (1 mA)	ΔV <sub>V</sub>	V <sub>jump</sub> (5 min)	V <sub>clamp,max</sub>	I <sub>clamp</sub> (8/20 μs)	C <sub>typ</sub> (1 kHz)	C <sub>min</sub> (1 kHz)	C <sub>max</sub> (1 kHz)
	V	%	V	V	A	pF	pF	pF
<b>AUTO range, CN types</b>								
CN1812S14BAUTOE2G2	22	+23/-0	24.5	40	5	7000	-	-
CN1812S14BAUTOE2G2K2	22	+23/-0	24.5	40	5	7000	-	-
CN1812S14BAUTOG	22	+23/-0	24.5	40	5	5600	-	-
CN1812S14BAUTOGK2	22	+23/-0	24.5	40	5	5600	-	-
CN2220S14BAUTOE2G2	22	+23/-0	24.5	40	10	15000	-	-
CN2220S14BAUTOE2G2K2	22	+23/-0	24.5	40	10	15000	-	-
CN2220S14BAUTOG	22	+23/-0	24.5	40	10	9500	-	-
CN2220S14BAUTOGK2	22	+23/-0	24.5	40	10	9500	-	-
CN2220S14EAUTOE2G2K2	25	±10	24.5	40	10	15000	-	-
CN2220K30AUTOE2G2	47	±10	45	77	10	10000	-	-
CN2220K30AUTOE2G2K2	47	±10	45	77	10	10000	-	-
CN2220K30AUTOG	47	±10	45	77	10	4000	-	-
CN2220K30AUTOGK2	47	±10	45	77	10	4000	-	-
<b>AUTO range, CT types</b>								
CT0603S14BAUTOG	22	+23/-0	24.5	42	1	120	-	-
CT0805S14BAUTOG	22	+23/-0	24.5	42	1	400	-	-
CT1206S14BAUTOG	22	+23/-0	24.5	40	1	800	-	-
CT1210S14BAUTOG	22	+23/-0	24.5	40	2.5	1700	-	-
CT1210K17AUTOG	27	±10	26.5	44	2.5	1800	-	-
CT1206K20AUTOG	33	±10	27	54	1	600	-	-
CT1210K20AUTOG	33	±10	27	54	2.5	1500	-	-
CT0805K25AUTOG	39	±10	29	67	1	250	-	-
CT1206K25AUTOG	39	±10	29	65	1	550	-	-
CT1210K25AUTOG	39	±10	29	65	2.5	1200	-	-
<b>High temperature (HT) range</b>								
CN0603S14BHTG2	22	+23/-0	-	42	1	120	-	-
CN0603S17BHTG	25	+60/-0	-	50	1	-	32 <sup>1)</sup>	74 <sup>1)</sup>
CN1210K17AUTOHTG	27	±10	26.5	44	2.5	1800	-	-
CN0603K25HTG5	39	±10	-	67	1	90 <sup>1)</sup>	-	-
<b>Special capacitance range, CT types</b>								
CT0603S14AHSG	23	+44/-0	-	66	1	15 <sup>1)</sup>	-	30 <sup>1)</sup>
CT0603K17CCG	27	±10	-	46	1	-	128	192
CT0603K17LCG	27	±10	-	50	1	-	-	50 <sup>1)</sup>
CT0603S17ALCG	25	+60/-0	-	50	1	-	-	75 <sup>1)</sup>
CT0603S17BCCG	25	+60/-0	-	50	1	-	31.8 <sup>1)</sup>	74.2 <sup>1)</sup>

1) Measured @ 1 MHz, 1 V

**Multilayer varistors (MLVs)**
**Automotive series**
**SMD**
**Electrical specifications and ordering codes**
**Maximum ratings ( $T_{op,max} = 125\text{ }^{\circ}\text{C}$ , for HT types  $T_{op,max} = 150\text{ }^{\circ}\text{C}$ )**

Type	Ordering code	$V_{RMS,max}$	$V_{DC,max}$	$I_{surge,max}$ (8/20 $\mu\text{s}$ )	$W_{max}$ (2 ms)	$W_{LD}$ (10 pulses)	$P_{diss,max}$
		V	V	A	mJ	J	mW
<b>Special capacitance range, CT types</b>							
CT0805K17AUTOLCG	B72510S2170K062	17	22	30	100	-	4
CT0805K17LCG	B72510T2170K062	17	22	30	100	-	4
CT0603S20ACCG	B72500T5200S160	20	26	30	300	-	3
CT0805S20ACC2G2	B72510T9200S172	20	26	80	400	-	5
CT0603L25HSG	B72500T8250L060	25	32	5	-	-	-
CT0805K25CCG	B72510T5250K062	25	31	80	300	-	5
<b>Standard range, CN types</b>							
CN1812K14G	B72580V0140K062	14	18	800	2300	-	15
CN1812K14GK2	B72582V0140K062	14	18	800	2300	-	15
CN2220K14G	B72540V0140K062	14	18	1200	5800	-	20
CN1812K17G	B72580V0170K062	17	22	800	2700	-	15
CN2220K17G	B72540V0170K062	17	22	1200	7200	-	20
CN1812K20G	B72580V0200K062	20	26	800	3000	-	15
CN2220K20G	B72540V0200K062	20	26	1200	7800	-	20
CN2220K20GK2	B72542V0200K062	20	26	1200	7800	-	20
CN1812K25G	B72580V0250K062	25	31	800	3700	-	15
CN2220K25G	B72540V0250K062	25	31	1200	9600	-	20
CN2220K25GK2	B72542V0250K062	25	31	1200	9600	-	20
CN1812K30G	B72580V0300K062	30	38	800	4200	-	15
CN1812K30GK2	B72582V0300K062	30	38	800	4200	-	15
CN2220K30G	B72540V0300K062	30	38	1200	12000	-	20
CN2220K30GK2	B72542V0300K062	30	38	1200	12000	-	20
<b>Standard range, CT types</b>							
CT0603K14G	B72500T0140K060	14	18	30	200	-	3
CT0603S14BG	B72500T0140S160	14	18	30	200	-	3
CT0805K14G	B72510T0140K062	14	18	120	300	-	5
CT1206K14G	B72520T0140K062	14	18	200	500	-	8
CT1210K14G	B72530T0140K062	14	18	400	1500	-	10
CT0603K17G	B72500T0170K060	17	22	30	200	-	3
CT0805K17G	B72510T0170K062	17	22	120	300	-	5
CT1206K17G	B72520T0170K062	17	22	200	600	-	8
CT1210K17G	B72530T0170K062	17	22	400	1700	-	10
CT0603K20G	B72500T0200K060	20	26	30	200	-	3
CT0805K20G	B72510T0200K062	20	26	80	300	-	5



**Multilayer varistors (MLVs)**
**Automotive series**
**SMD**
**Characteristics (T<sub>A</sub> = 25 °C)**

Type	V <sub>V</sub> (1 mA)	ΔV <sub>V</sub>	V <sub>jump</sub> (5 min)	V <sub>clamp,max</sub>	I <sub>clamp</sub> (8/20 μs)	C <sub>typ</sub> (1 kHz)	C <sub>min</sub> (1 kHz)	C <sub>max</sub> (1 kHz)
	V	%	V	V	A	pF	pF	pF
<b>Special capacitance range, CT types</b>								
CT0805K17AUTOLCG	25	+32/-0	-	50	1	-	-	100 <sup>1)</sup>
CT0805K17LCG	25	+32/-0	-	50	1	-	-	100 <sup>1)</sup>
CT0603S20ACCG	30	+40/-0	-	67	1	-	64 <sup>1)</sup>	96 <sup>1)</sup>
CT0805S20ACCG2G2	29.7	+34/-0	-	64	1	-	170	270
CT0603L25HSG	51.9	+35/-0	-	120	1	10 <sup>1)</sup>	-	15 <sup>1)</sup>
CT0805K25CCG	39	±10	-	67	1	-	162.5	337.5
<b>Standard range, CN types</b>								
CN1812K14G	22	±10	-	38	5	4500	-	-
CN1812K14GK2	22	±10	-	38	5	4500	-	-
CN2220K14G	22	±10	-	38	10	10000	-	-
CN1812K17G	27	±10	-	44	5	4000	-	-
CN2220K17G	27	±10	-	44	10	9000	-	-
CN1812K20G	33	±10	-	54	5	3000	-	-
CN2220K20G	33	±10	-	54	10	7000	-	-
CN2220K20GK2	33	±10	-	54	10	7000	-	-
CN1812K25G	39	±10	-	65	5	2500	-	-
CN2220K25G	39	±10	-	65	10	5000	-	-
CN2220K25GK2	39	±10	-	65	10	5000	-	-
CN1812K30G	47	±10	-	77	5	2000	-	-
CN1812K30GK2	47	±10	-	77	5	2000	-	-
CN2220K30G	47	±10	-	77	10	4000	-	-
CN2220K30GK2	47	±10	-	77	10	4000	-	-
<b>Standard range, CT types</b>								
CT0603K14G	22	±10	-	40	1	100	-	-
CT0603S14BG	22	+23/-0	-	42	1	120	-	-
CT0805K14G	22	±10	-	40	1	350	-	-
CT1206K14G	22	±10	-	38	1	700	-	-
CT1210K14G	22	±10	-	38	2.5	2000	-	-
CT0603K17G	27	±10	-	46	1	100	-	-
CT0805K17G	27	±10	-	46	1	400	-	-
CT1206K17G	27	±10	-	44	1	650	-	-
CT1210K17G	27	±10	-	44	2.5	1800	-	-
CT0603K20G	33	±10	-	56	1	90	-	-
CT0805K20G	33	±10	-	56	1	300	-	-

**Multilayer varistors (MLVs)**
**Automotive series**
**SMD**
**Electrical specifications and ordering codes**
**Maximum ratings ( $T_{op,max} = 125\text{ °C}$ , for HT types  $T_{op,max} = 150\text{ °C}$ )**

Type	Ordering code	$V_{RMS,max}$	$V_{DC,max}$	$I_{surge,max}$ (8/20 $\mu$ s)	$W_{max}$ (2 ms)	$W_{LD}$ (10 pulses)	$P_{diss,max}$
		V	V	A	mJ	J	mW
<b>Standard range, CT types</b>							
CT1206K20G	B72520T0200K062	20	26	200	700	-	8
CT1210K20G	B72530T0200K062	20	26	400	1900	-	10
CT0603K25G	B72500T0250K060	25	31	30	300	-	3
CT0805K25G	B72510T0250K062	25	31	80	300	-	5
CT1206K25G	B72520T0250K062	25	31	200	1000	-	8
CT1210K25G	B72530T0250K062	25	31	300	1700	-	10
CT0805K30G	B72510T0300K062	30	38	80	300	-	5
CT1206K30G	B72520T0300K062	30	38	200	1100	-	8
CT1210K30G	B72530T0300K062	30	38	300	2000	-	10

**Characteristics ( $T_A = 25\text{ °C}$ )**

Type	$V_V$ (1 mA)	$\Delta V_V$	$V_{jump}$ (5 min)	$V_{clamp,max}$	$I_{clamp}$ (8/20 $\mu$ s)	$C_{typ}$ (1 kHz)	$C_{min}$ (1 kHz)	$C_{max}$ (1 kHz)
	V	%	V	V	A	pF	pF	pF
<b>Standard range, CT types</b>								
CT1206K20G	33	$\pm 10$	-	54	1	600	-	-
CT1210K20G	33	$\pm 10$	-	54	2.5	1500	-	-
CT0603K25G	39	$\pm 10$	-	67	1	90	-	-
CT0805K25G	39	$\pm 10$	-	67	1	250	-	-
CT1206K25G	39	$\pm 10$	-	65	1	550	-	-
CT1210K25G	39	$\pm 10$	-	65	2.5	1200	-	-
CT0805K30G	47	$\pm 10$	-	77	1	200	-	-
CT1206K30G	47	$\pm 10$	-	77	1	500	-	-
CT1210K30G	47	$\pm 10$	-	77	2.5	1000	-	-

## Multilayer varistors (MLVs)

### Automotive series

### SMD

#### Dimensional drawing

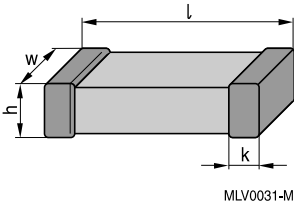

#### Dimensions in mm

Case size EIA / mm	l	w	h	k
0603 / 1608	1.6 ±0.15	0.80 ±0.10	0.9 max.	0.10 ... 0.40
0805 / 2012	2.0 ±0.20	1.25 ±0.15	1.4 max.	0.13 ... 0.75
1206 / 3216	3.2 ±0.30	1.60 ±0.20	1.7 max.	0.25 ... 0.75
1210 / 3225	3.2 ±0.30	2.50 ±0.25	1.7 max.	0.25 ... 0.75
1812 / 4532	4.5 ±0.40	3.20 ±0.30	2.5 max.	0.25 ... 1.00
2220 / 5750	5.7 ±0.40	5.00 ±0.40	2.5 max.	0.25 ... 1.00

#### Recommended solder pad layout

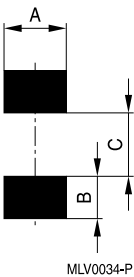

#### Dimensions in mm

Case size EIA / mm	A	B	C
0603 / 1608	1.00	1.00	1.00
0805 / 2012	1.40	1.20	1.00
1206 / 3216	1.80	1.20	2.10
1210 / 3225	2.80	1.20	2.10
1812 / 4532	3.60	1.50	3.00
2220 / 5750	5.50	1.50	4.20

**Multilayer varistors (MLVs)**
**Automotive series**
SMD
**Delivery mode**

EIA case size	Taping	Reel size mm	Packing unit pcs.	Type	Ordering code
0603	Blister	180	4000	CN0603K25HTG5	B72500H0250K062
0603	Cardboard	330	16000	CN0603S14BHTG2	B72500H0140S270
0603	Cardboard	180	4000	CN0603S17BHTG	B72500H0170S260
1210	Blister	180	3000	CN1210K17AUTOHTG	B72530H1170K062
1812	Blister	180	1500	CN1812K14G	B72580V0140K062
1812	Blister	180	1500	CN1812K14GK2	B72582V0140K062
1812	Blister	180	1500	CN1812K17G	B72580V0170K062
1812	Blister	180	1500	CN1812K20G	B72580V0200K062
1812	Blister	180	1000	CN1812K25G	B72580V0250K062
1812	Blister	180	1000	CN1812K30G	B72580V0300K062
1812	Blister	180	1000	CN1812K30GK2	B72582V0300K062
1812	Blister	330	3000	CN1812S14BAUTOE2G2	B72580V3140S272
1812	Blister	330	3000	CN1812S14BAUTOE2G2K2	B72582V3140S272
1812	Blister	180	1500	CN1812S14BAUTOG	B72580V1140S262
1812	Blister	180	1500	CN1812S14BAUTOGK2	B72582V1140S262
2220	Blister	180	1500	CN2220K14G	B72540V0140K062
2220	Blister	180	1500	CN2220K17G	B72540V0170K062
2220	Blister	180	1500	CN2220K20G	B72540V0200K062
2220	Blister	180	1500	CN2220K20GK2	B72542V0200K062
2220	Blister	180	1000	CN2220K25G	B72540V0250K062
2220	Blister	180	1000	CN2220K25GK2	B72542V0250K062
2220	Blister	330	3000	CN2220K30AUTOE2G2	B72540V3300K072
2220	Blister	330	3000	CN2220K30AUTOE2G2K2	B72542V3300K072
2220	Blister	180	1000	CN2220K30AUTOG	B72540V1300K062
2220	Blister	180	1000	CN2220K30AUTOGK2	B72542V1300K062
2220	Blister	180	1000	CN2220K30G	B72540V0300K062
2220	Blister	180	1000	CN2220K30GK2	B72542V0300K062
2220	Blister	330	3000	CN2220S14BAUTOE2G2	B72540V3140S272
2220	Blister	330	3000	CN2220S14BAUTOE2G2K2	B72542V3140S272
2220	Blister	180	1500	CN2220S14BAUTOG	B72540V1140S262
2220	Blister	180	1500	CN2220S14BAUTOGK2	B72542V1140S262
2220	Blister	330	3000	CN2220S14EAUTOE2G2K2	B72542V3140S572
0603	Cardboard	180	4000	CT0603K14G	B72500T0140K060
0603	Cardboard	180	4000	CT0603K17CCG	B72500T5170K060
0603	Cardboard	180	4000	CT0603K17G	B72500T0170K060
0603	Cardboard	180	4000	CT0603K17LCG	B72500T2170K060
0603	Cardboard	180	4000	CT0603K20G	B72500T0200K060
0603	Cardboard	180	4000	CT0603K25G	B72500T0250K060
0603	Cardboard	180	4000	CT0603L25HSG	B72500T8250L060
0603	Cardboard	180	4000	CT0603S14AHSG	B72500T8140S160
0603	Cardboard	180	4000	CT0603S14BAUTOG	B72500T1140S260
0603	Cardboard	180	4000	CT0603S14BG	B72500T0140S160

**Multilayer varistors (MLVs)**
**Automotive series**
SMD

EIA case size	Taping	Reel size mm	Packing unit pcs.	Type	Ordering code
0603	Cardboard	180	4000	CT0603S17ALCG	B72500T2170S160
0603	Cardboard	180	4000	CT0603S17BCCG	B72500T5170S260
0603	Cardboard	180	4000	CT0603S20ACCG	B72500T5200S160
0805	Blister	180	3000	CT0805K14G	B72510T0140K062
0805	Blister	180	3000	CT0805K17AUTOLCG	B72510S2170K062
0805	Blister	180	3000	CT0805K17G	B72510T0170K062
0805	Blister	180	3000	CT0805K17LCG	B72510T2170K062
0805	Blister	180	3000	CT0805K20G	B72510T0200K062
0805	Blister	180	3000	CT0805K25AUTOG	B72510T1250K062
0805	Blister	180	3000	CT0805K25CCG	B72510T5250K062
0805	Blister	180	3000	CT0805K25G	B72510T0250K062
0805	Blister	180	3000	CT0805K30G	B72510T0300K062
0805	Blister	180	3000	CT0805S14BAUTOG	B72510T1140S262
0805	Blister	330	12000	CT0805S20ACC2G2	B72510T9200S172
1206	Blister	180	3000	CT1206K14G	B72520T0140K062
1206	Blister	180	3000	CT1206K17G	B72520T0170K062
1206	Blister	180	3000	CT1206K20AUTOG	B72520T1200K062
1206	Blister	180	3000	CT1206K20G	B72520T0200K062
1206	Blister	180	2000	CT1206K25AUTOG	B72520T1250K062
1206	Blister	180	2000	CT1206K25G	B72520T0250K062
1206	Blister	180	2000	CT1206K30G	B72520T0300K062
1206	Blister	180	3000	CT1206S14BAUTOG	B72520T1140S262
1210	Blister	180	3000	CT1210K14G	B72530T0140K062
1210	Blister	180	3000	CT1210K17AUTOG	B72530T1170K062
1210	Blister	180	2000	CT1210K17G	B72530T0170K062
1210	Blister	180	3000	CT1210K20AUTOG	B72530T1200K062
1210	Blister	180	3000	CT1210K20G	B72530T0200K062
1210	Blister	180	2000	CT1210K25AUTOG	B72530T1250K062
1210	Blister	180	2000	CT1210K25G	B72530T0250K062
1210	Blister	180	2000	CT1210K30G	B72530T0300K062
1210	Blister	180	3000	CT1210S14BAUTOG	B72530T1140S262

**Multilayer varistors (MLVs)**

**Automotive series**

**SMD**

**V/I characteristics for automotive range, CN types**

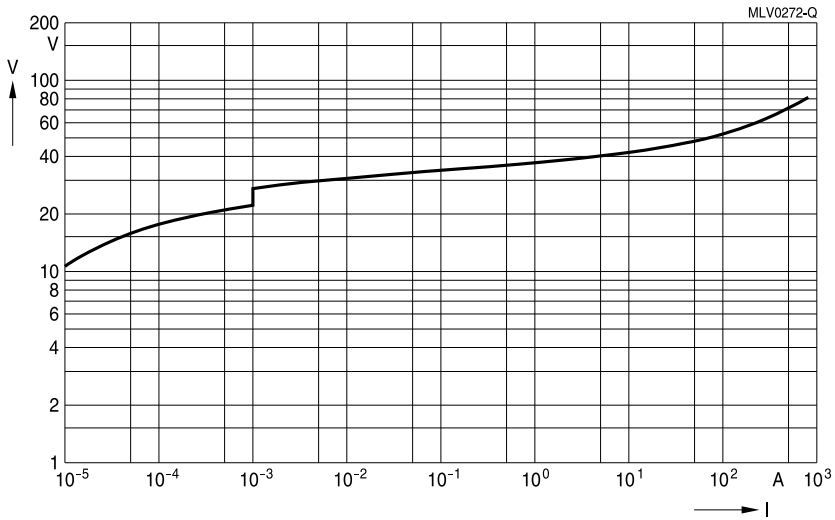

**CN1812S14BAUTOE2G2(K2)**

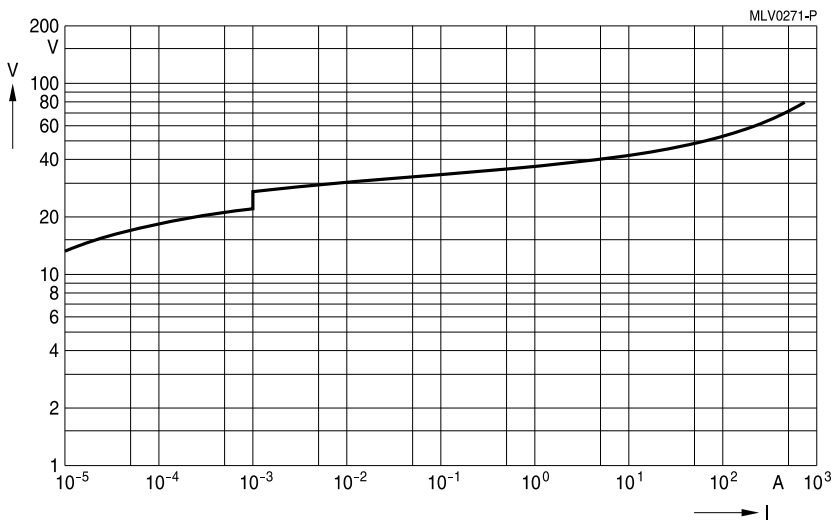

**CN1812S14BAUTOG(K2)**

**Multilayer varistors (MLVs)**

**Automotive series**

**SMD**

**V/I characteristics for automotive range, CN types**

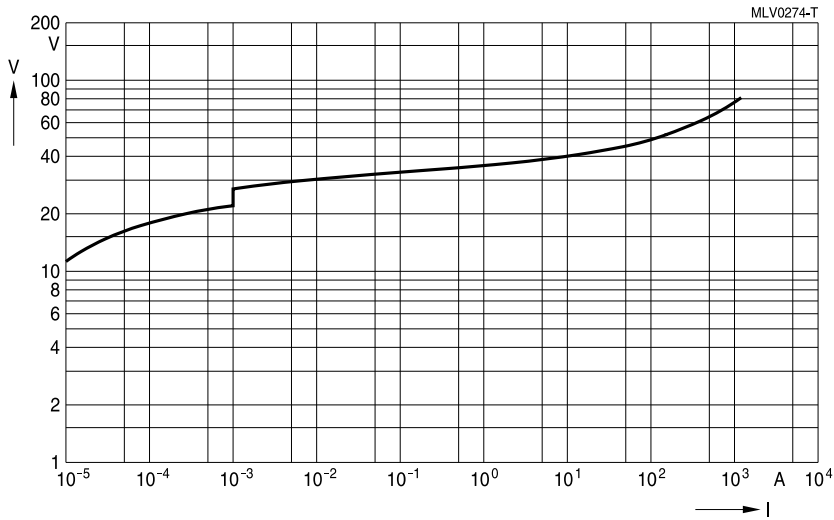

**CN2220S14BAUTOE2G2(K2)**

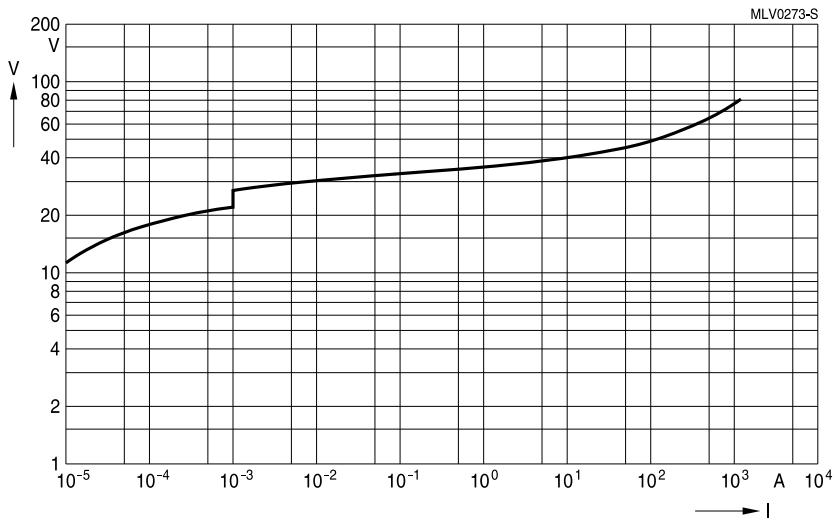

**CN2220S14BAUTOG(K2)**

**Multilayer varistors (MLVs)**

**Automotive series**

**SMD**

**V/I characteristics for automotive range, CN types**

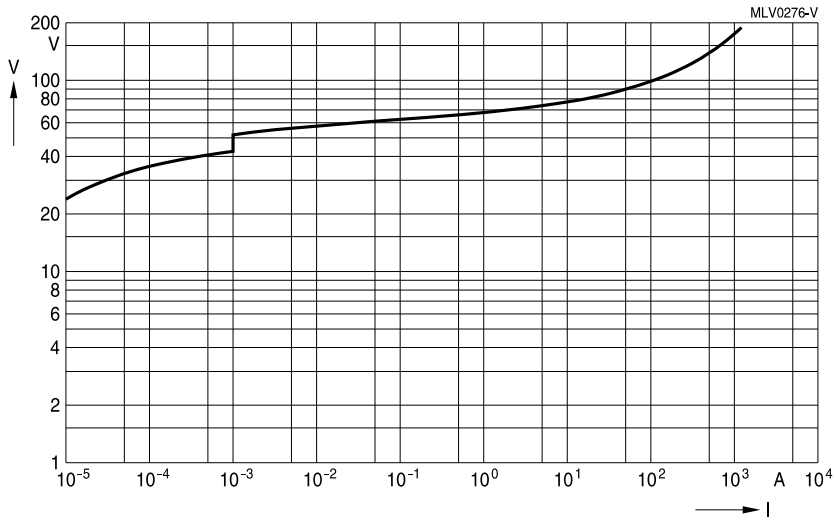

**CN2220K30AUTOE2G2(K2)**

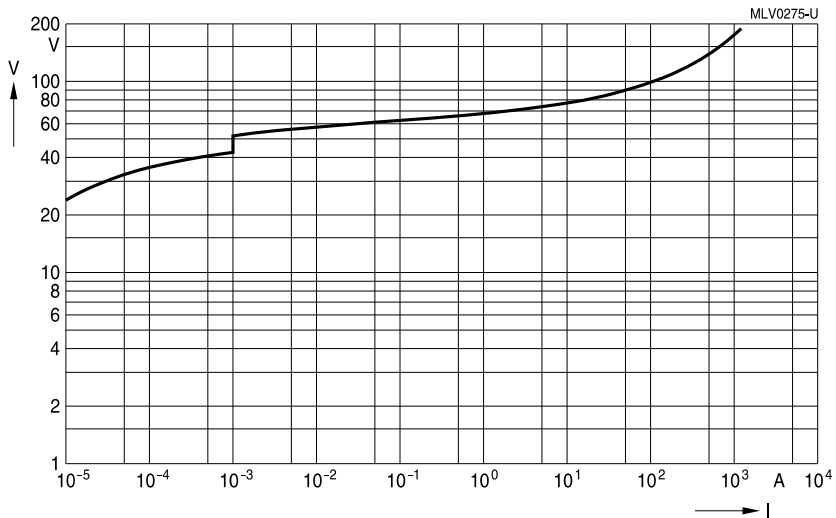

**CN2220K30AUTOG(K2)**



**Multilayer varistors (MLVs)**

**Automotive series**

**SMD**

**V/I characteristics for automotive range, CN types**

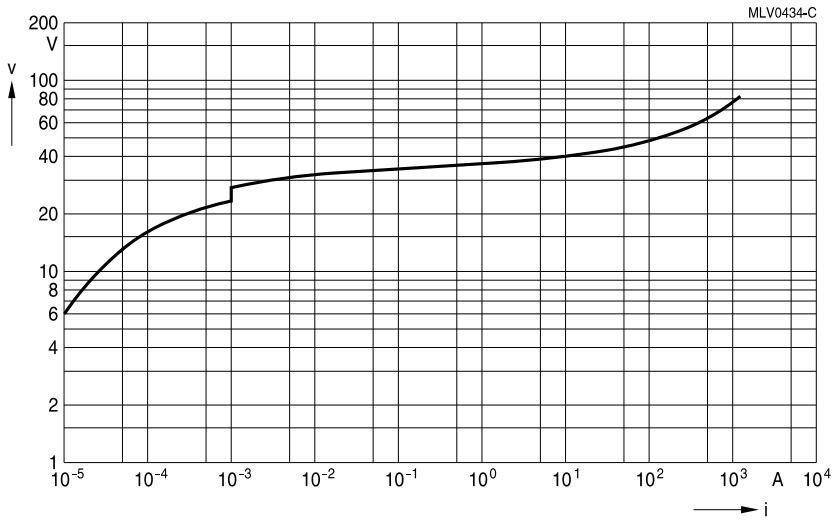

CN2220S14EAUTOE2G2K2

Multilayer varistors (MLVs)

Automotive series

SMD

V/I characteristics for automotive range, CT types

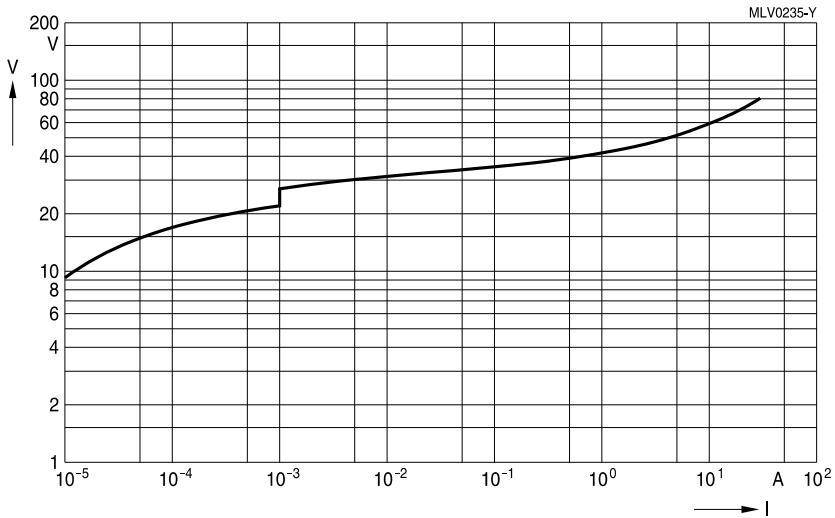

CT0603S14BAUTOG

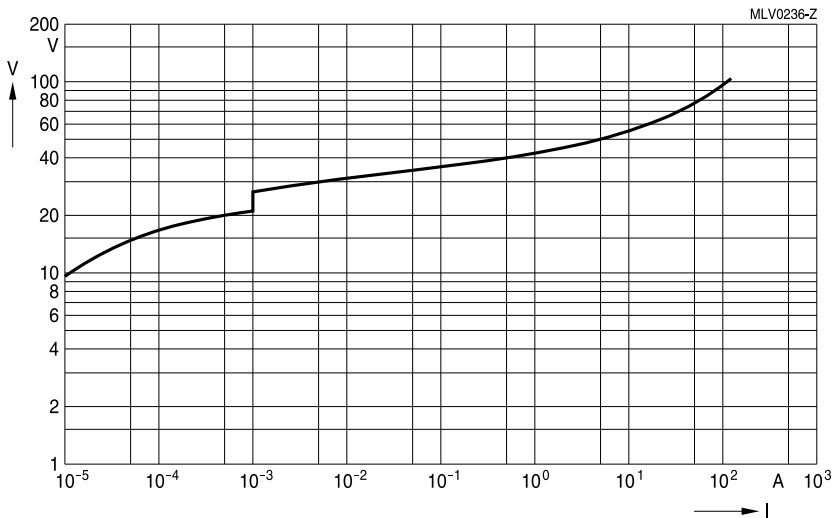

CT0805S14BAUTOG

**Multilayer varistors (MLVs)**

**Automotive series**

**SMD**

**V/I characteristics for automotive range, CT types**

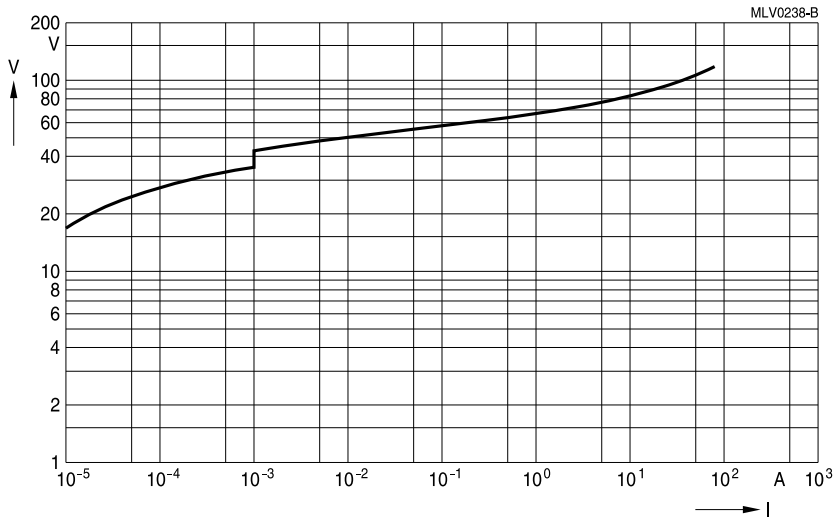

**CT0805K25AUTOG**

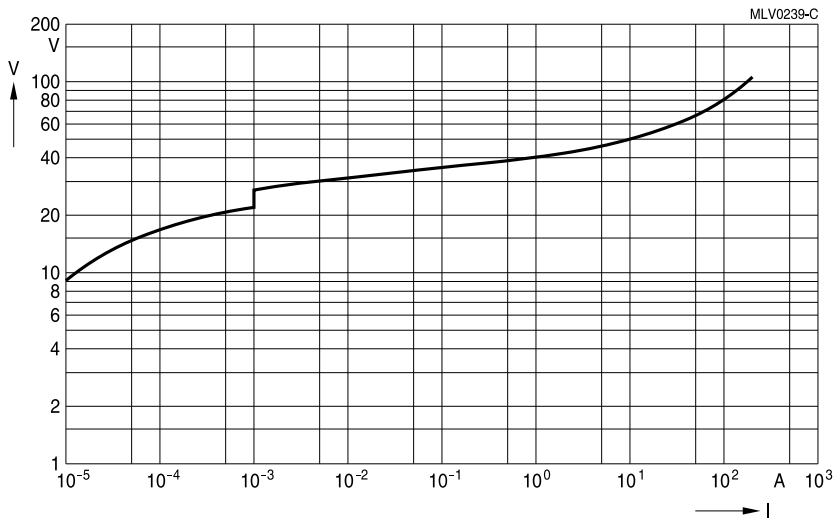

**CT1206S14BAUTOG**

**Multilayer varistors (MLVs)**

**Automotive series**

**SMD**

**V/I characteristics for automotive range, CT types**

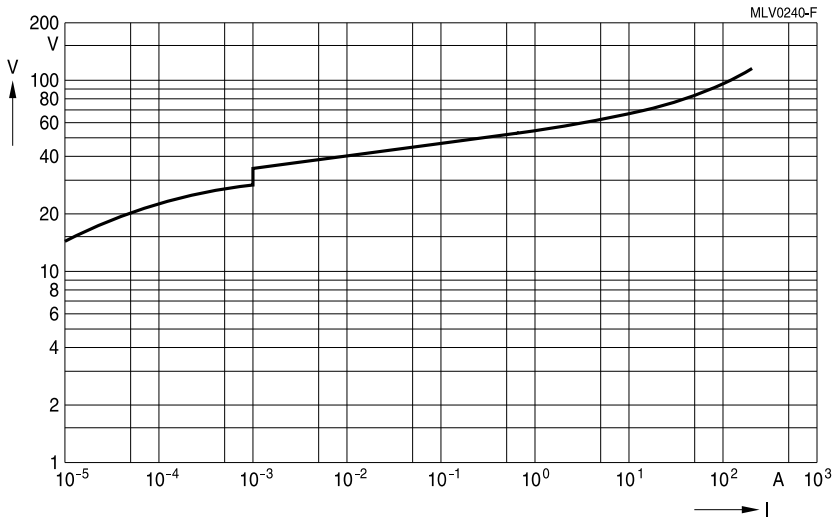

**CT1206K20AUTOG**

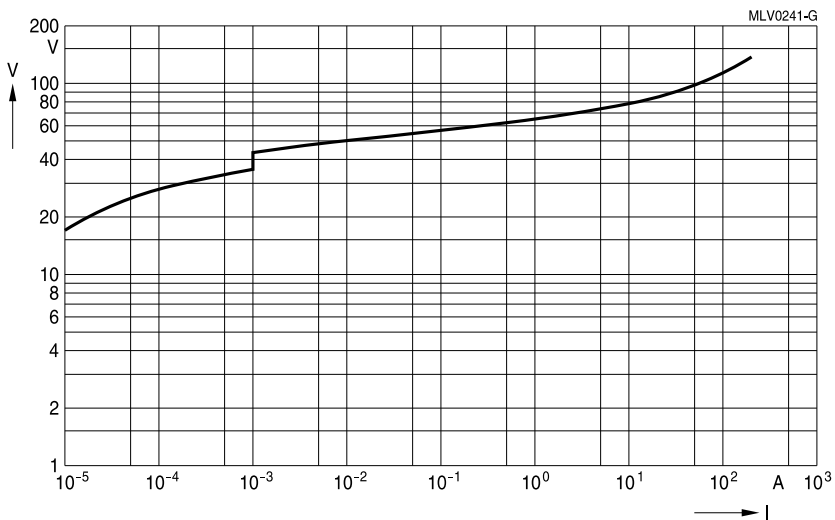

**CT1206K25AUTOG**

**Multilayer varistors (MLVs)**

**Automotive series**

**SMD**

**V/I characteristics for automotive range, CT types**

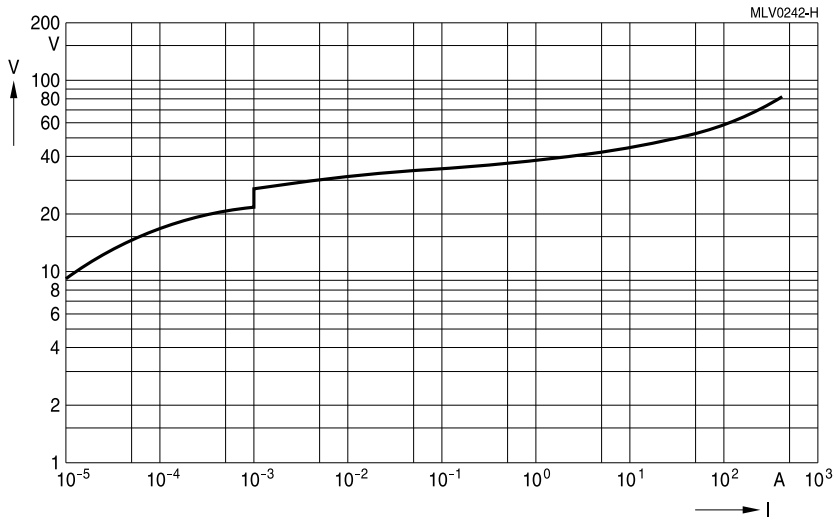

**CT1210S14BAUTOG**

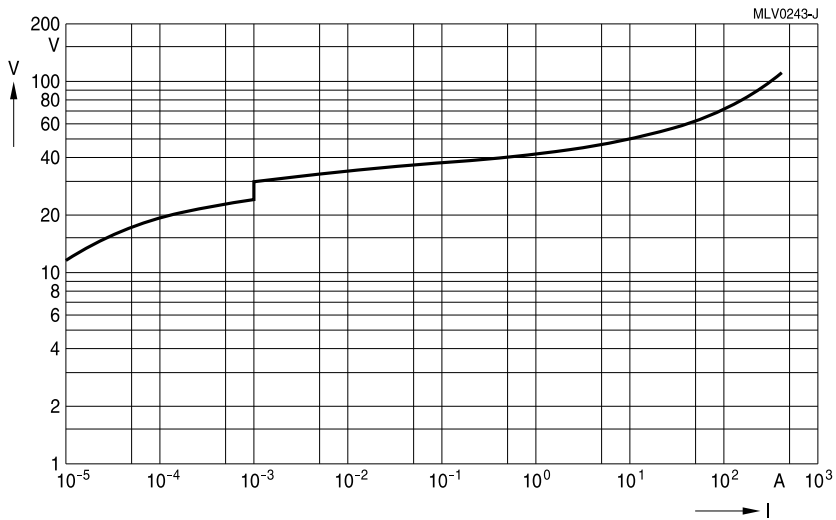

**CT1210K17AUTOG**

**Multilayer varistors (MLVs)**

**Automotive series**

**SMD**

**V/I characteristics for automotive range, CT types**

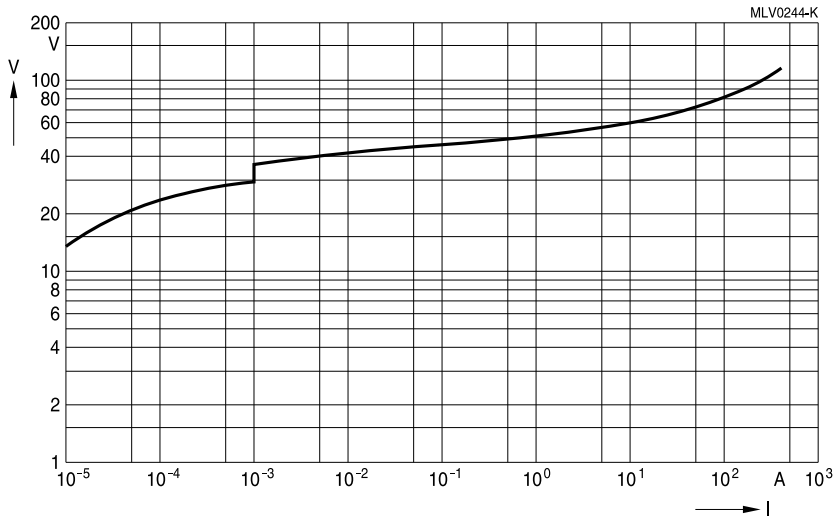

**CT1210K20AUTOG**

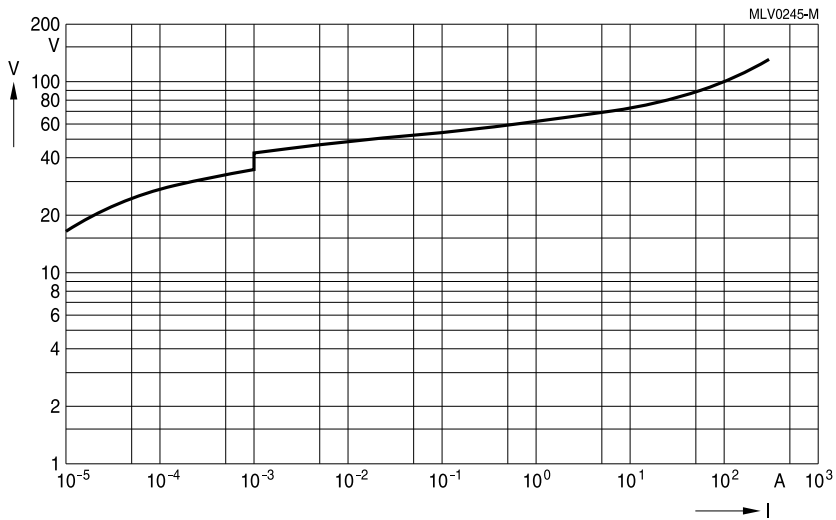

**CT1210K25AUTOG**

**Multilayer varistors (MLVs)**

**Automotive series**

**SMD**

**V/I characteristics for high temperature (HT) range**

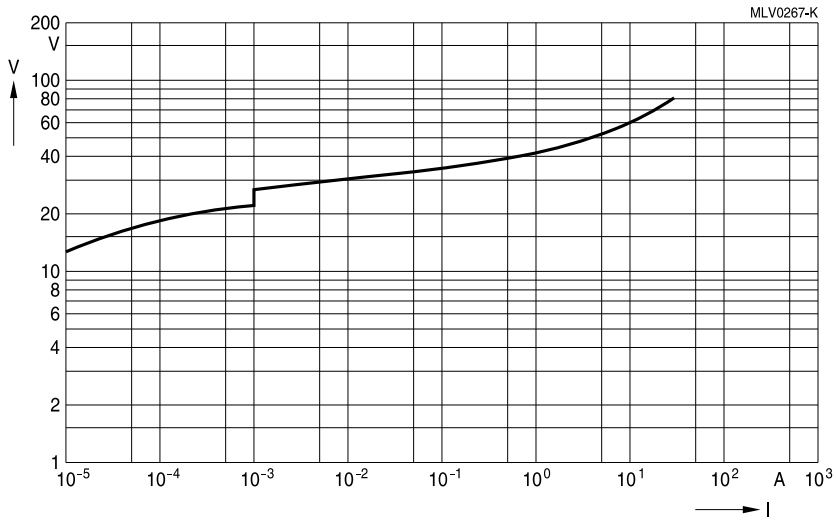

**CN0603S14BHTG2**

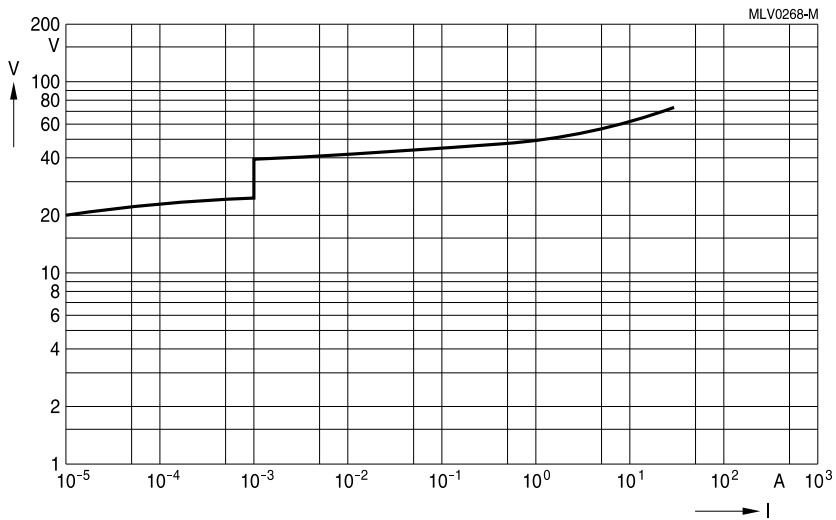

**CN0603S17BHTG**

**Multilayer varistors (MLVs)**

**Automotive series**

**SMD**

**V/I characteristics for high temperature (HT) range**

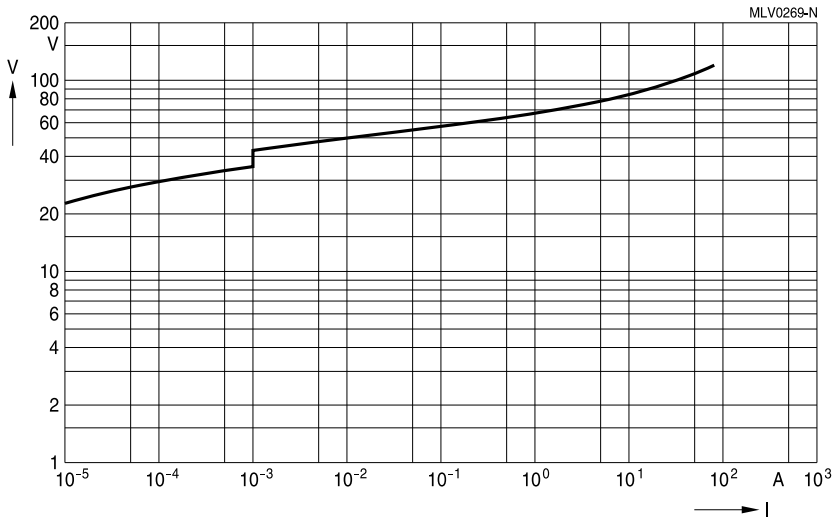

**CN0603K25HTG**

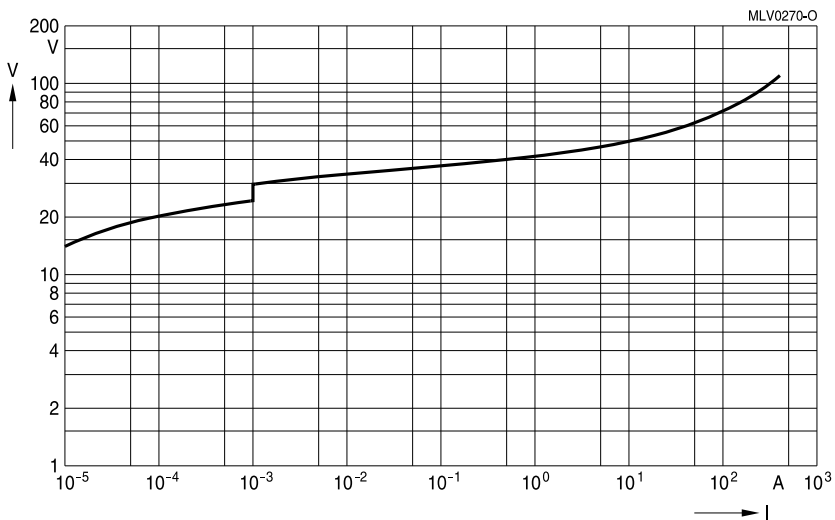

**CN1210K17AUTOHTG**



**Multilayer varistors (MLVs)**

**Automotive series**

**SMD**

**V/I characteristics for special capacitance range**

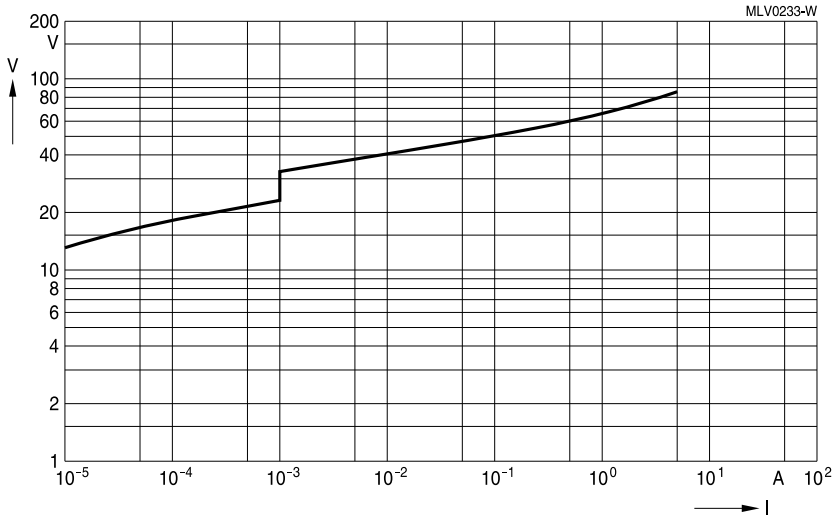

**CT0603S14AHSG**

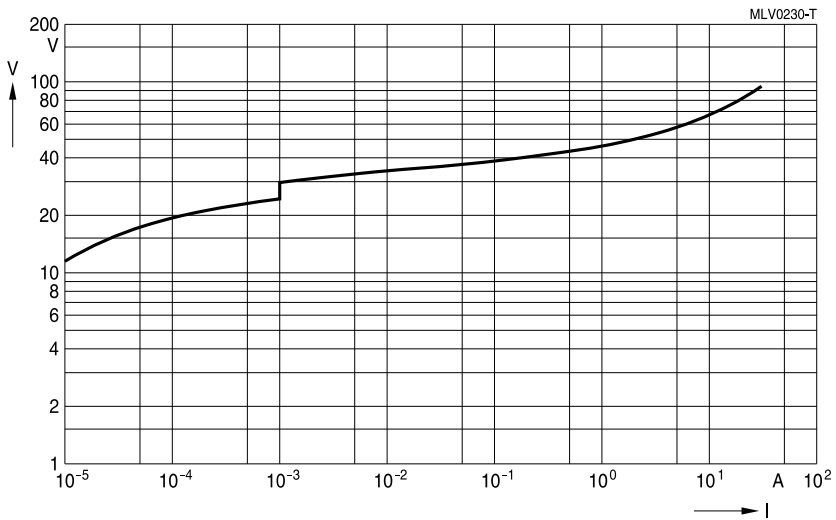

**CT0603K17CCG**

**Multilayer varistors (MLVs)**

**Automotive series**

**SMD**

**V/I characteristics for special capacitance range**

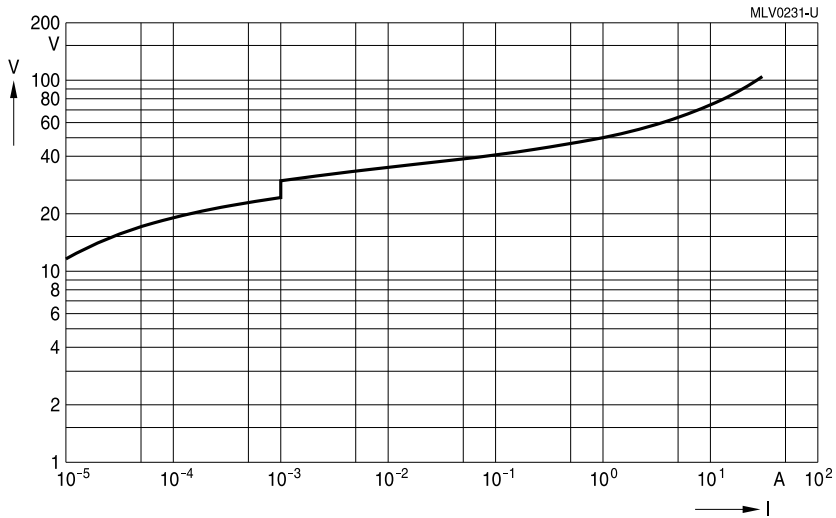

**CT0603K17LCG**

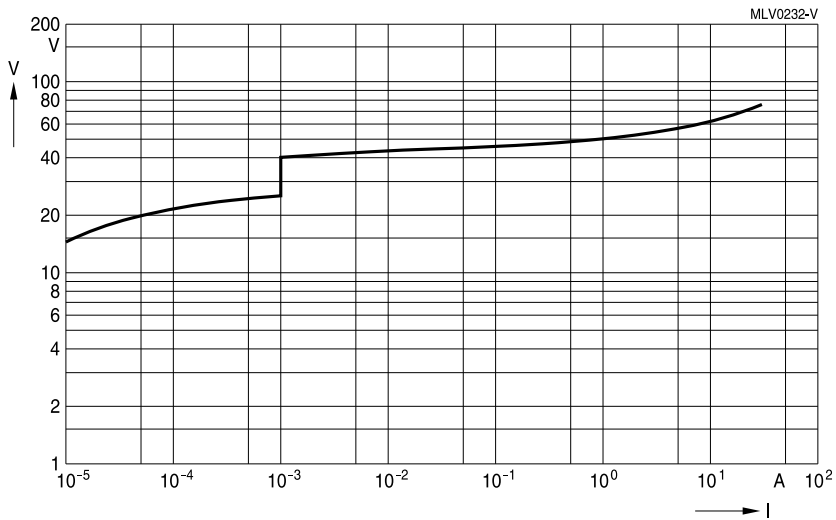

**CT0603S17ALCG**  
**CT0603S17BCCG**

**Multilayer varistors (MLVs)**

**Automotive series**

**SMD**

**V/I characteristics for special capacitance range**

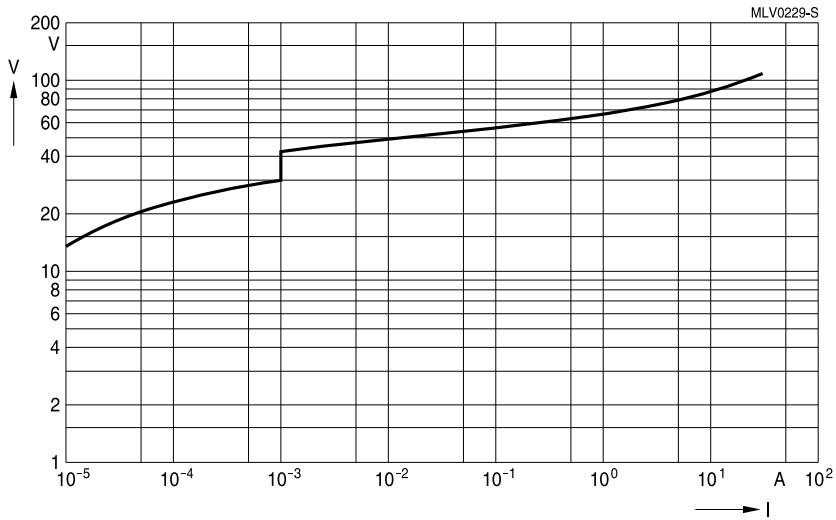

**CT0603S20ACCG**

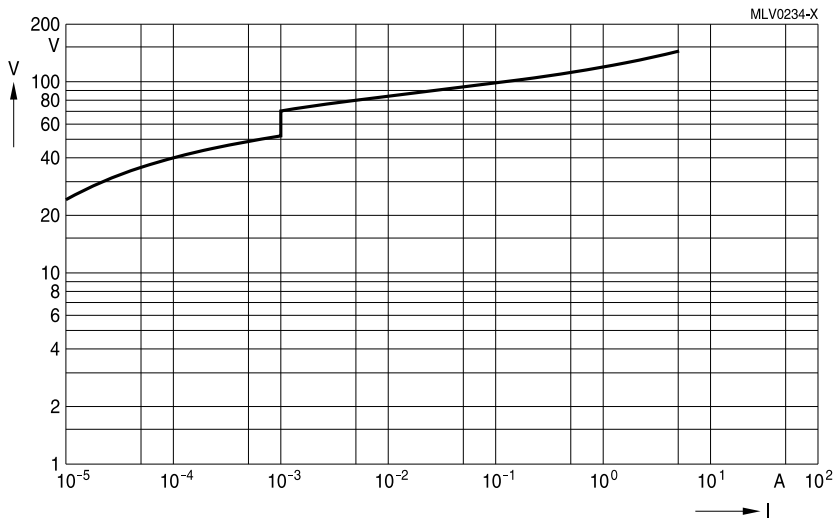

**CT0603L25HSG**

Multilayer varistors (MLVs)

Automotive series

SMD

V/I characteristics for special capacitance range

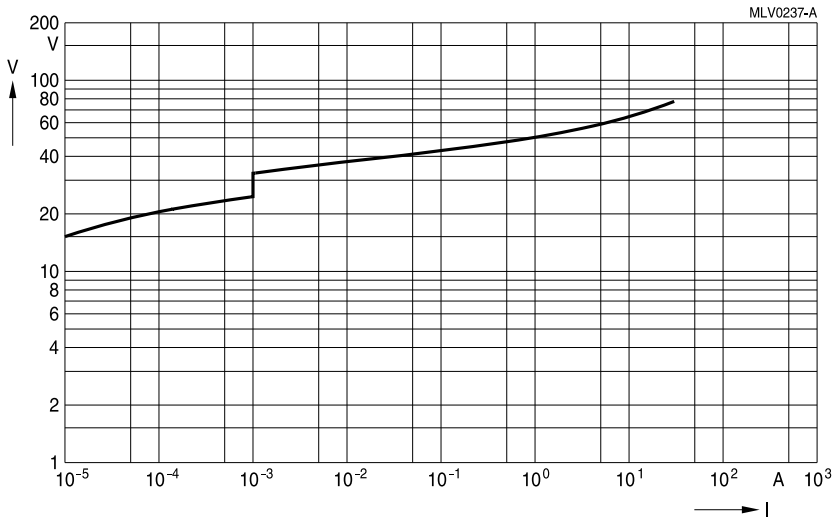

CT0805K17LCG

CT0805K17AUTLCG

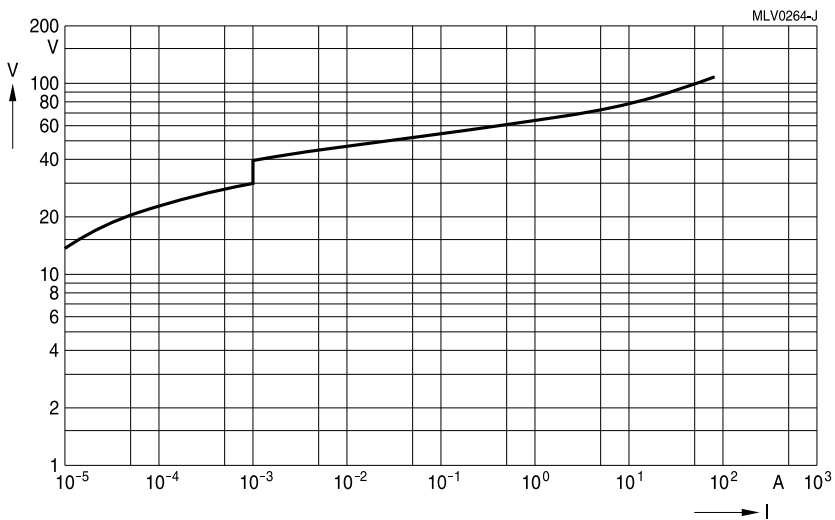

CT0805S20ACC2G2

**Multilayer varistors (MLVs)**

**Automotive series**

**SMD**

**V/I characteristics for special capacitance range**

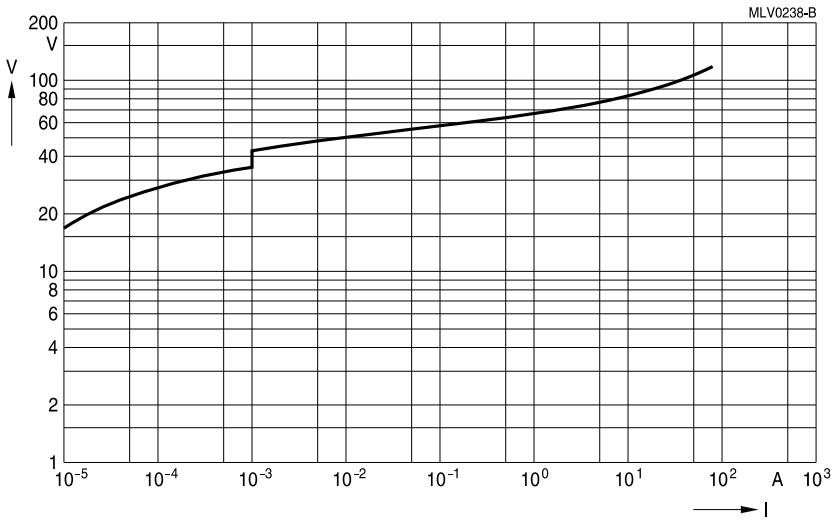

CT0805K25CCG

**Multilayer varistors (MLVs)**

**Automotive series**

**SMD**

**V/I characteristics for standard range, CN types**

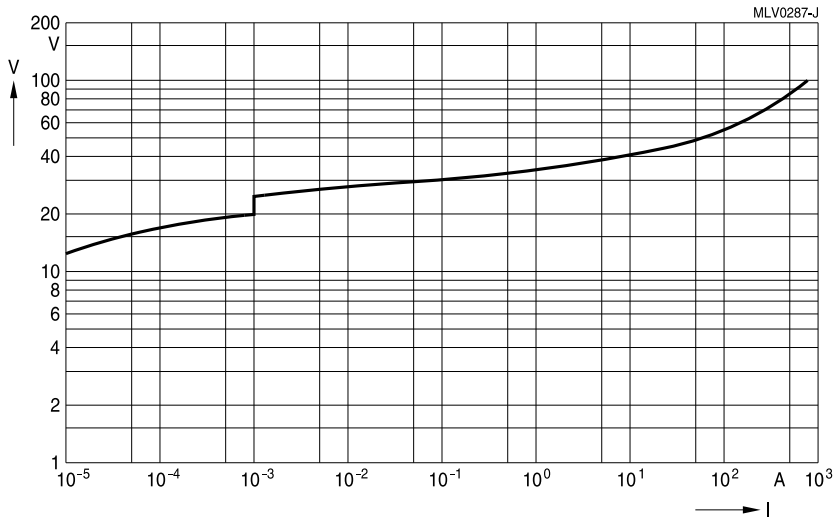

**CN1812K14G(K2)**

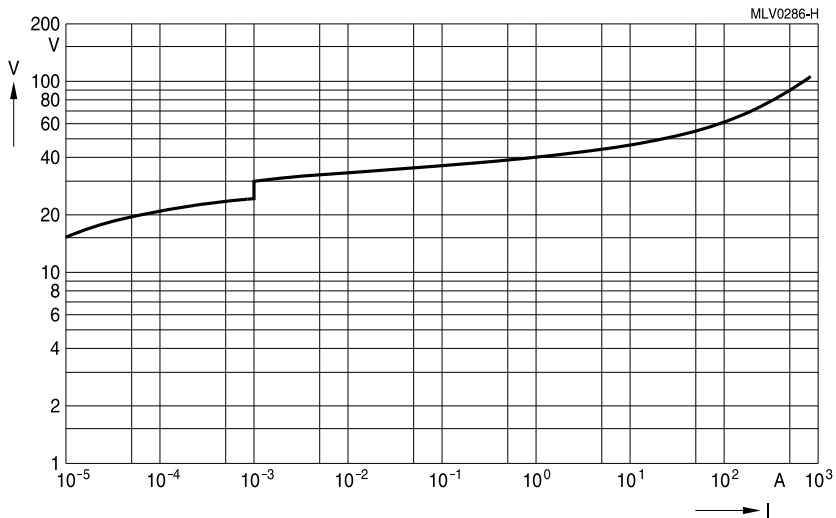

**CN1812K17G**

**Multilayer varistors (MLVs)**

**Automotive series**

**SMD**

**V/I characteristics for standard range, CN types**

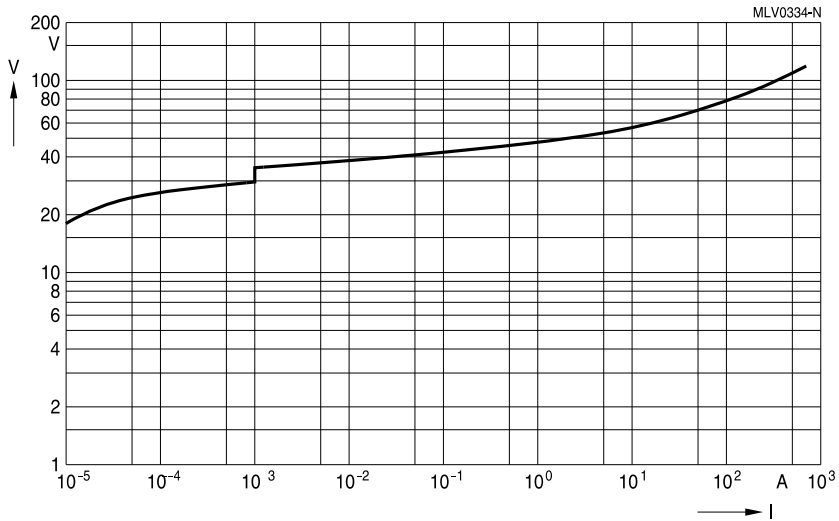

**CN1812K20G**

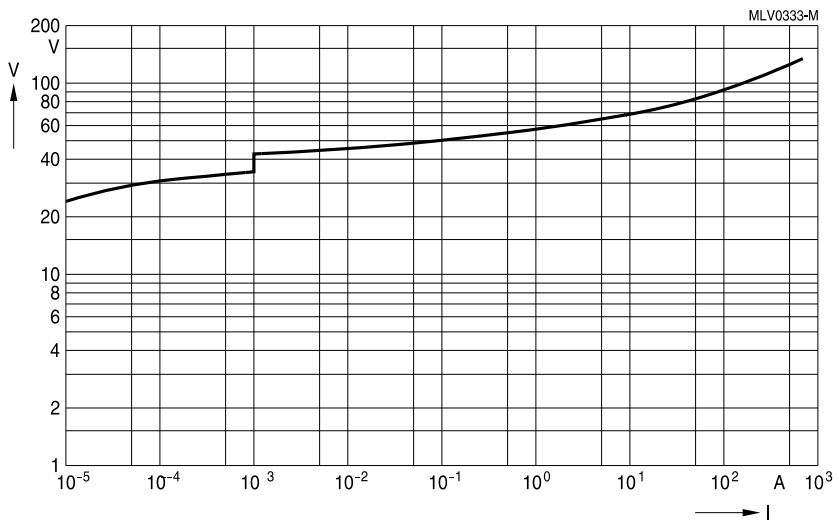

**CN1812K25G**

**Multilayer varistors (MLVs)**

**Automotive series**

**SMD**

**V/I characteristics for standard range, CN types**

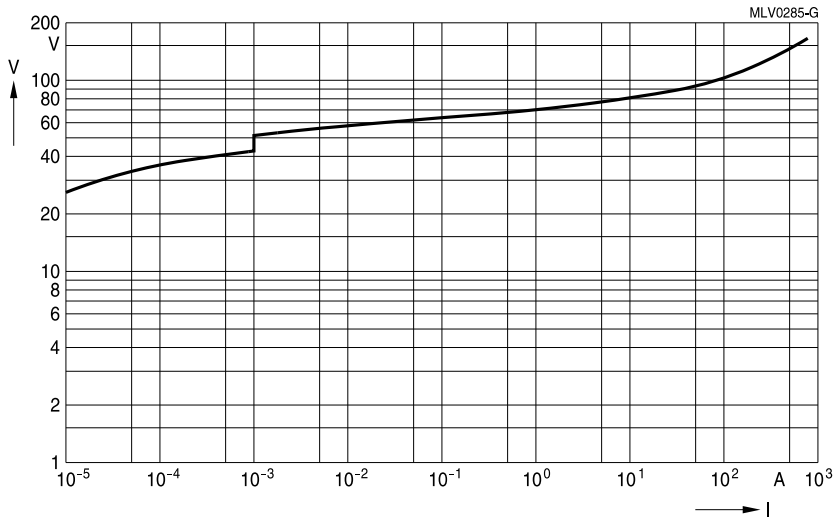

**CN1812K30G(K2)**

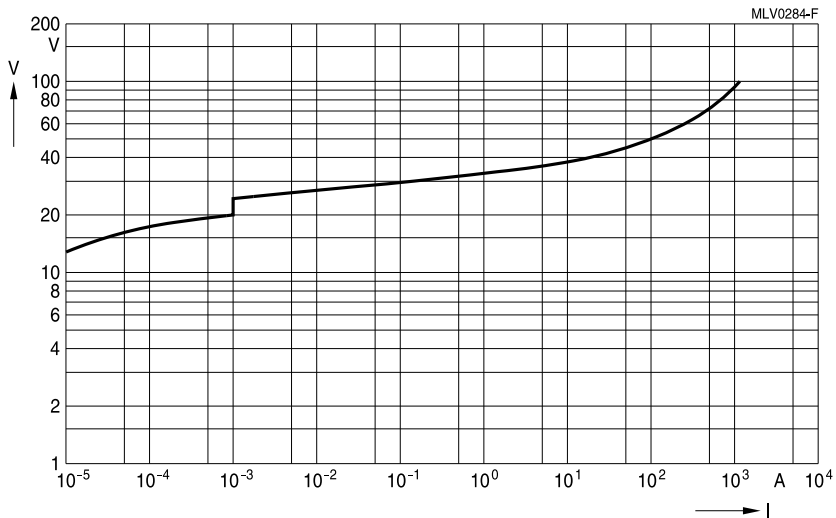

**CN2220K14G**



**Multilayer varistors (MLVs)**

**Automotive series**

**SMD**

**V/I characteristics for standard range, CN types**

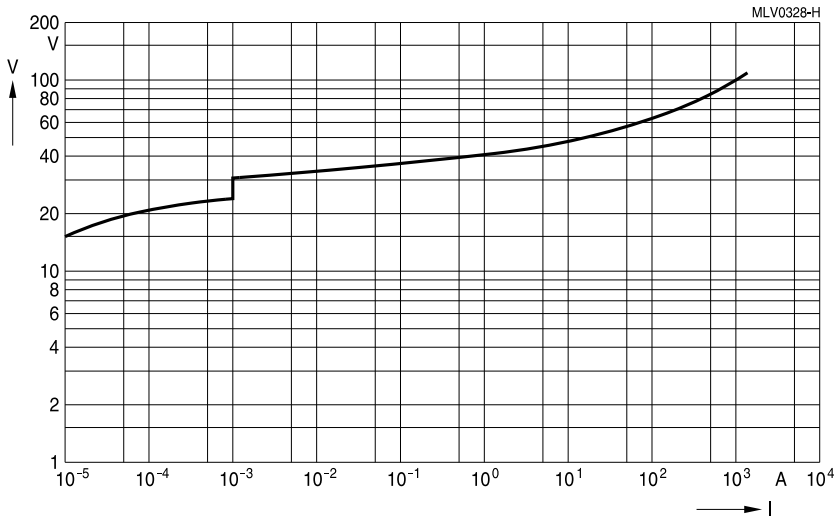

**CN2220K17G**

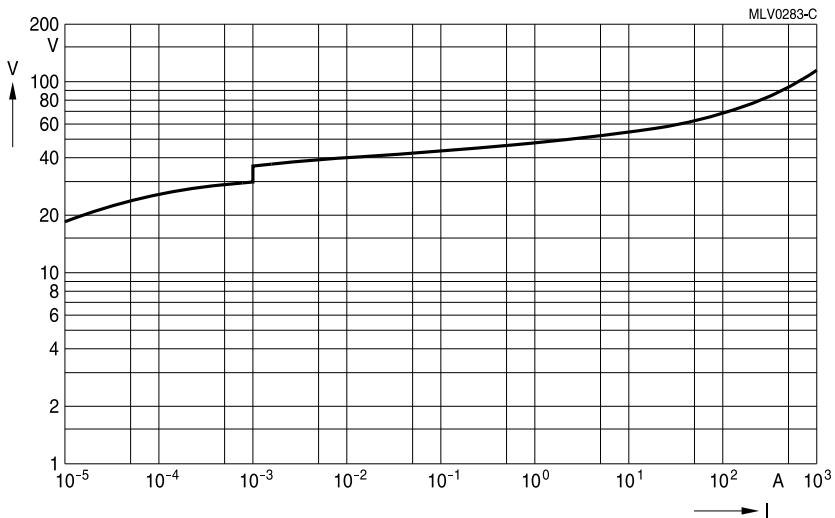

**CN2220K20G(K2)**

Multilayer varistors (MLVs)

Automotive series

SMD

V/I characteristics for standard range, CN types

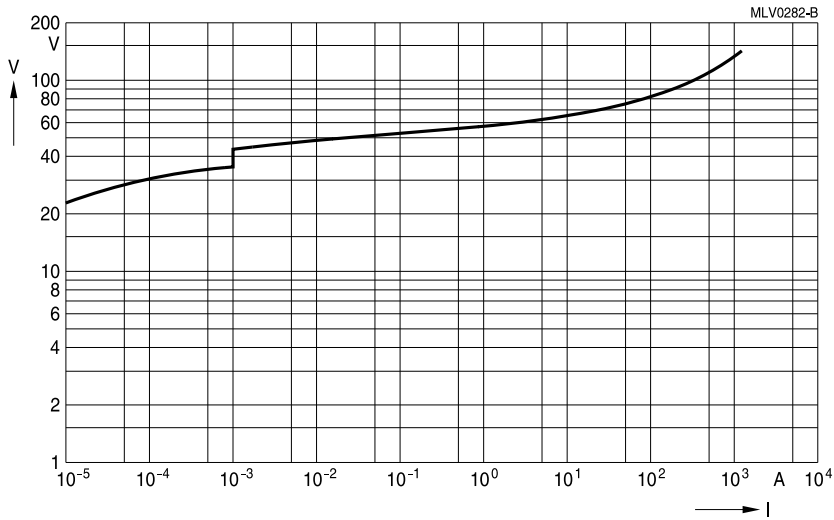

CN2220K25G(K2)

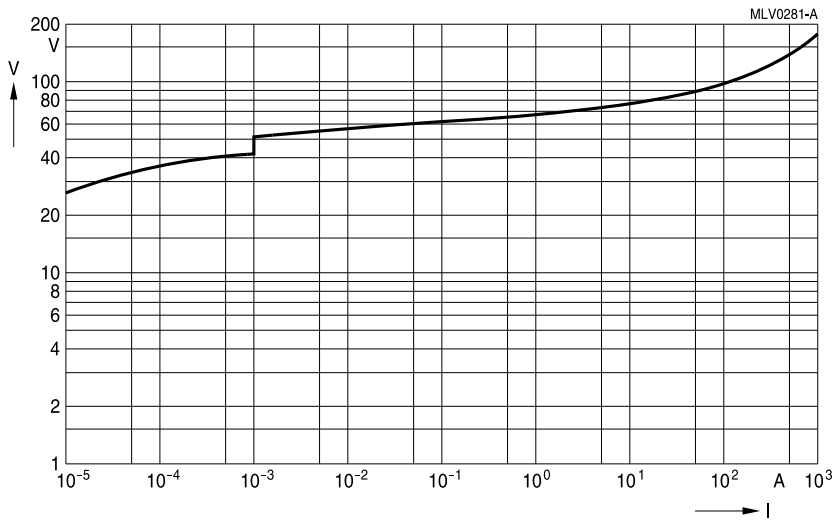

CN2220K30G(K2)

**Multilayer varistors (MLVs)**

**Automotive series**

**SMD**

**V/I characteristics for standard range, CT types**

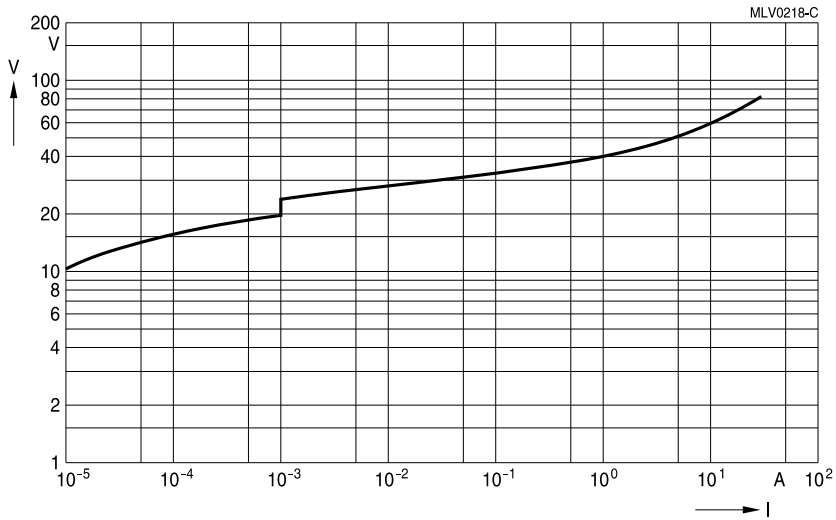

**CT0603K14G**

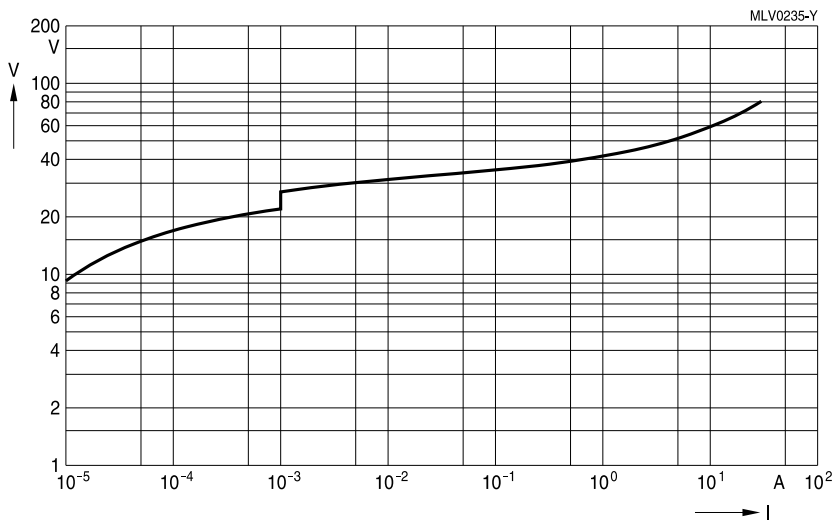

**CT0603S14BG**

**Multilayer varistors (MLVs)**

**Automotive series**

**SMD**

**V/I characteristics for standard range, CT types**

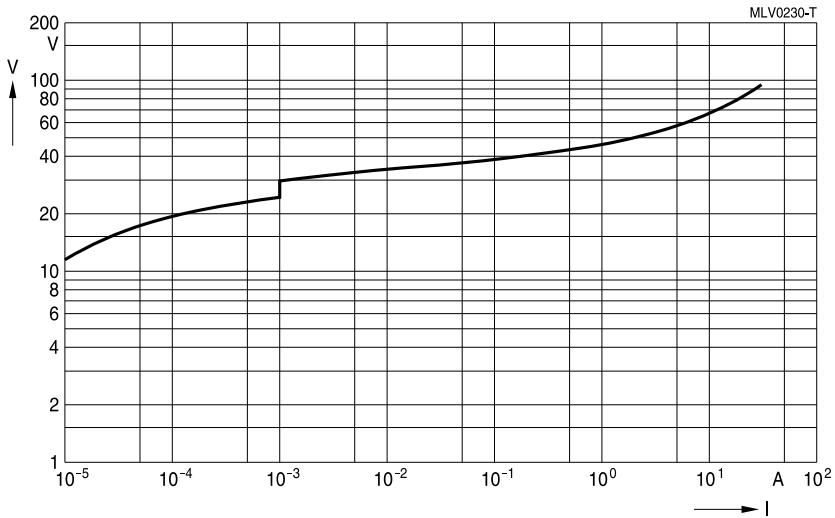

**CT0603K17G**

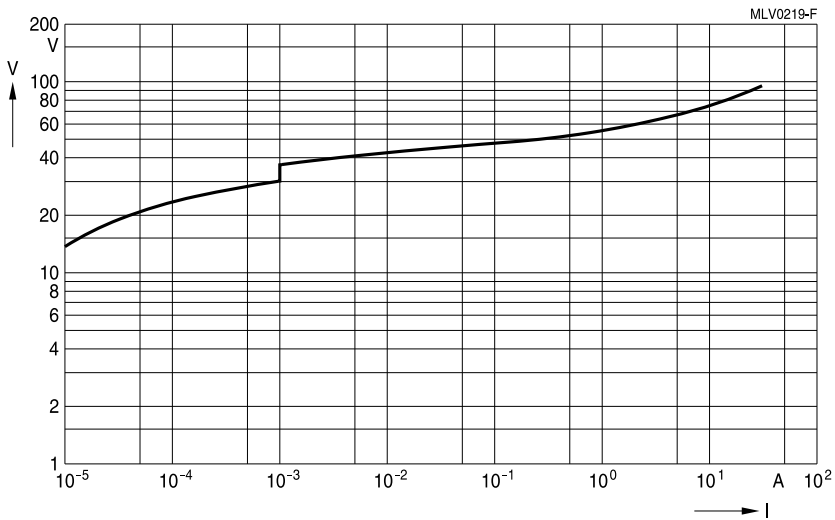

**CT0603K20G**

Multilayer varistors (MLVs)

Automotive series

SMD

V/I characteristics for standard range, CT types

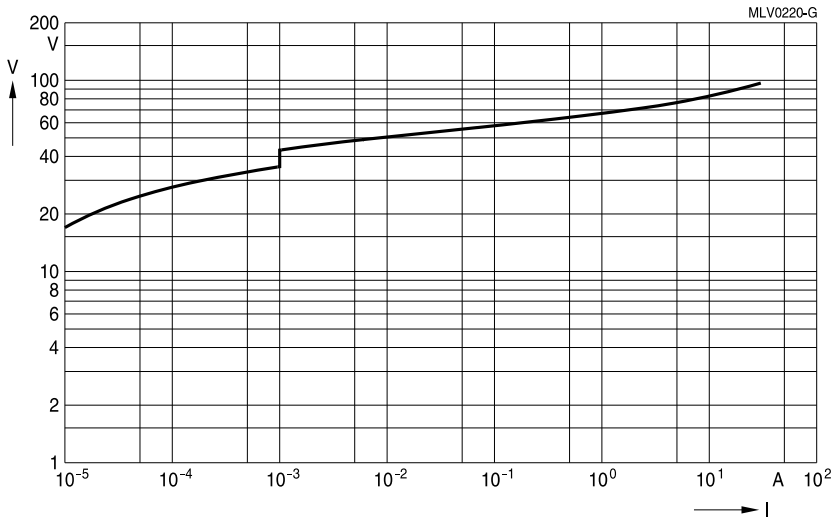

CT0603K25G

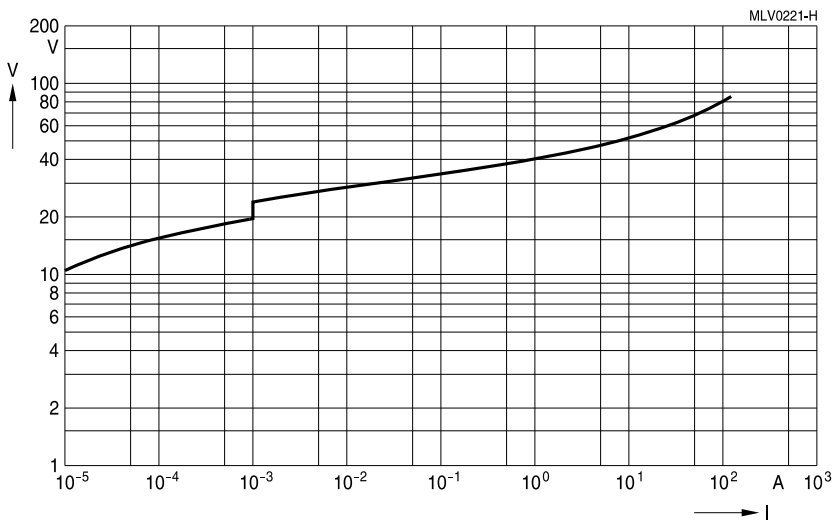

CT0805K14G

**Multilayer varistors (MLVs)**

**Automotive series**

**SMD**

**V/I characteristics for standard range, CT types**

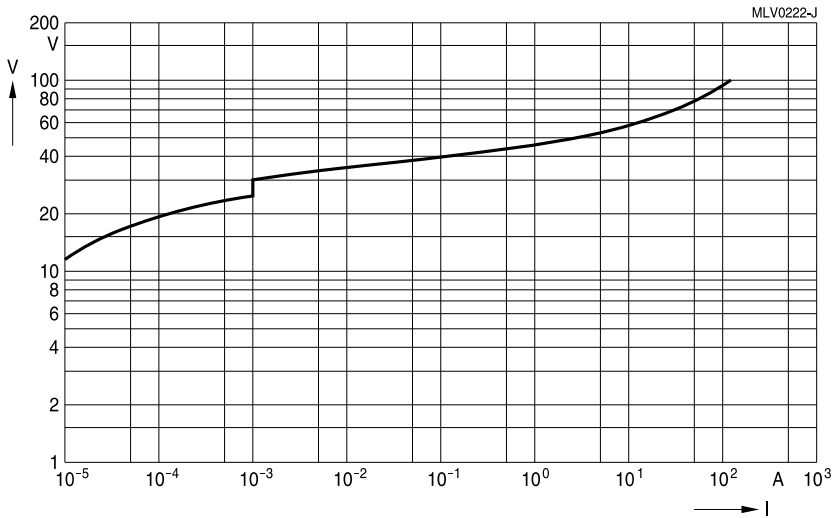

**CT0805K17G**

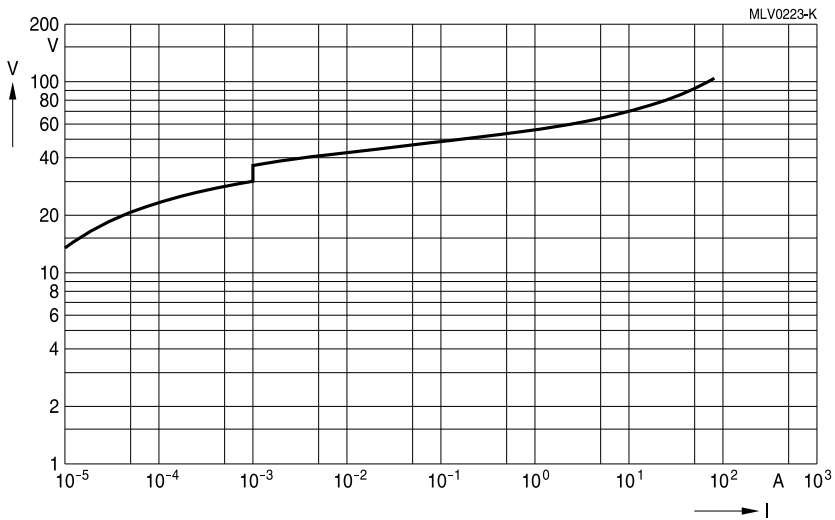

**CT0805K20G**

Multilayer varistors (MLVs)

Automotive series

SMD

V/I characteristics for standard range, CT types

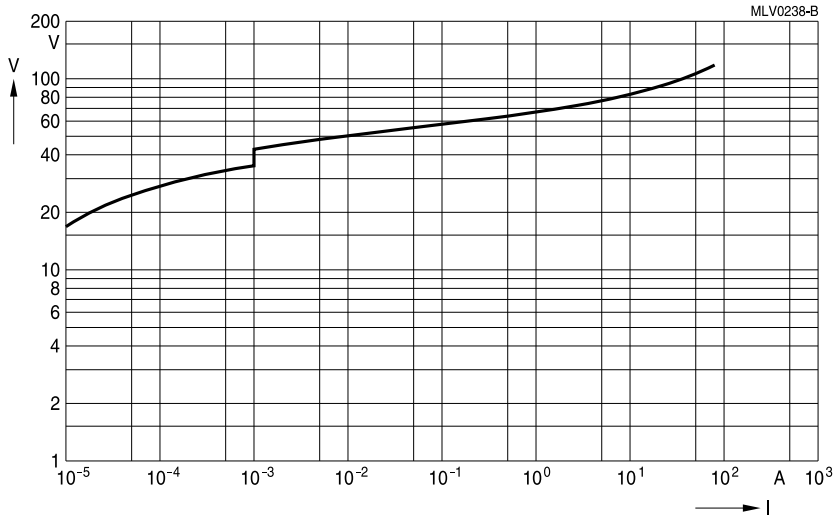

CT0805K25G

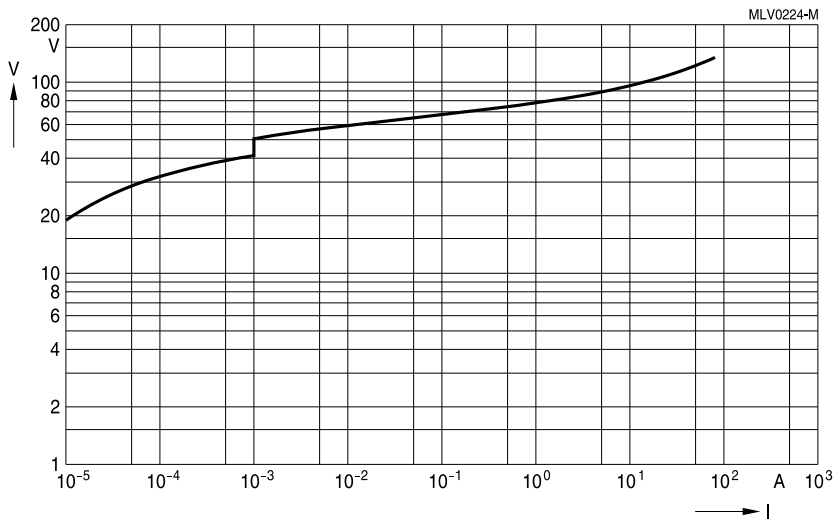

CT0805K30G

**Multilayer varistors (MLVs)**

**Automotive series**

**SMD**

**V/I characteristics for standard range, CT types**

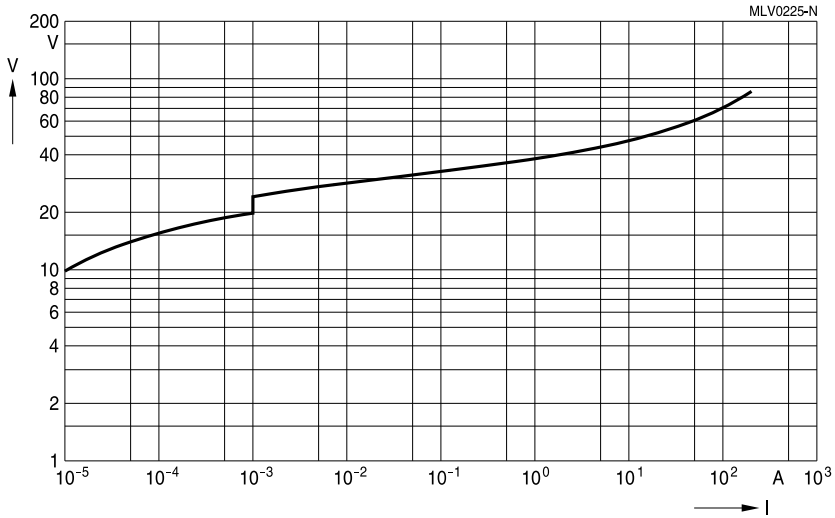

**CT1206K14G**

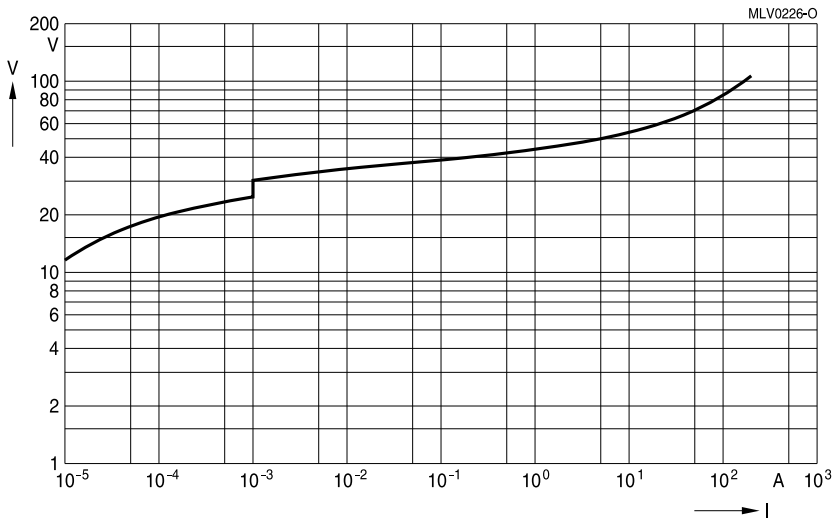

**CT1206K17G**



Multilayer varistors (MLVs)

Automotive series

SMD

V/I characteristics for standard range, CT types

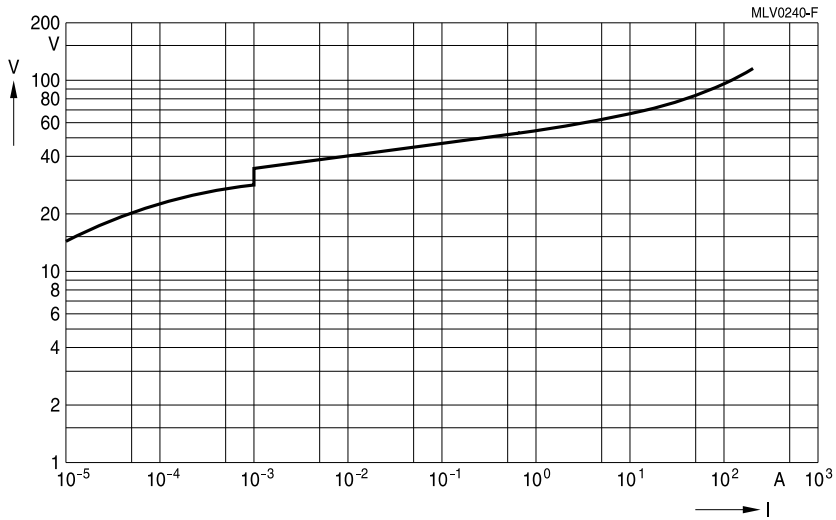

CT1206K20G

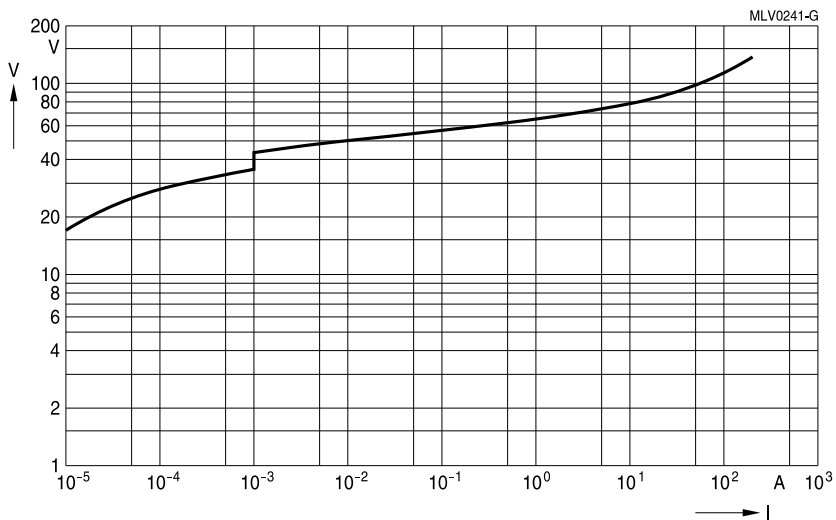

CT1206K25G

Multilayer varistors (MLVs)

Automotive series

SMD

V/I characteristics for standard range, CT types

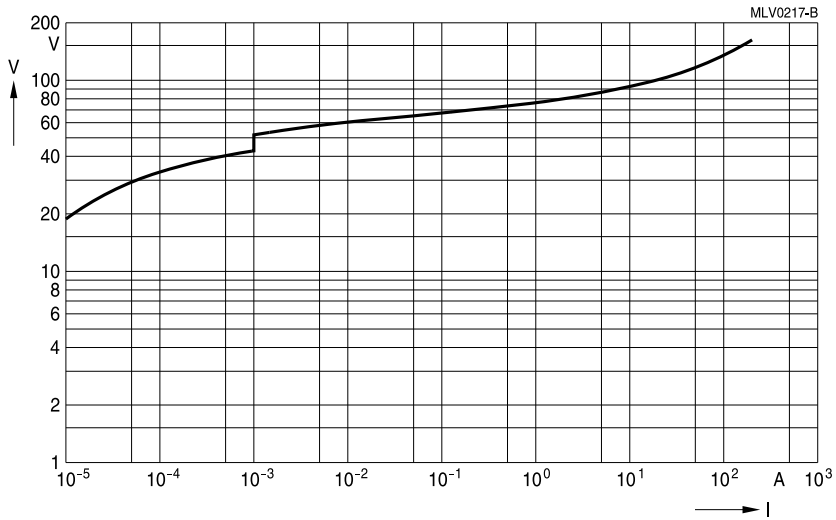

CT1206K30G

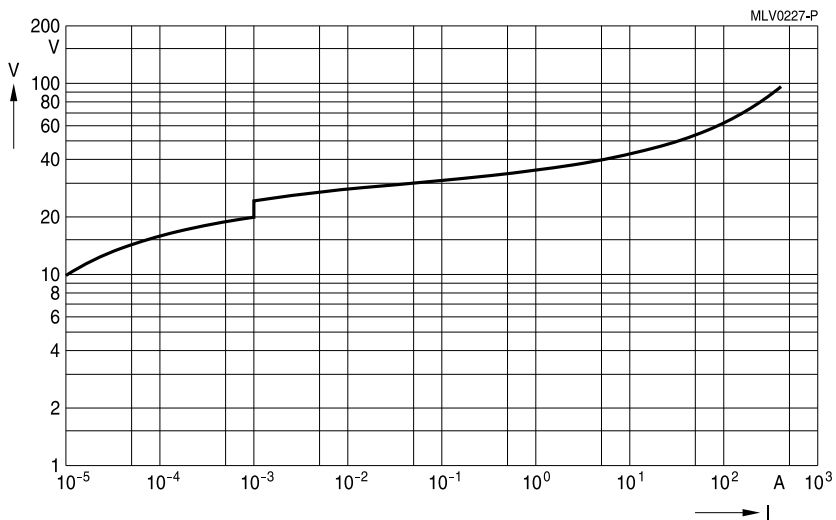

CT1210K14G

**Multilayer varistors (MLVs)**

**Automotive series**

**SMD**

**V/I characteristics for standard range, CT types**

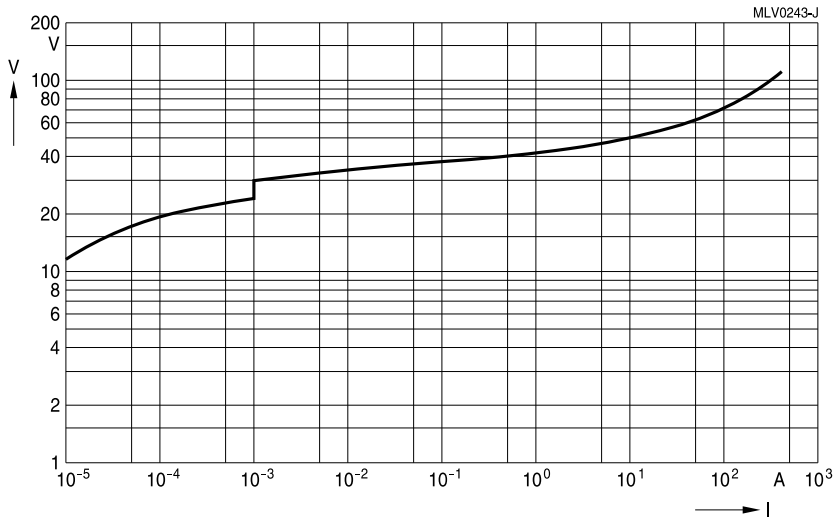

**CT1210K17G**

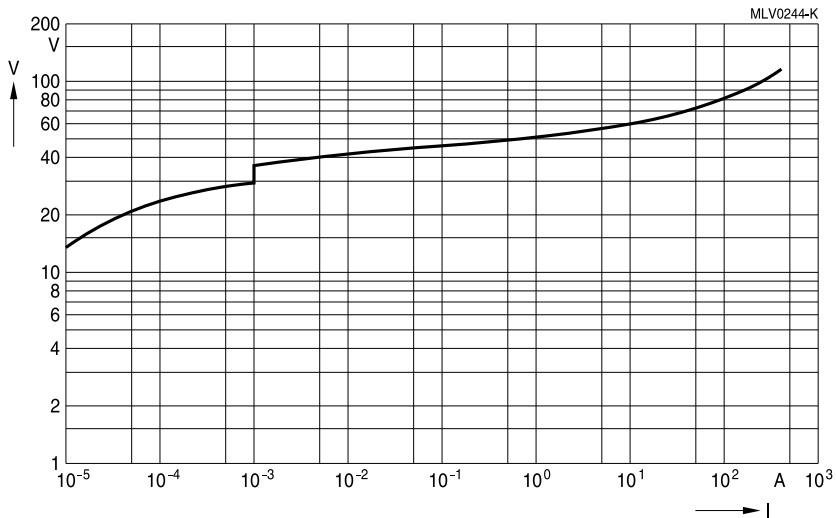

**CT1210K20G**

**Multilayer varistors (MLVs)**

**Automotive series**

**SMD**

**V/I characteristics for standard range, CT types**

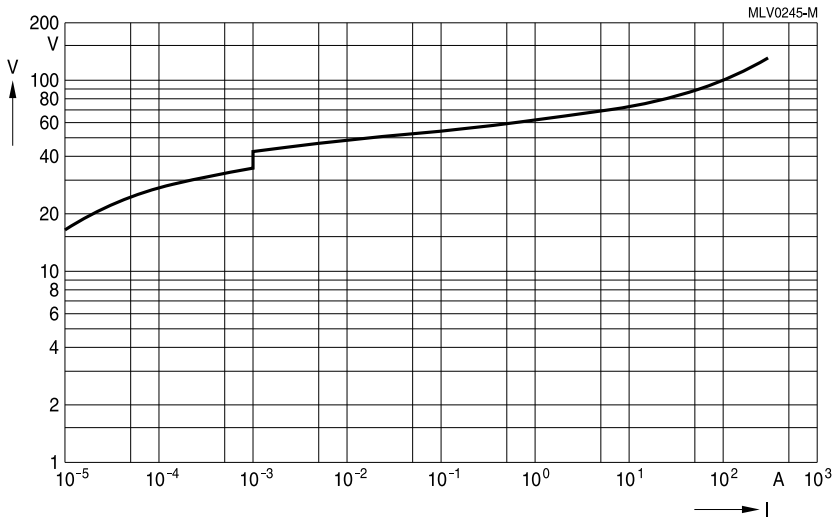

**CT1210K25G**

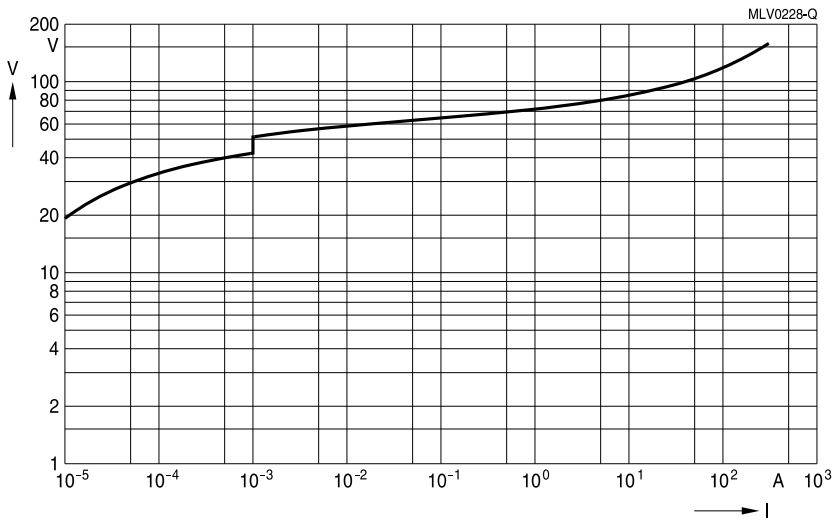

**CT1210K30G**

## Multilayer varistors (MLVs)

### Automotive series

### SMD

#### Derating curves

Maximum surge current  $I_{\text{surge,max}} = f(t_r, \text{pulse train})$

For explanation of the derating curves refer to "General technical information", chapter 2.7.2

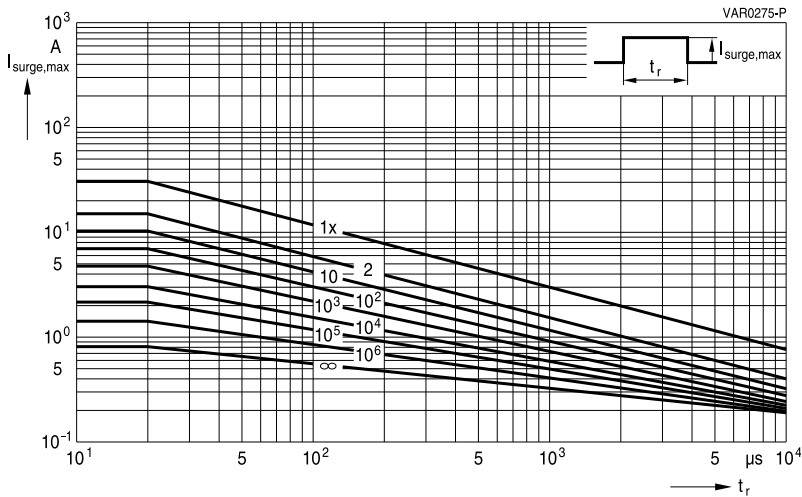

CN0603 ... HTG (G2, G5), CT0603K14 ... K25G, CT0603S14B(AUTO)G, CT0603K17CCG, CT0603S17ALCG, CT0603S17BCCG, CT0603S20ACCG, CT0805K17(AUTO)LCG

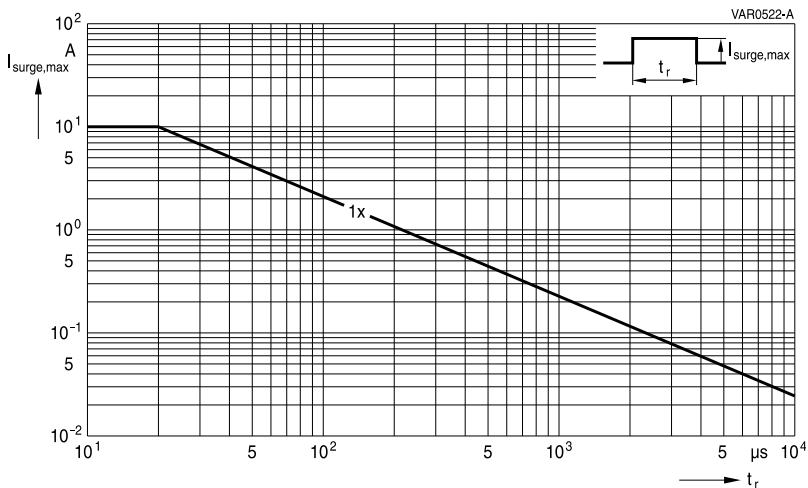

CT0603K17LCG

## Multilayer varistors (MLVs)

### Automotive series

### SMD

#### Derating curves

Maximum surge current  $I_{\text{surge,max}} = f(t_r, \text{pulse train})$

For explanation of the derating curves refer to "General technical information", chapter 2.7.2

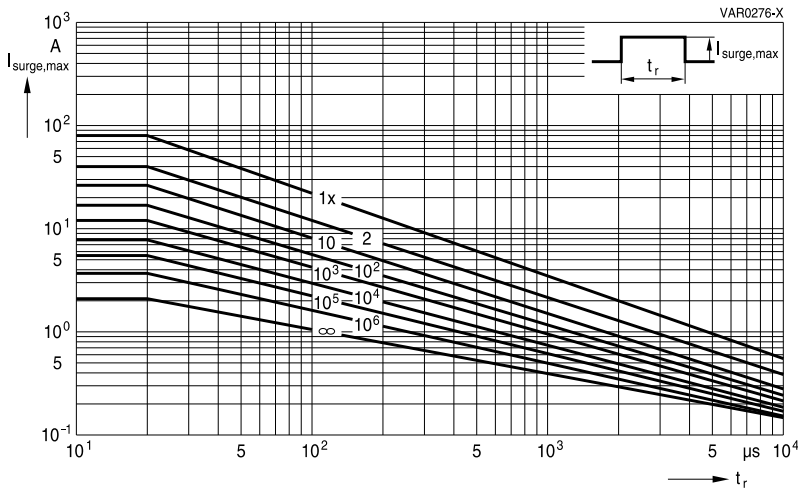

CT0805K20 ... K30G, CT0805S20ACC2G2, CT0805K25AUTOG, CT0805K25CCG

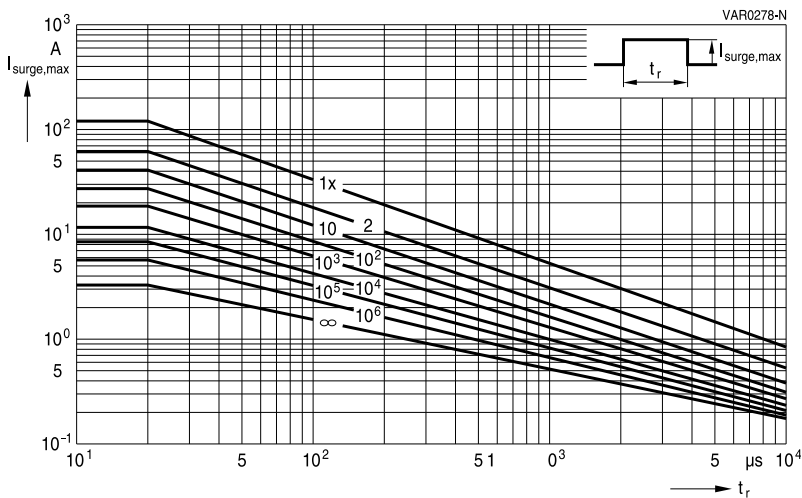

CT0805S14BAUTOG, CT0805K14 ... K17G

**Multilayer varistors (MLVs)**

**Automotive series**

**SMD**

**Derating curves**

Maximum surge current  $I_{\text{surge,max}} = f(t_r, \text{pulse train})$

For explanation of the derating curves refer to "General technical information", chapter 2.7.2

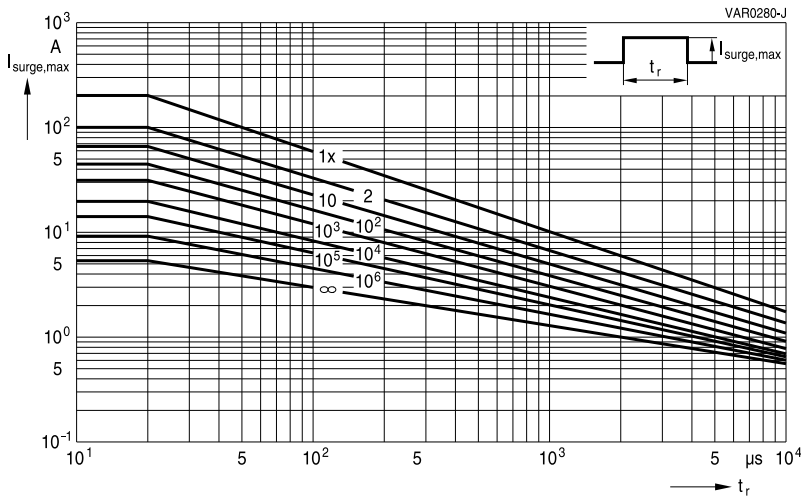

**CT1206 ... (AUTO)G**

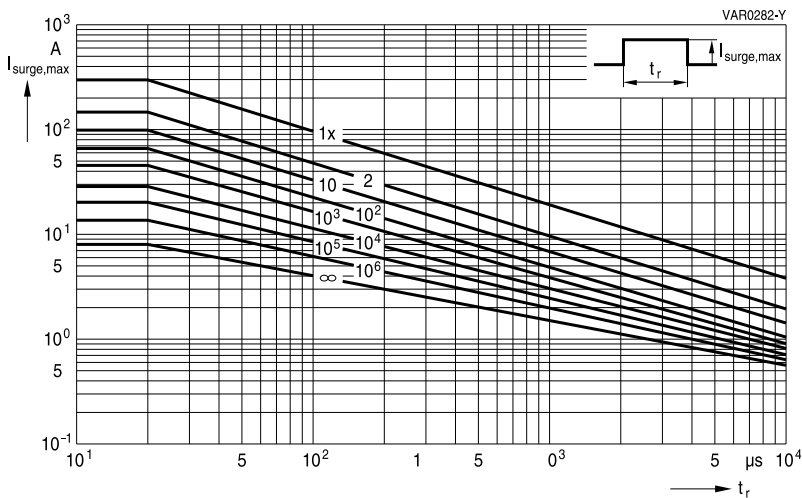

**CT1210K25(AUTO)G, CT1210K30G**

## Multilayer varistors (MLVs)

### Automotive series

### SMD

#### Derating curves

Maximum surge current  $I_{\text{surge,max}} = f(t_r, \text{pulse train})$

For explanation of the derating curves refer to "General technical information", chapter 2.7.2

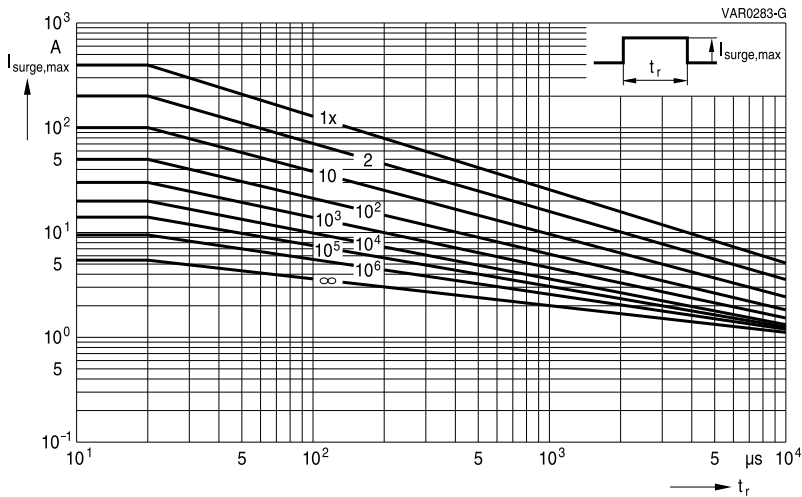

CT1210K14 ... K20G, CT1210S14BAUTOG, CT1210K17AUTOG, CN1210K17AUTOHTG, CT1210K20AUTOG, CT1210K25AUTOG

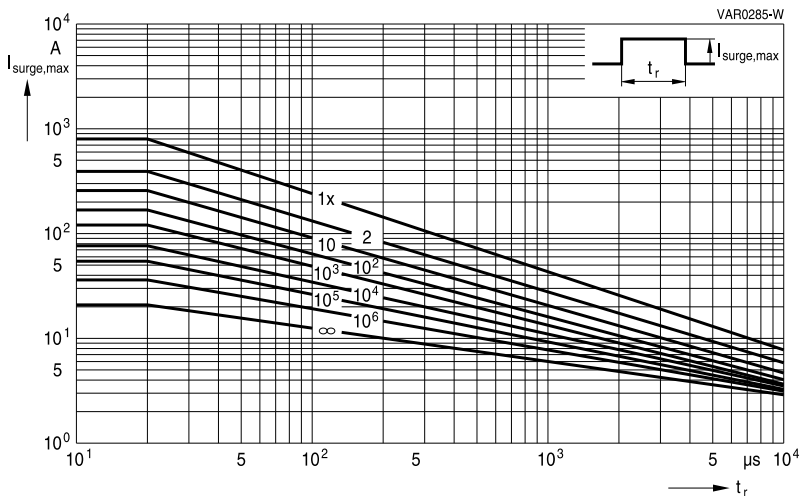

CN1812K14 ... K30G(K2),  
CN1812S14BAUTO(E2)G(2)(K2)



Multilayer varistors (MLVs)

Automotive series

SMD

Derating curves

Maximum surge current  $I_{\text{surge,max}} = f(t_r, \text{pulse train})$

For explanation of the derating curves refer to "General technical information", chapter 2.7.2

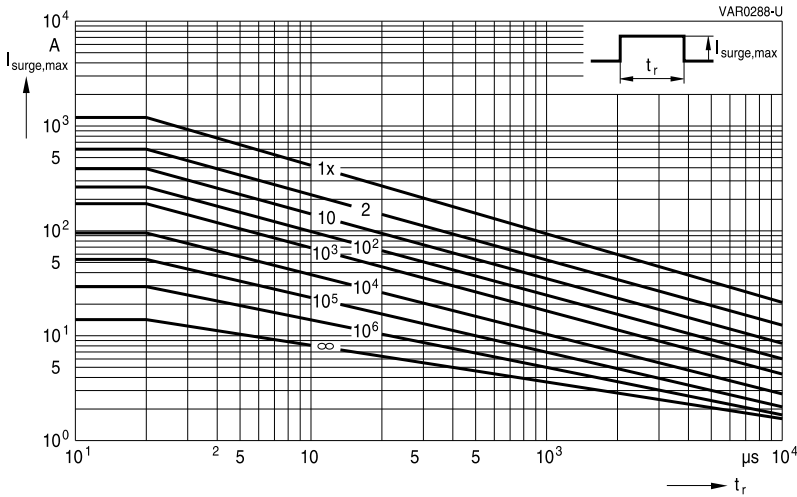

CN2220K14 ... K30G(K2), CN2220 ... AUTO(E2)G(2)(K2)

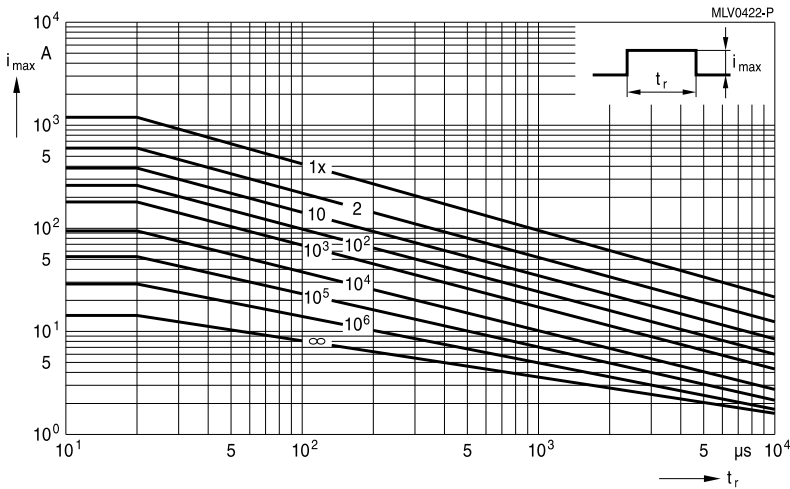

CN2220S14EAUTOE2G2K2

## Multilayer varistors (MLVs)

### Automotive series

### SMD

#### Taping and packing

#### 1 Taping and packing for SMD components

#### 1.1 Blister tape (the taping to IEC 60286-3)

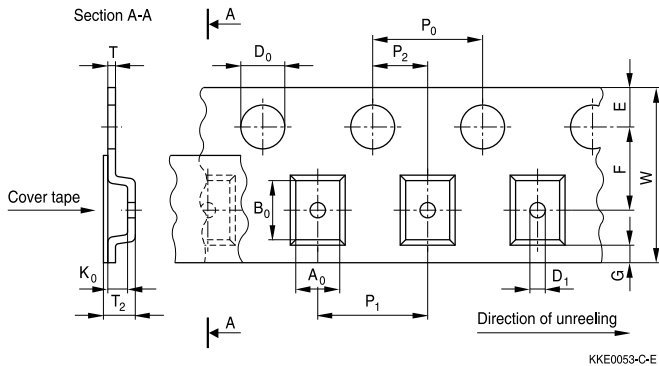

KKE0063-C-E

#### Dimensions in mm

	8-mm tape					12-mm tape		16-mm tape		Tolerance
	Case size (inch/mm)					Case size (inch/mm)		Case size (inch/mm)		
			0508/ 1220	0612/ 1632	1012/ 2532					
	0603/ 1608	0506/ 1216	0805/ 2012	1206/ 3216	1210/ 3225	1812/ 4532	2220/ 5750	3225	4032	
A <sub>0</sub>	0.9 ±0.10	1.50	1.60	1.90	2.80	3.50	5.10	7.00	8.60	±0.20
B <sub>0</sub>	1.75 ±0.10	1.80	2.40	3.50	3.50	4.80	6.00	8.70	10.60	±0.20
K <sub>0</sub>	1.0	0.80	1.80			2.60		5.00		max.
T	0.30					0.30		0.30		max.
T <sub>2</sub>	1.3	1.20	2.50			3.50		5.50		max.
D <sub>0</sub>	1.50					1.50		1.50		+0.10/-0
D <sub>1</sub>	1.00					1.50		1.50		min.
P <sub>0</sub>	4.00					4.00		4.00		±0.10 <sup>1)</sup>
P <sub>2</sub>	2.00					2.00		2.00		±0.05
P <sub>1</sub>	4.00					8.00		12.00		±0.10
W	8.00					12.00		16.00		±0.30
E	1.75					1.75		1.75		±0.10
F	3.50					5.50		7.50		±0.05
G	0.75					0.75		0.75		min.

1) ≤±0.2 mm over 10 sprocket holes.

## Multilayer varistors (MLVs)

### Automotive series

### SMD

#### Part orientation in tape pocket for blister tape

For discrete chip, case sizes 0603, 0805, 1206, 1210, 1812 and 2220

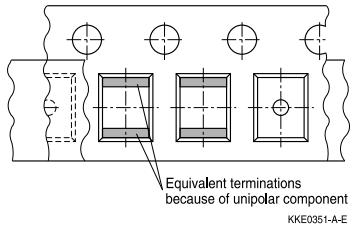

For array, case sizes 0612

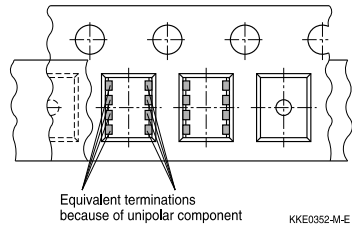

For arrays 0506 and 1012

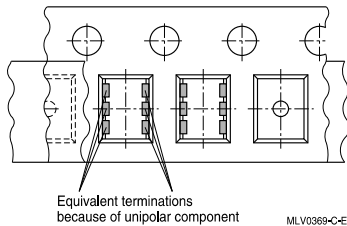

For filter array, case size 0508

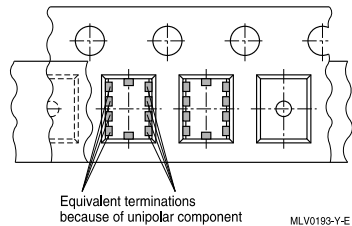

#### Additional taping information

Reel material	Polystyrol (PS)
Tape material	Polystyrol (PS) or Polycarbonat (PC) or PVC
Tape break force	min. 10 N
Top cover tape strength	min. 10 N
Top cover tape peel force	0.2 to 0.6 N for 8-mm tape and 0.2 to 0.8 N for 12-mm tape at a peel speed of 300 mm/min
Tape peel angle	Angle between top cover tape and the direction of feed during peel off: 165° to 180°
Cavity play	Each part rests in the cavity so that the angle between the part and cavity center line is no more than 20°

**Multilayer varistors (MLVs)**

**Automotive series**

**SMD**

**1.2 Cardboard tape (taping to IEC 60286-3)**

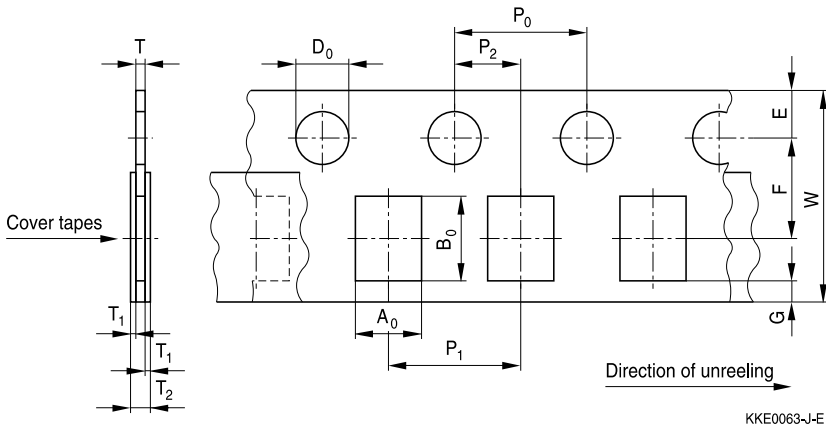

**Dimensions in mm**

	8-mm tape						Tolerance
	Case size (inch/mm)					Case size (inch/mm)	
	0201/0603	0402/1005	0405/1012	0603/1608	1003/2508	0508/1220	
A <sub>0</sub>	0.38 ±0.05	0.60	1.05	0.95	1.00	1.60	±0.20
B <sub>0</sub>	0.68 ±0.05	1.15	1.60	1.80	2.85	2.40	±0.20
T	0.35 ±0.02	0.60	0.75	0.95	1.00	0.95	max.
T <sub>2</sub>	0.4 min.	0.70	0.90	1.10	1.10	1.12	max.
D <sub>0</sub>	1.50 ±0.1	1.50				1.50	+0.10/-0
P <sub>0</sub>	4.00						±0.10 <sup>2)</sup>
P <sub>2</sub>	2.00						±0.05
P <sub>1</sub>	2.00 ±0.05	2.00	4.00	4.00	4.00	4.00	±0.10
W	8.00						±0.30
E	1.75						±0.10
F	3.50						±0.05
G	1.35	0.75					min.

2) ≤0.2 mm over 10 sprocket holes.

## Multilayer varistors (MLVs)

### Automotive series

#### SMD

#### Part orientation in tape pocket for cardboard tape

For discrete chip case sizes 0201, 0402, 0603 and 1003

For array case size 0405

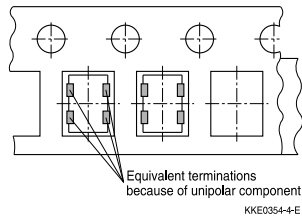
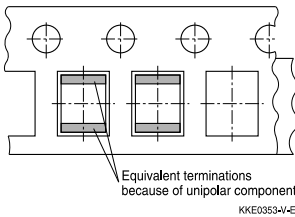

For array case size 0508

For filter array, case size 0405

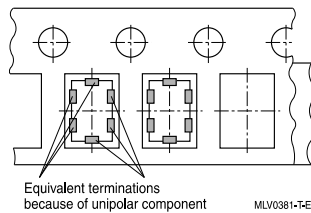
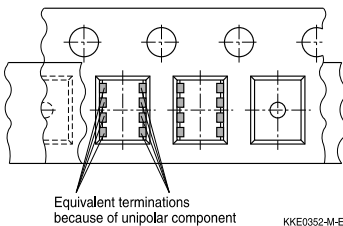

#### Additional taping information

Reel material	Polystyrol (PS)
Tape material	Cardboard
Tape break force	min. 10 N
Top cover tape strength	min. 10 N
Top cover tape peel force	0.1 to 0.65 N at a peel speed of 300 mm/min
Tape peel angle	Angle between top cover tape and the direction of feed during peel off: 165° to 180°
Cavity play	Each part rests in the cavity so that the angle between the part and cavity center line is no more than 20°

**Multilayer varistors (MLVs)**

**Automotive series**

**SMD**

**1.3 Reel packing**

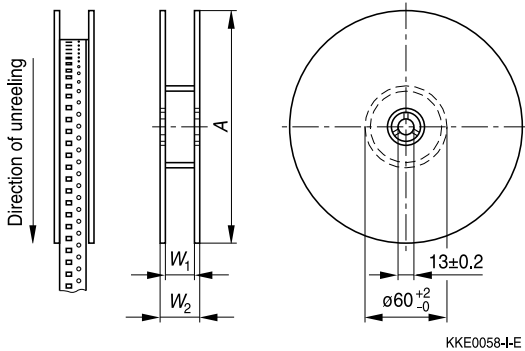

**Dimensions in mm**

	8-mm tape		12-mm tape		16-mm tape
	180-mm reel	330-mm reel	180-mm reel	330-mm reel	330-mm reel
A	180 -3/+0	330 -2.0	180 -3/+0	330 -2.0	330 -2.0
W <sub>1</sub>	8.4 +1.5/-0	8.4 +1.5/-0	12.4 +1.5/-0	12.4 +1.5/-0	16.4 +1.5/-0
W <sub>2</sub>	14.4 max.	14.4 max.	18.4 max.	18.4 max.	22.4 max.

**Leader, trailer**

Tape end (Trailer)

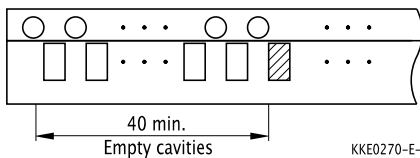

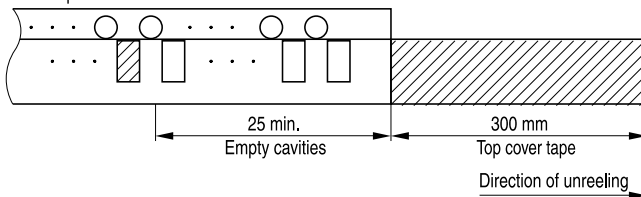

Leader part

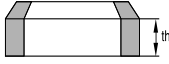
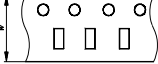

KKE0289-Q-E

**Multilayer varistors (MLVs)**
**Automotive series**
**SMD**
**1.4 Packing units for discrete chip and array chip**

Case size inch/mm	 Chip thickness th				
		Cardboard tape W	Blister tape W	∅ 180-mm reel pcs.	∅ 330-mm reel pcs.
0201/0603	0.33 mm	8 mm	–	15000	–
0402/1005	0.6 mm	8 mm	–	10000	–
0405/1012	0.7 mm	8 mm	–	5000	–
0506/1216	0.5 mm	–	8 mm	4000	–
0508/1220	0.9 mm	8 mm	8 mm	4000	–
0603/1608	0.9 mm	8 mm	8 mm	4000	16000
0612/1632	0.9 mm	–	8 mm	3000	–
0805/2012	0.7 mm	–	8 mm	3000	–
	0.9 mm	–	8 mm	3000	12000
	1.3 mm	–	8 mm	3000	–
1003/2508	0.9 mm	8 mm	–	4000	–
1012/2532	1.0 mm	–	8 mm	2000	–
1206/3216	0.9 mm	–	8 mm	3000	–
	1.3 mm	–	8 mm	3000	–
	1.4 mm	–	8 mm	2000	–
	1.6 mm	–	8 mm	2000	–
1210/3225	0.9 mm	–	8 mm	3000	–
	1.3 mm	–	8 mm	3000	–
	1.4 mm	–	8 mm	2000	–
	1.6 mm	–	8 mm	2000	–
1812/4532	1.3 mm	–	12 mm	1500	–
	1.4 mm	–	12 mm	1000	–
	1.6 mm	–	12 mm	–	4000
	2.3 mm	–	12 mm	–	3000
2220/5750	1.3 mm	–	12 mm	1500	–
	1.4 mm	–	12 mm	1000	–
	2.0 mm	–	12 mm	–	3000
	2.3 mm	–	12 mm	–	3000
3225	3.2 mm	–	16 mm	–	1000
	4.5 mm	–	16 mm	–	1000
4032	3.2 mm	–	16 mm	–	1000
	4.5 mm	–	16 mm	–	1000

**Multilayer varistors (MLVs)****Automotive series****SMD****2 Delivery mode for leaded SHCV varistors**

Standard delivery mode for SHCV types is bulk. Alternative taping modes (AMMO pack or taped on reel) are available upon request.

Packing units for:

Type	Pieces
SR6	2000
SR1 / SR2	1000

For types not listed in this data book please contact EPCOS.



## Multilayer varistors (MLVs)

### Automotive series

### SMD

#### Soldering directions

#### 1 Terminations

##### 1.1 Nickel barrier termination

The nickel barrier layer of the silver/nickel/tin termination prevents leaching of the silver base metallization layer. This allows great flexibility in the selection of soldering parameters. The tin prevents the nickel layer from oxidizing and thus ensures better wetting by the solder. The nickel barrier termination is suitable for all commonly-used soldering methods.

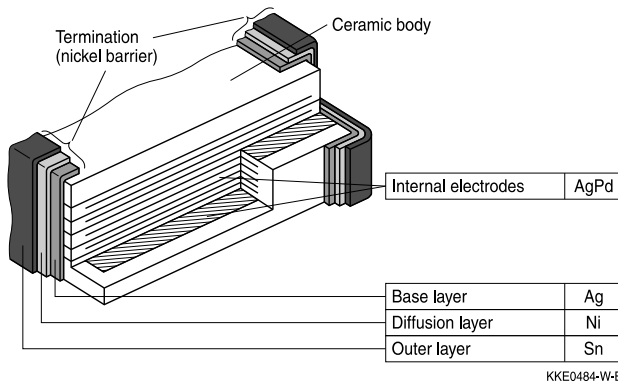

Multilayer CTVS: Structure of nickel barrier termination

##### 1.2 Silver-palladium termination

Silver-palladium terminations are used for the large case sizes 1812 and 2220 and for chips intended for conductive adhesion. This metallization improves the resistance of large chips to thermal shock.

In case of conductive adhesion, the silver-palladium metallization reduces susceptibility to corrosion. Silver-palladium termination can be used for smaller case sizes (only chip) for hybrid applications as well. The silver-palladium termination is not approved for lead-free soldering.

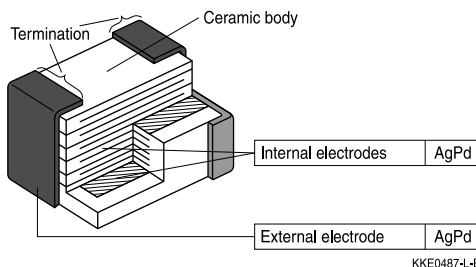

Multilayer varistor: Structure of silver-palladium termination

## Multilayer varistors (MLVs)

### Automotive series

#### SMD

### 1.3 Silver-platinum termination

Silver-platinum terminations are mainly used for the large case sizes 1812 and 2220. The silver-platinum termination is approved for reflow soldering, SnPb soldering and lead-free soldering with a silver containing solder paste. In case of SnPb soldering, a solder paste Sn62Pb36Ag2 is recommended. For lead-free reflow soldering, a solder paste SAC, e.g. Sn95.5Ag3.8Cu0.7, is recommended.

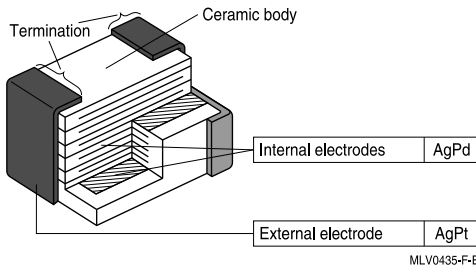

Multilayer varistor: Structure of silver-platinum termination

## 2 Recommended soldering temperature profiles

### 2.1 Reflow soldering temperature profile

#### Recommended temperature characteristic for reflow soldering following JEDEC J-STD-020D

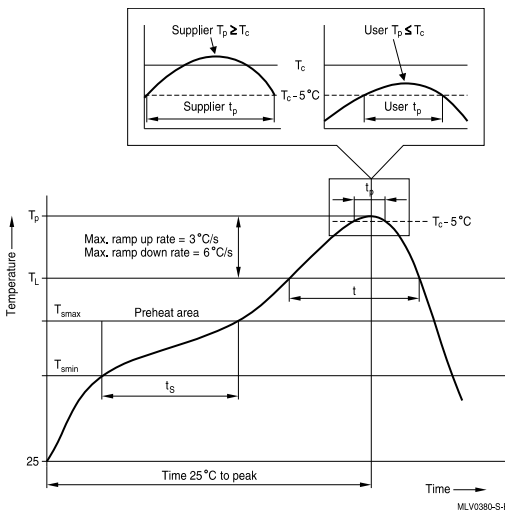

## Multilayer varistors (MLVs)

### Automotive series

### SMD

Profile feature		Sn-Pb eutectic assembly	Pb-free assembly
Preheat and soak			
- Temperature min	$T_{smin}$	100 °C	150 °C
- Temperature max	$T_{smax}$	150 °C	200 °C
- Time	$t_{smin}$ to $t_{smax}$	60 ... 120 s	60 ... 180 s
Average ramp-up rate	$T_{smax}$ to $T_p$	3 °C/ s max.	3 °C/ s max.
Liquidous temperature	$T_L$	183 °C	217 °C
Time at liquidous	$t_L$	60 ... 150 s	60 ... 150 s
Peak package body temperature	$T_p$ <sup>1)</sup>	220 °C ... 235 °C <sup>2)</sup>	245 °C ... 260 °C <sup>2)</sup>
Time ( $t_p$ ) <sup>3)</sup> within 5 °C of specified classification temperature ( $T_c$ )		20 s <sup>3)</sup>	30 s <sup>3)</sup>
Average ramp-down rate	$T_p$ to $T_{smax}$	6 °C/ s max.	6 °C/ s max.
Time 25 °C to peak temperature		maximum 6 min	maximum 8 min

1) Tolerance for peak profile temperature ( $T_p$ ) is defined as a supplier minimum and a user maximum.

2) Depending on package thickness. For details please refer to JEDEC J-STD-020D.

3) Tolerance for time at peak profile temperature ( $t_p$ ) is defined as a supplier minimum and a user maximum.

**Note:** All temperatures refer to topside of the package, measured on the package body surface.  
Number of reflow cycles: 3

## 2.2 Wave soldering temperature profile

Temperature characteristics at component terminal with dual-wave soldering

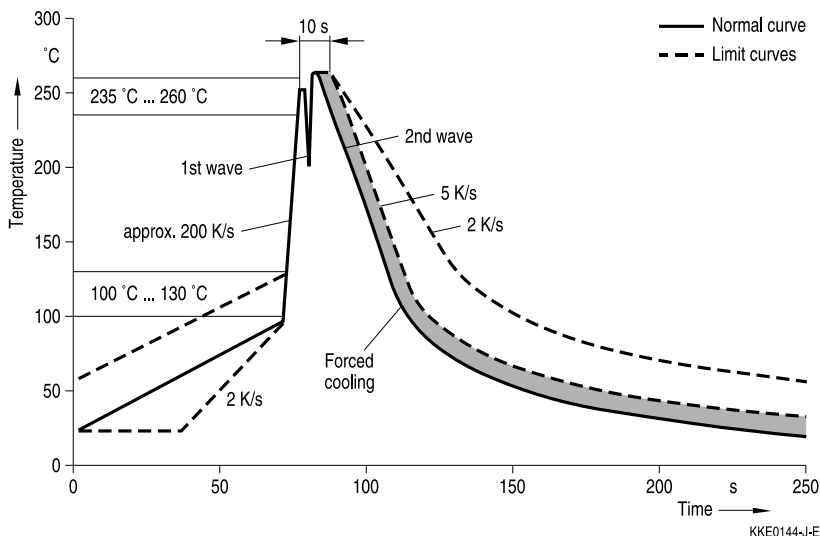

## Multilayer varistors (MLVs)

### Automotive series

#### SMD

### 2.3 Lead-free soldering processes

EPCOS multilayer CTVS with AgNiSn termination are designed for the requirements of lead-free soldering processes only.

Soldering temperature profiles to JEDEC J-STD-020D, IEC 60068-2-58 and ZVEI recommendations.

## 3 Recommended soldering methods - type-specific releases by EPCOS

### 3.1 Overview

Type	Case size	Reflow soldering		Wave soldering	
		SnPb	Lead-free	SnPb	Lead-free
CT... / CD...	0201/ 0402	Approved	Approved	No	No
CT... / CD...	0603 ... 2220	Approved	Approved	Approved	Approved
CN...	0603 ... 2220	Approved	No	Approved	No
CN...K2	1812, 2220	Approved	Approved	No	No
Arrays	0405 ... 1012	Approved	Approved	No	No
ESD/EMI filters	0405, 0508	Approved	Approved	No	No
CU	3225, 4032	Approved	Approved	Approved	Approved
SHCV	-	No	No	Approved	Approved

### 3.2 Nickel barrier and AgPt terminated multilayer CTVS

All EPCOS MLVs with nickel barrier and AgPt termination are suitable and fully qualified for lead-free soldering. The nickel barrier layer is 100% matte tin-plated.

### 3.3 Silver-palladium terminated MLVs

AgPd-terminated MLVs are mainly designed for conductive adhesion technology on hybrid material. Additionally MLVs with AgPd termination are suitable for reflow and wave soldering with SnPb solder.

#### **Note:**

Lead-free soldering is not approved for MLVs with AgPd termination.

### 3.4 Silver-platinum terminated MLVs

The silver-platinum termination is approved for reflow soldering, SnPb soldering and lead-free with a silver containing solder paste. In case of SnPb soldering, a solder paste Sn62Pb36Ag2 is recommended. For lead-free reflow soldering, a solder paste SAC, e.g. Sn95.5Ag3.8Cu0.7, is recommended.

**Multilayer varistors (MLVs)**

**Automotive series**

**SMD**

**3.5 Tinned copper alloy**

All EPCOS CU types with tinned termination are approved for lead-free and SnPb soldering.

**3.6 Tinned iron wire**

All EPCOS SHCV types with tinned termination are approved for lead-free and SnPb soldering.

**4 Solder joint profiles / solder quantity**

**4.1 Nickel barrier termination**

If the meniscus height is too low, that means the solder quantity is too low, the solder joint may break, i.e. the component becomes detached from the joint. This problem is sometimes interpreted as leaching of the external terminations.

If the solder meniscus is too high, i.e. the solder quantity is too large, the vise effect may occur. As the solder cools down, the solder contracts in the direction of the component. If there is too much solder on the component, it has no leeway to evade the stress and may break, as in a vise.

The figures below show good and poor solder joints for dual-wave and infrared soldering.

**4.1.1 Solder joint profiles for nickel barrier termination - dual-wave soldering**

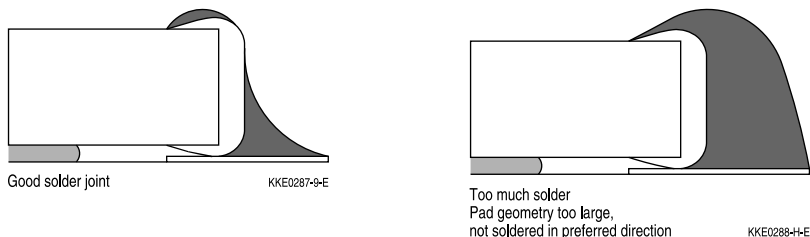

Good and poor solder joints caused by amount of solder in dual-wave soldering.

**4.1.2 Solder joint profiles for nickel barrier termination / silver-palladium / silver-platinum termination - reflow soldering**

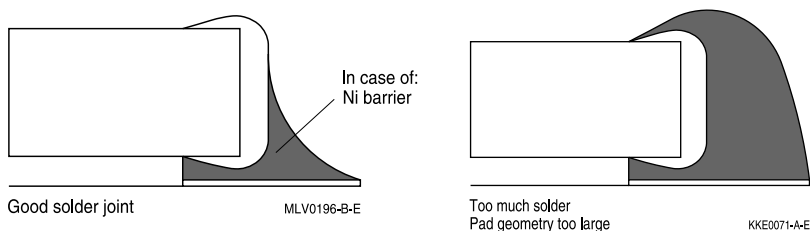

## Multilayer varistors (MLVs)

### Automotive series

#### SMD

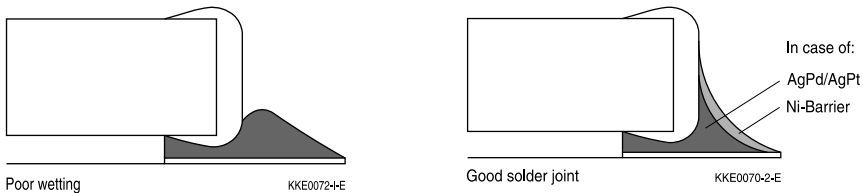

Good and poor solder joints caused by amount of solder in reflow soldering.

## 5 Conductive adhesion

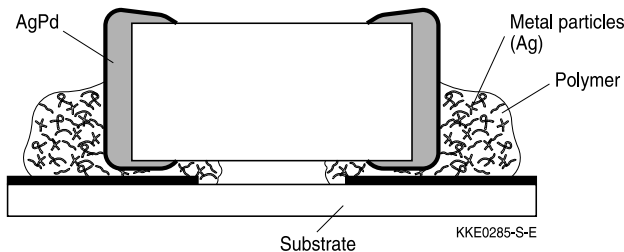

Attaching surface-mounted devices (SMDs) with electrically conductive adhesives is a commercially attractive method of component connection to supplement or even replace conventional soldering methods.

Electrically conductive adhesives consist of a non-conductive plastic (epoxy resin, polyimide or silicon) in which electrically conductive metal particles (gold, silver, palladium, nickel, etc) are embedded. Electrical conduction is effected by contact between the metal particles.

Adhesion is particularly suitable for meeting the demands of hybrid technology. The adhesives can be deposited ready for production requirements by screen printing, stamping or by dispensers. As shown in the following table, conductive adhesion involves two work operations fewer than soldering.

Reflow soldering	Wave soldering	Conductive adhesion
Screen-print solder paste	Apply glue dot	Screen-print conductive adhesive
Mount SMD	Mount SMD	Mount SMD
Predry solder paste	Cure glue	Cure adhesive
Reflow soldering	Wave soldering	Inspect
Wash	Wash	
Inspect	Inspect	

## Multilayer varistors (MLVs)

### Automotive series

#### SMD

A further advantage of adhesion is that the components are subjected to virtually no temperature shock at all. The curing temperatures of the adhesives are between 120 °C and 180 °C, typical curing times are between 30 minutes and one hour.

The bending strength of glued chips is, in comparison with that of soldered chips, higher by a factor of at least 2, as is to be expected due to the elasticity of the glued joints.

The lower conductivity of conductive adhesive may lead to higher contact resistance and thus result in electrical data different to those of soldered components. Users must pay special attention to this in RF applications.

### 6 Solderability tests

Test	Standard	Test conditions Sn-Pb soldering	Test conditions Pb-free soldering	Criteria/ test results
Wettability	IEC 60068-2-58	Immersion in 60/40 SnPb solder using non-activated flux at $215 \pm 3$ °C for $3 \pm 0.3$ s	Immersion in Sn96.5Ag3.0Cu0.5 solder using non- or low activated flux at $245 \pm 5$ °C for $3 \pm 0.3$ s	Covering of 95% of end termination, checked by visual inspection
Leaching resistance	IEC 60068-2-58	Immersion in 60/40 SnPb solder using mildly activated flux without preheating at $260 \pm 5$ °C for $10 \pm 1$ s	Immersion in Sn96.5Ag3.0Cu0.5 solder using non- or low activated flux without preheating at $255 \pm 5$ °C for $10 \pm 1$ s	No leaching of contacts
Thermal shock (solder shock)		Dip soldering at $300$ °C/5 s	Dip soldering at $300$ °C/5 s	No deterioration of electrical parameters. Capacitance change: $\leq \pm 15\%$
Tests of resistance to soldering heat for SMDs	IEC 60068-2-58	Immersion in 60/40 SnPb for 10 s at $260$ °C	Immersion in Sn96.5Ag3.0Cu0.5 for 10 s at $260$ °C	Change of varistor voltage: $\leq \pm 5\%$
Tests of resistance to soldering heat for radial leaded components (SHCV)	IEC 60068-2-20	Immersion of leads in 60/40 SnPb for 10 s at $260$ °C	Immersion of leads in Sn96.5Ag3.0Cu0.5 for 10 s at $260$ °C	Change of varistor voltage: $\leq \pm 5\%$ Change of capacitance X7R: $\leq -5/+10\%$

## Multilayer varistors (MLVs)

### Automotive series

#### SMD

#### Note:

#### Leaching of the termination

Effective area at the termination might be lost if the soldering temperature and/or immersion time are not kept within the recommended conditions. Leaching of the outer electrode should not exceed 25% of the chip end area (full length of the edge A-B-C-D) and 25% of the length A-B, shown below as mounted on substrate.

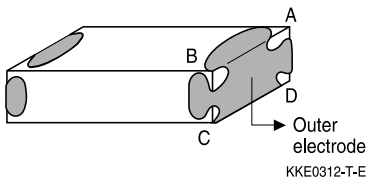

As a single chip

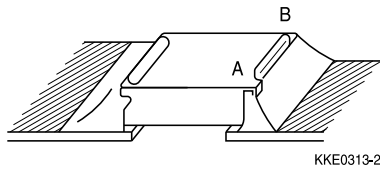

As mounted on substrate

## 7 Notes for proper soldering

### 7.1 Preheating and cooling

- According to JEDEC J-STD-020D. Please refer to chapter 2.

### 7.2 Repair / rework

Manual soldering with a soldering iron must be avoided, hot-air methods are recommended for rework purposes.

### 7.3 Cleaning

All environmentally compatible agents are suitable for cleaning. Select the appropriate cleaning solution according to the type of flux used. The temperature difference between the components and cleaning liquid must not be greater than 100 °C. Ultrasonic cleaning should be carried out with the utmost caution. Too high ultrasonic power can impair the adhesive strength of the metalized surfaces.

### 7.4 Solder paste printing (reflow soldering)

An excessive application of solder paste results in too high a solder fillet, thus making the chip more susceptible to mechanical and thermal stress. Too little solder paste reduces the adhesive strength on the outer electrodes and thus weakens the bonding to the PCB. The solder should be applied smoothly to the end surface.



## Multilayer varistors (MLVs)

### Automotive series

#### SMD

#### 7.5 Adhesive application

Thin or insufficient adhesive causes chips to loosen or become disconnected during curing. Low viscosity of the adhesive causes chips to slip after mounting. It is advised to consult the manufacturer of the adhesive on proper usage and amounts of adhesive to use.

#### 7.6 Selection of flux

Used flux should have less than or equal to 0.1 wt % of halogenated content, since flux residue after soldering could lead to corrosion of the termination and/or increased leakage current on the surface of the component. Strong acidic flux must not be used. The amount of flux applied should be carefully controlled, since an excess may generate flux gas, which in turn is detrimental to solderability.

#### 7.7 Storage of CTVs

Solderability is guaranteed for one year from date of delivery for multilayer varistors, CeraDiodes and ESD/EMI filters (half a year for chips with AgPd and AgPt terminations) and two years for SHCV and CU components, provided that components are stored in their original packages.

Storage temperature:  $-25\text{ }^{\circ}\text{C}$  to  $+45\text{ }^{\circ}\text{C}$

Relative humidity:  $\leq 75\%$  annual average,  $\leq 95\%$  on 30 days a year

The solderability of the external electrodes may deteriorate if SMDs and leaded components are stored where they are exposed to high humidity, dust or harmful gas (hydrogen chloride, sulfurous acid gas or hydrogen sulfide).

Do not store SMDs and leaded components where they are exposed to heat or direct sunlight. Otherwise the packing material may be deformed or SMDs/ leaded components may stick together, causing problems during mounting.

After opening the factory seals, such as polyvinyl-sealed packages, it is recommended to use the SMDs or leaded components as soon as possible.

#### 7.8 Placement of components on circuit board

Especially in the case of dual-wave soldering, it is of advantage to place the components on the board before soldering in that way that their two terminals do not enter the solder bath at different times.

Ideally, both terminals should be wetted simultaneously.

#### 7.9 Soldering cautions

- An excessively long soldering time or high soldering temperature results in leaching of the outer electrodes, causing poor adhesion and a change of electrical properties of the varistor due to the loss of contact between electrodes and termination.
- Wave soldering must not be applied for MLVs designated for reflow soldering only.
- Keep the recommended down-cooling rate.

## Multilayer varistors (MLVs)

### Automotive series

#### SMD

#### 7.10 Standards

CECC 00802

IEC 60068-2-58

IEC 60068-2-20

JEDEC J-STD-020D

## Multilayer varistors (MLVs)

### Automotive series

### SMD

#### Symbols and terms

Symbol	Term
$C_{line,typ}$	Typical capacitance per line
$C_{max}$	Maximum capacitance
$C_{min}$	Minimum capacitance
$C_{nom}$	Nominal capacitance
$\Delta C_{nom}$	Tolerance of nominal capacitance
$C_{typ}$	Typical capacitance
$f_{cut-off,min}$	Minimum cut-off frequency
$I$	Current
$I_{clamp}$	Clamping current
$I_{leak}$	Leakage current
$I_{leak,typ}$	Typical leakage current
$I_{PP}$	Peak pulse current
$I_{surge,max}$	Maximum surge current (also termed peak current)
LCT	Lower category temperature
$L_{typ}$	Typical inductance
$P_{diss,max}$	Maximum power dissipation
$P_{PP}$	Peak pulse power
$R_{ins}$	Insulation resistance
$R_{min}$	Minimum resistance
$R_S$	Resistance per line
$T_A$	Ambient temperature
$T_{op}$	Operating temperature
$T_{stg}$	Storage temperature
$t_r$	Duration of equivalent rectangular wave
$t_{resp}$	Response time
UCT	Upper category temperature
$V$	Voltage
$V_{BR,min}$	Minimum breakdown voltage
$V_{clamp,max}$	Maximum clamping voltage
$V_{DC,max}$	Maximum DC operating voltage (also termed working voltage)
$V_{ESD,air}$	Air discharge ESD capability
$V_{ESD,contact}$	Contact discharge ESD capability
$V_{jump}$	Maximum jump start voltage

## Multilayer varistors (MLVs)

### Automotive series

#### SMD

$V_{\text{RMS,max}}$	Maximum AC operating voltage, root-mean-square value
$V_V$	Varistor voltage (also termed breakdown voltage)
$V_{V,\text{min}}$	Minimum varistor voltage
$V_{V,\text{max}}$	Maximum varistor voltage
$\Delta V_V$	Tolerance of varistor voltage
$W_{\text{LD}}$	Maximum load dump
$W_{\text{max}}$	Maximum energy absorption (also termed transient energy)
$\alpha_{\text{typ}}$	Typical insertion loss
$e$	Lead spacing
$\ll * \gg$	Maximum possible application conditions

All dimensions are given in mm.

The commas used in numerical values denote decimal points.

## Multilayer varistors (MLVs)

### Automotive series

#### SMD

### Cautions and warnings

#### General

Some parts of this publication contain statements about the suitability of our ceramic transient voltage suppressor (CTVS) components (multilayer varistors (MLVs), CeraDiodes, ESD/EMI filters, SMD disk varistors (CU types), leaded transient voltage/ RFI suppressors (SHCV types)) for certain areas of application, including recommendations about incorporation/design-in of these products into customer applications. The statements are based on our knowledge of typical requirements often made of our CTVS devices in the particular areas. We nevertheless expressly point out that such statements cannot be regarded as binding statements about the suitability of our CTVS components for a particular customer application. As a rule, EPCOS is either unfamiliar with individual customer applications or less familiar with them than the customers themselves. For these reasons, it is always incumbent on the customer to check and decide whether the CTVS devices with the properties described in the product specification are suitable for use in a particular customer application.

- Do not use EPCOS CTVS components for purposes not identified in our specifications, application notes and data books.
- Ensure the suitability of a CTVS in particular by testing it for reliability during design-in. Always evaluate a CTVS component under worst-case conditions.
- Pay special attention to the reliability of CTVS devices intended for use in safety-critical applications (e.g. medical equipment, automotive, spacecraft, nuclear power plant).

#### Design notes

- Always connect a CTVS in parallel with the electronic circuit to be protected.
- Consider maximum rated power dissipation if a CTVS has insufficient time to cool down between a number of pulses occurring within a specified isolated time period. Ensure that electrical characteristics do not degrade.
- Consider derating at higher operating temperatures. Choose the highest voltage class compatible with derating at higher temperatures.
- Surge currents beyond specified values will puncture a CTVS. In extreme cases a CTVS will burst.
- If steep surge current edges are to be expected, make sure your design is as low-inductance as possible.
- In some cases the malfunctioning of passive electronic components or failure before the end of their service life cannot be completely ruled out in the current state of the art, even if they are operated as specified. In applications requiring a very high level of operational safety and especially when the malfunction or failure of a passive electronic component could endanger human life or health (e.g. in accident prevention, life-saving systems, or automotive battery line applications such as clamp 30), ensure by suitable design of the application or other measures (e.g. installation of protective circuitry or redundancy) that no injury or damage is sustained by third parties in the event of such a malfunction or failure. Only use CTVS components from the automotive series in safety-relevant applications.

## Multilayer varistors (MLVs)

### Automotive series

#### SMD

- Specified values only apply to CTVS components that have not been subject to prior electrical, mechanical or thermal damage. The use of CTVS devices in line-to-ground applications is therefore not advisable, and it is only allowed together with safety countermeasures like thermal fuses.

#### Storage

- Only store CTVS in their original packaging. Do not open the package before storage.
- Storage conditions in original packaging: temperature  $-25$  to  $+45^{\circ}\text{C}$ , relative humidity  $\leq 75\%$  annual average, maximum 95%, dew precipitation is inadmissible.
- Do not store CTVS devices where they are exposed to heat or direct sunlight. Otherwise the packaging material may be deformed or CTVS may stick together, causing problems during mounting.
- Avoid contamination of the CTVS surface during storage, handling and processing.
- Avoid storing CTVS devices in harmful environments where they are exposed to corrosive gases for example ( $\text{SO}_x$ , Cl).
- Use CTVS as soon as possible after opening factory seals such as polyvinyl-sealed packages.
- Solder CTVS components after shipment from EPCOS within the time specified:
  - CTVS with Ni barrier termination, 12 months
  - CTVS with AgPd and AgPt termination, 6 months
  - SHCV and CU series, 24 months

#### Handling

- Do not drop CTVS components and allow them to be chipped.
- Do not touch CTVS with your bare hands - gloves are recommended.
- Avoid contamination of the CTVS surface during handling.

#### Mounting

- When CTVS devices are encapsulated with sealing material or overmolded with plastic material, electrical characteristics might be degraded and the life time reduced.
- Make sure an electrode is not scratched before, during or after the mounting process.
- Make sure contacts and housings used for assembly with CTVS components are clean before mounting.
- The surface temperature of an operating CTVS can be higher. Ensure that adjacent components are placed at a sufficient distance from a CTVS to allow proper cooling.
- Avoid contamination of the CTVS surface during processing.
- Multilayer varistors (MLVs) with AgPd termination are not approved for lead-free soldering.

#### Soldering

- Complete removal of flux is recommended to avoid surface contamination that can result in an instable and/or high leakage current.
- Use resin-type or non-activated flux.
- Bear in mind that insufficient preheating may cause ceramic cracks.
- Rapid cooling by dipping in solvent is not recommended, otherwise a component may crack.

## Multilayer varistors (MLVs)

### Automotive series

#### SMD

#### Conductive adhesive gluing

- Only multilayer varistors (MLVs) with an AgPd termination are approved for conductive adhesive gluing.

#### Operation

- Use CTVS only within the specified operating temperature range.
- Use CTVS only within specified voltage and current ranges.
- Environmental conditions must not harm a CTVS. Only use them in normal atmospheric conditions. Reducing the atmosphere (e.g. hydrogen or nitrogen atmosphere) is prohibited.
- Prevent a CTVS from contacting liquids and solvents. Make sure that no water enters a CTVS (e.g. through plug terminals).
- Avoid dewing and condensation.
- EPCOS CTVS components are mainly designed for encased applications. Under all circumstances avoid exposure to:
  - direct sunlight
  - rain or condensation
  - steam, saline spray
  - corrosive gases
  - atmosphere with reduced oxygen content
- EPCOS CTVS devices are not suitable for switching applications or voltage stabilization where static power dissipation is required.
- Multilayer varistors (MLVs) are designed for ESD protection and transient suppression. CeraDiodes are designed for ESD protection only, ESD/EMI filters are designed for ESD and EMI protection only.

This listing does not claim to be complete, but merely reflects the experience of EPCOS AG.

## Important notes

The following applies to all products named in this publication:

1. Some parts of this publication contain **statements about the suitability of our products for certain areas of application**. These statements are based on our knowledge of typical requirements that are often placed on our products in the areas of application concerned. We nevertheless expressly point out **that such statements cannot be regarded as binding statements about the suitability of our products for a particular customer application**. As a rule, EPCOS is either unfamiliar with individual customer applications or less familiar with them than the customers themselves. For these reasons, it is always ultimately incumbent on the customer to check and decide whether an EPCOS product with the properties described in the product specification is suitable for use in a particular customer application.
2. We also point out that **in individual cases, a malfunction of electronic components or failure before the end of their usual service life cannot be completely ruled out in the current state of the art, even if they are operated as specified**. In customer applications requiring a very high level of operational safety and especially in customer applications in which the malfunction or failure of an electronic component could endanger human life or health (e.g. in accident prevention or lifesaving systems), it must therefore be ensured by means of suitable design of the customer application or other action taken by the customer (e.g. installation of protective circuitry or redundancy) that no injury or damage is sustained by third parties in the event of malfunction or failure of an electronic component.
3. **The warnings, cautions and product-specific notes must be observed.**
4. In order to satisfy certain technical requirements, **some of the products described in this publication may contain substances subject to restrictions in certain jurisdictions (e.g. because they are classed as hazardous)**. Useful information on this will be found in our Material Data Sheets on the Internet ([www.epcos.com/material](http://www.epcos.com/material)). Should you have any more detailed questions, please contact our sales offices.
5. We constantly strive to improve our products. Consequently, **the products described in this publication may change from time to time**. The same is true of the corresponding product specifications. Please check therefore to what extent product descriptions and specifications contained in this publication are still applicable before or when you place an order. We also **reserve the right to discontinue production and delivery of products**. Consequently, we cannot guarantee that all products named in this publication will always be available. The aforementioned does not apply in the case of individual agreements deviating from the foregoing for customer-specific products.
6. Unless otherwise agreed in individual contracts, **all orders are subject to the current version of the "General Terms of Delivery for Products and Services in the Electrical Industry" published by the German Electrical and Electronics Industry Association (ZVEI)**.
7. The trade names EPCOS, BAOKE, Alu-X, CeraDiode, CSMP, CSSP, CTVS, DeltaCap, DigiSiMic, DSSP, FormFit, MiniBlue, MiniCell, MKK, MKD, MLSC, MotorCap, PCC, PhaseCap, PhaseCube, PhaseMod, PhiCap, SIFERRIT, SIFI, SIKOREL, SilverCap, SIMDAD, SiMic, SIMID, SineFormer, SIOV, SIP5D, SIP5K, ThermoFuse, WindCap are **trade-marks registered or pending** in Europe and in other countries. Further information will be found on the Internet at [www.epcos.com/trademarks](http://www.epcos.com/trademarks).