

Ceramic transient voltage suppressors

SMD disk varistors standard series

Series/Type:

Date: August 2011

© EPCOS AG 2015. Reproduction, publication and dissemination of this publication, enclosures hereto and the information contained therein without EPCOS' prior express consent is prohibited.

EPCOS AG is a TDK Group Company.

SMD disk varistors (CU varistors)

Standard series

SMD

EPCOS type designation system for SMD disk varistor standard series

CU	4032	K	275	G2
Construction: CU \triangleq Encapsulated chip				
Case sizes: 3225 \triangleq 32 x 25 4032 \triangleq 40 x 32				
Varistor voltage tolerance: K \triangleq $\pm 10\%$				
Maximum RMS operating voltage (V_{RMS}): 275 \triangleq 275 V				
Taping mode: G2 \triangleq Taped, 330-mm reel				

SMD disk varistors (CU varistors)

Standard series

SMD

Features

- Electrical equivalents to leaded types SIOV-S05/S07
- Operating voltage up to 300 V_{RMS}
- SMD plastic package
- RoHS-compatible
- Suitable for lead-free soldering
- UL approved
- CSA approved (types with voltages higher than 130 V_{RMS})
- PSpice models available



Applications

- Overvoltage protection and transient suppression in control electronics, detectors and sensors, touch screens, plug-in cards, remote controls

Design

- Cylindrical varistor element, encapsulated.
- Encapsulation: thermoplastic, flame-retardant to UL 94 V-0.
- Termination: tinned copper alloy, suitable for lead-free wave and reflow soldering, and compatible with tin/lead solder.

V/I characteristics and derating curves

V/I and derating curves are attached to the data sheet. The curves are sorted by V_{RMS} and then by case size, which is included in the type designation.

General technical data

Maximum RMS operating voltage		V _{RMS,max}	11 ... 300	V
Maximum DC operating voltage		V _{DC,max}	14 ... 385	V
Maximum surge current	(8/20 μs)	I _{surge,max}	100 ... 1200	A
Maximum energy absorption	(2 ms)	W _{max}	300 ... 23000	mJ
Maximum power dissipation		P _{diss,max}	10 ... 250	mW
Maximum clamping voltage	(8/20 μs)	V _{clamp,max}	36 ... 775	V
Operating temperature		T _{op}	-40/+85	°C
Storage temperature		LCT/UCT	-40/+125	°C

Temperature derating

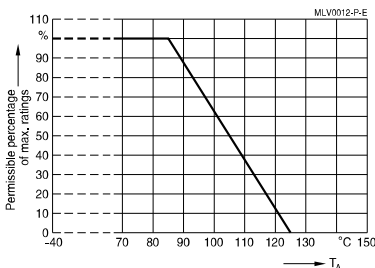

Climatic category: -40/+85 °C

SMD disk varistors (CU varistors)
Standard series
SMD
Electrical specifications and ordering codes
Maximum ratings ($T_{op,max} = 85\text{ }^{\circ}\text{C}$)

Type	Ordering code	$V_{RMS,max}$	$V_{DC,max}$	$I_{surge,max}$	W_{max}	$P_{diss,max}$
		V	V	(8/20 μs) A	(2 ms) mJ	mW
CU3225K11G2	B72650M0110K072	11	14	100	300	10
CU4032K11G2	B72660M0110K072	11	14	250	800	20
CU3225K14G2	B72650M0140K072	14	18	100	400	10
CU4032K14G2	B72660M0140K072	14	18	250	900	20
CU3225K17G2	B72650M0170K072	17	22	100	500	10
CU4032K17G2	B72660M0170K072	17	22	250	1100	20
CU3225K20G2	B72650M0200K072	20	26	100	600	10
CU4032K20G2	B72660M0200K072	20	26	250	1300	20
CU3225K25G2	B72650M0250K072	25	31	100	700	10
CU4032K25G2	B72660M0250K072	25	31	250	1600	20
CU3225K30G2	B72650M0300K072	30	38	100	900	10
CU4032K30G2	B72660M0300K072	30	38	250	2000	20
CU3225K35G2	B72650M0350K072	35	45	100	1100	10
CU4032K35G2	B72660M0350K072	35	45	250	2500	20
CU3225K40G2	B72650M0400K072	40	56	100	1300	10
CU4032K40G2	B72660M0400K072	40	56	250	3000	20
CU3225K50G2	B72650M0500K072	50	65	400	1800	100
CU4032K50G2	B72660M0500K072	50	65	1200	4200	250
CU3225K60G2	B72650M0600K072	60	85	400	2200	100
CU4032K60G2	B72660M0600K072	60	85	1200	4800	250
CU3225K75G2	B72650M0750K072	75	100	400	2500	100
CU4032K75G2	B72660M0750K072	75	100	1200	5900	250
CU3225K95G2	B72650M0950K072	95	125	400	3400	100
CU4032K95G2	B72660M0950K072	95	125	1200	7600	250
CU3225K115G2	B72650M0111K072	115	150	400	3600	100
CU4032K115G2	B72660M0111K072	115	150	1200	8400	250
CU3225K130G2	B72650M0131K072	130	170	400	4200	100
CU4032K130G2	B72660M0131K072	130	170	1200	9500	250
CU3225K140G2	B72650M0141K072	140	180	400	4500	100
CU4032K140G2	B72660M0141K072	140	180	1200	10000	250
CU3225K150G2	B72650M0151K072	150	200	400	4900	100
CU4032K150G2	B72660M0151K072	150	200	1200	11000	250
CU3225K175G2	B72650M0171K072	175	225	400	5600	100
CU4032K175G2	B72660M0171K072	175	225	1200	13000	250

SMD disk varistors (CU varistors)
Standard series
SMD
Characteristics (T_A = 25 °C)

Type	V _V (1 mA) V	ΔV _V %	V _{clamp,max} V	I _{clamp} (8/20 μs) A	C _{typ} (1 kHz, 1 V) pF
CU3225K11G2	18	±10	36	1	1750
CU4032K11G2	18	±10	36	2.5	2750
CU3225K14G2	22	±10	43	1	1450
CU4032K14G2	22	±10	43	2.5	2300
CU3225K17G2	27	±10	53	1	1200
CU4032K17G2	27	±10	53	2.5	1900
CU3225K20G2	33	±10	65	1	980
CU4032K20G2	33	±10	65	2.5	1600
CU3225K25G2	39	±10	77	1	850
CU4032K25G2	39	±10	77	2.5	1400
CU3225K30G2	47	±10	93	1	720
CU4032K30G2	47	±10	93	2.5	1200
CU3225K35G2	56	±10	110	1	620
CU4032K35G2	56	±10	110	2.5	1050
CU3225K40G2	68	±10	135	1	520
CU4032K40G2	68	±10	135	2.5	900
CU3225K50G2	82	±10	135	5	300
CU4032K50G2	82	±10	135	10	530
CU3225K60G2	100	±10	165	5	250
CU4032K60G2	100	±10	165	10	480
CU3225K75G2	120	±10	200	5	210
CU4032K75G2	120	±10	200	10	430
CU3225K95G2	150	±10	250	5	135
CU4032K95G2	150	±10	250	10	260
CU3225K115G2	180	±10	300	5	110
CU4032K115G2	180	±10	300	10	220
CU3225K130G2	205	±10	340	5	100
CU4032K130G2	205	±10	340	10	200
CU3225K140G2	220	±10	360	5	95
CU4032K140G2	220	±10	360	10	180
CU3225K150G2	240	±10	395	5	90
CU4032K150G2	240	±10	395	10	170
CU3225K175G2	270	±10	455	5	75
CU4032K175G2	270	±10	455	10	150

SMD disk varistors (CU varistors)
Standard series
SMD
Electrical specifications and ordering codes
Maximum ratings ($T_{op,max} = 85\text{ °C}$)

Type	Ordering code	$V_{RMS,max}$ V	$V_{DC,max}$ V	$I_{surge,max}$ (8/20 μ s) A	W_{max} (2 ms) mJ	$P_{diss,max}$ mW
CU3225K250G2	B72650M0251K072	250	320	400	8200	100
CU4032K250G2	B72660M0251K072	250	320	1200	19000	250
CU3225K275G2	B72650M0271K072	275	350	400	8600	100
CU4032K275G2	B72660M0271K072	275	350	1200	21000	250
CU3225K300G2	B72650M0301K072	300	385	400	9600	100
CU4032K300G2	B72660M0301K072	300	385	1200	23000	250

Characteristics ($T_A = 25\text{ °C}$)

Type	V_V (1 mA) V	ΔV_V %	$V_{clamp,max}$ V	I_{clamp} (8/20 μ s) A	C_{typ} (1 kHz, 1 V) pF
CU3225K250G2	390	± 10	650	5	55
CU4032K250G2	390	± 10	650	10	105
CU3225K275G2	430	± 10	710	5	50
CU4032K275G2	430	± 10	710	10	95
CU3225K300G2	470	± 10	775	5	45
CU4032K300G2	470	± 10	775	10	90

SMD disk varistors (CU varistors)

Standard series

SMD

Dimensional drawing

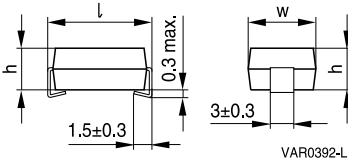

Dimensions in mm

Chip size EIA in mm	$V_{RMS,max}$	l	w	h
3225	11 ... 175	8.0 ± 0.3	6.3 ± 0.3	3.2 ± 0.3
3225	230 ... 300	8.0 ± 0.3	6.3 ± 0.3	4.5 ± 0.3
4032	11 ... 175	10.2 ± 0.3	8.0 ± 0.3	3.2 ± 0.3
4032	230 ... 300	10.2 ± 0.3	8.0 ± 0.3	4.5 ± 0.3

Recommended solder pad layout



Dimensions in mm

Chip size EIA in mm	A	B	C
3225	3.50	2.80	4.50
4032	3.50	2.80	6.50

SMD disk varistors (CU varistors)
Standard series
SMD
Delivery mode

EIA case size	Taping	Reel size mm	Packing unit pcs.	Type	Ordering code
3225	Blister	330	1000	CU3225K115G2	B72650M0111K072
3225	Blister	330	1000	CU3225K11G2	B72650M0110K072
3225	Blister	330	1000	CU3225K130G2	B72650M0131K072
3225	Blister	330	1000	CU3225K140G2	B72650M0141K072
3225	Blister	330	1000	CU3225K14G2	B72650M0140K072
3225	Blister	330	1000	CU3225K150G2	B72650M0151K072
3225	Blister	330	1000	CU3225K175G2	B72650M0171K072
3225	Blister	330	1000	CU3225K20G2	B72650M0200K072
3225	Blister	330	1000	CU3225K230G2	B72650M0231K072
3225	Blister	330	1000	CU3225K250G2	B72650M0251K072
3225	Blister	330	1000	CU3225K25G2	B72650M0250K072
3225	Blister	330	1000	CU3225K275G2	B72650M0271K072
3225	Blister	330	1000	CU3225K300G2	B72650M0301K072
3225	Blister	330	1000	CU3225K30G2	B72650M0300K072
3225	Blister	330	1000	CU3225K35G2	B72650M0350K072
3225	Blister	330	1000	CU3225K40G2	B72650M0400K072
3225	Blister	330	1000	CU3225K50G2	B72650M0500K072
3225	Blister	330	1000	CU3225K60G2	B72650M0600K072
3225	Blister	330	1000	CU3225K75G2	B72650M0750K072
3225	Blister	330	1000	CU3225K95G2	B72650M0950K072
3225	Blister	330	1000	CU4032K11G2	B72660M0110K072
4032	Blister	330	1000	CU3225K17G2	B72650M0170K072
4032	Blister	330	1000	CU4032K115G2	B72660M0111K072
4032	Blister	330	1000	CU4032K130G2	B72660M0131K072
4032	Blister	330	1000	CU4032K140G2	B72660M0141K072
4032	Blister	330	1000	CU4032K14G2	B72660M0140K072
4032	Blister	330	1000	CU4032K150G2	B72660M0151K072
4032	Blister	330	1000	CU4032K175G2	B72660M0171K072
4032	Blister	330	1000	CU4032K17G2	B72660M0170K072
4032	Blister	330	1000	CU4032K20G2	B72660M0200K072
4032	Blister	330	1000	CU4032K230G2	B72660M0231K072
4032	Blister	330	1000	CU4032K250G2	B72660M0251K072
4032	Blister	330	1000	CU4032K25G2	B72660M0250K072
4032	Blister	330	1000	CU4032K275G2	B72660M0271K072
4032	Blister	330	1000	CU4032K300G2	B72660M0301K072
4032	Blister	330	1000	CU4032K30G2	B72660M0300K072
4032	Blister	330	1000	CU4032K35G2	B72660M0350K072
4032	Blister	330	1000	CU4032K40G2	B72660M0400K072
4032	Blister	330	1000	CU4032K50G2	B72660M0500K072
4032	Blister	330	1000	CU4032K60G2	B72660M0600K072
4032	Blister	330	1000	CU4032K75G2	B72660M0750K072
4032	Blister	330	1000	CU4032K95G2	B72660M0950K072

SMD disk varistors (CU varistors)

Standard series

SMD

V/I characteristics



CU3225 ...

SMD disk varistors (CU varistors)

Standard series

SMD

V/I characteristics



CU4032 ...

SMD disk varistors (CU varistors)

Standard series

SMD

Derating curves

Maximum surge current $I_{\text{surge,max}} = f(t_r, \text{pulse train})$

For explanation of the derating curves refer to "General technical information", chapter 2.7.2

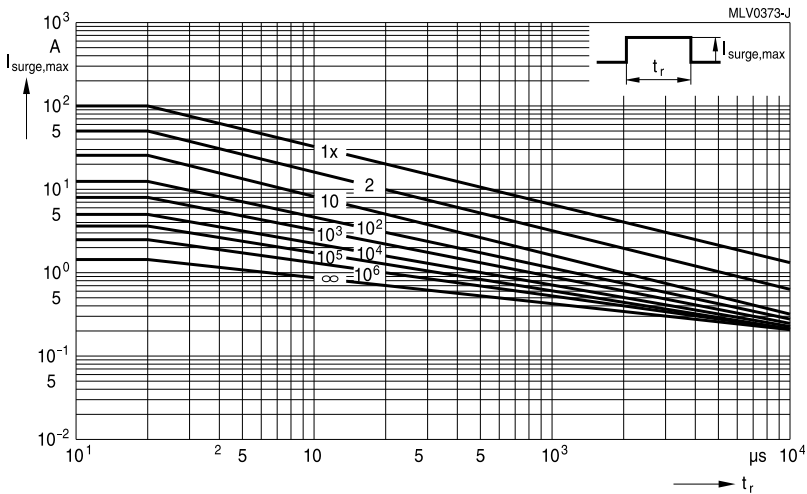

CU3225K11G2 ... K40G2

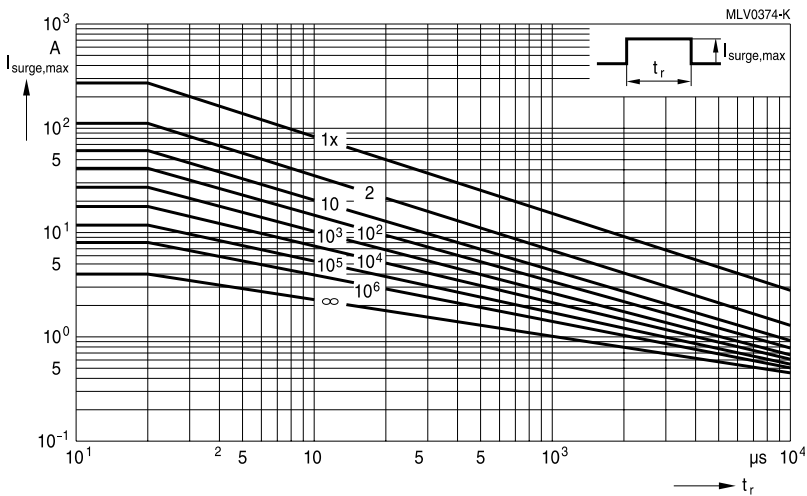

CU4032K11G2 ... K40G2

SMD disk varistors (CU varistors)

Standard series

SMD

Derating curves

Maximum surge current $I_{\text{surge,max}} = f(t_r, \text{pulse train})$

For explanation of the derating curves refer to "General technical information", chapter 2.7.2

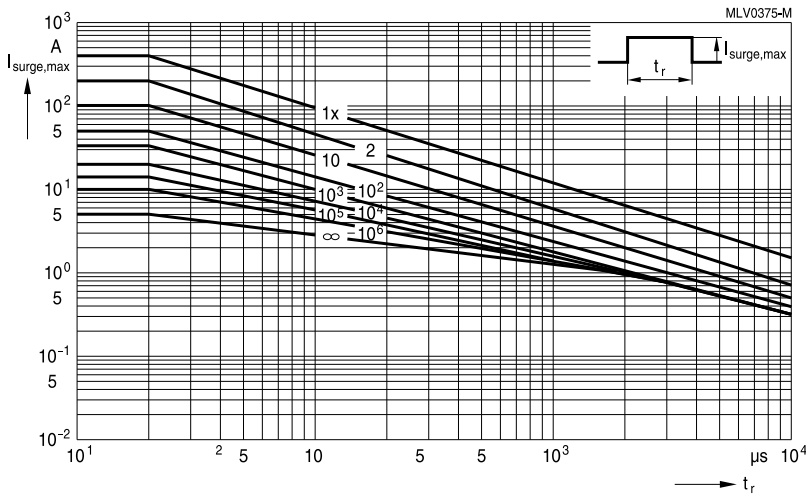

CU3225K50G2 ... K300G2

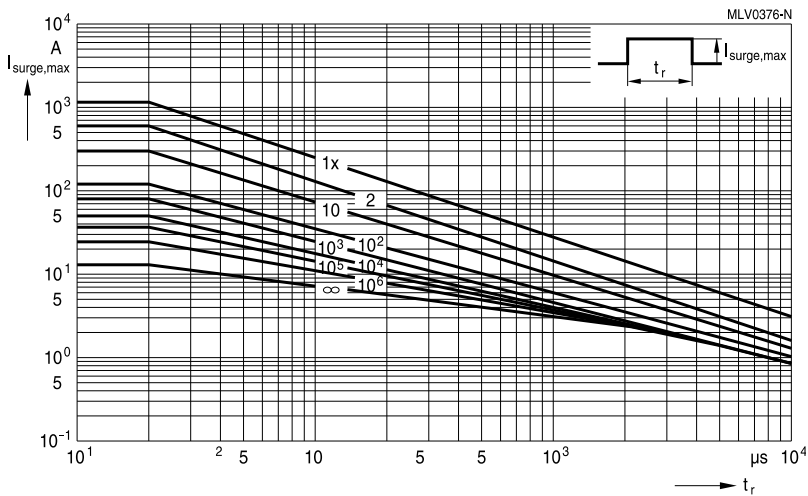

CU4032K50G2 ... K300G2

SMD disk varistors (CU varistors)

Standard series

SMD

Taping and packing

1 Taping and packing for SMD components

1.1 Blister tape (the taping to IEC 60286-3)

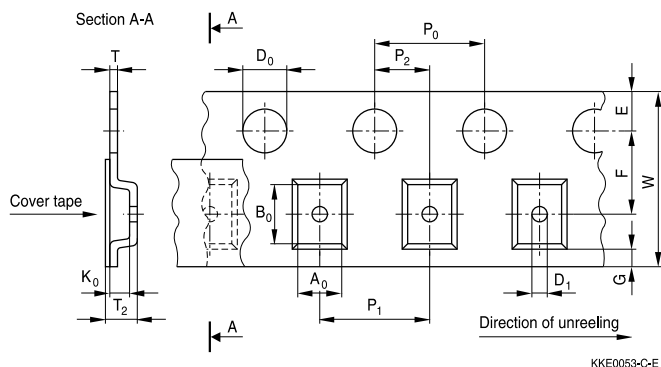

Dimensions in mm

	8-mm tape					12-mm tape		16-mm tape		Tolerance
	Case size (inch/mm)					Case size (inch/mm)		Case size (inch/mm)		
			0508/ 1220	0612/ 1632	1012/ 2532					
	0603/ 1608	0506/ 1216	0805/ 2012	1206/ 3216	1210/ 3225	1812/ 4532	2220/ 5750	3225	4032	
A ₀	0.9 ±0.10	1.50	1.60	1.90	2.80	3.50	5.10	7.00	8.60	±0.20
B ₀	1.75 ±0.10	1.80	2.40	3.50	3.50	4.80	6.00	8.70	10.60	±0.20
K ₀	1.0	0.80	1.80			2.60		5.00		max.
T	0.30					0.30		0.30		max.
T ₂	1.3	1.20	2.50			3.50		5.50		max.
D ₀	1.50					1.50		1.50		+0.10/-0
D ₁	1.00					1.50		1.50		min.
P ₀	4.00					4.00		4.00		±0.10 ¹⁾
P ₂	2.00					2.00		2.00		±0.05
P ₁	4.00					8.00		12.00		±0.10
W	8.00					12.00		16.00		±0.30
E	1.75					1.75		1.75		±0.10
F	3.50					5.50		7.50		±0.05
G	0.75					0.75		0.75		min.

1) ≤±0.2 mm over 10 sprocket holes.

SMD disk varistors (CU varistors)

Standard series

SMD

Part orientation in tape pocket for blister tape

For discrete chip, case sizes 0603, 0805, 1206, 1210, 1812 and 2220

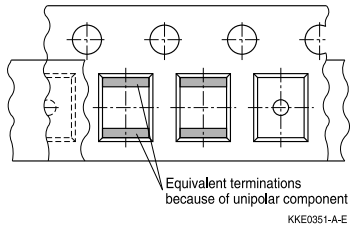

For array, case sizes 0612

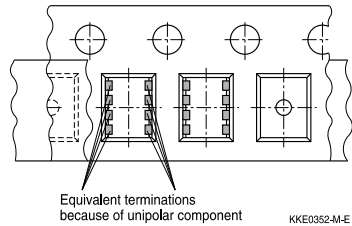

For arrays 0506 and 1012

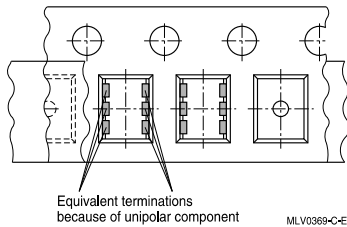

For filter array, case size 0508

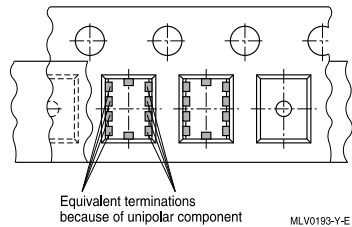

Additional taping information

Reel material	Polystyrol (PS)
Tape material	Polystyrol (PS) or Polycarbonat (PC) or PVC
Tape break force	min. 10 N
Top cover tape strength	min. 10 N
Top cover tape peel force	0.2 to 0.6 N for 8-mm tape and 0.2 to 0.8 N for 12-mm tape at a peel speed of 300 mm/min
Tape peel angle	Angle between top cover tape and the direction of feed during peel off: 165° to 180°
Cavity play	Each part rests in the cavity so that the angle between the part and cavity center line is no more than 20°

SMD disk varistors (CU varistors)

Standard series

SMD

1.2 Cardboard tape (taping to IEC 60286-3)

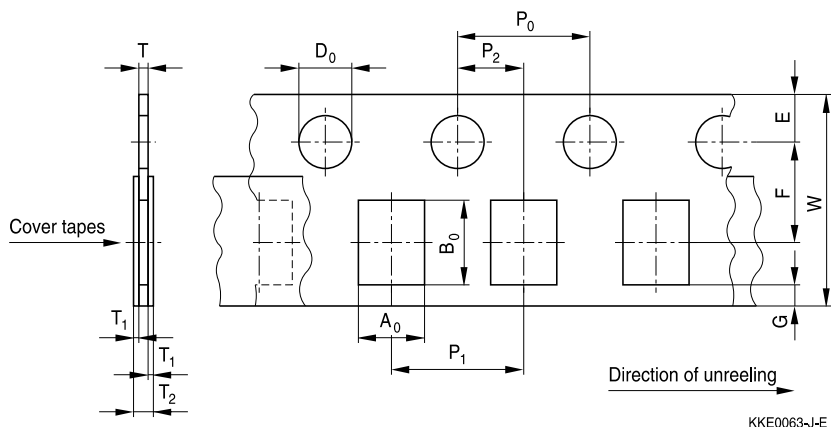

Dimensions in mm

	8-mm tape						Tolerance
	Case size (inch/mm)					Case size (inch/mm)	
	0201/0603	0402/1005	0405/1012	0603/1608	1003/2508	0508/1220	
A_0	0.38 ± 0.05	0.60	1.05	0.95	1.00	1.60	± 0.20
B_0	0.68 ± 0.05	1.15	1.60	1.80	2.85	2.40	± 0.20
T	0.35 ± 0.02	0.60	0.75	0.95	1.00	0.95	max.
T_2	0.4 min.	0.70	0.90	1.10	1.10	1.12	max.
D_0	1.50 ± 0.1	1.50				1.50	$+0.10/-0$
P_0	4.00						$\pm 0.10^{2)}$
P_2	2.00						± 0.05
P_1	2.00 ± 0.05	2.00	4.00	4.00	4.00	4.00	± 0.10
W	8.00						± 0.30
E	1.75						± 0.10
F	3.50						± 0.05
G	1.35	0.75					min.

2) ≤ 0.2 mm over 10 sprocket holes.

SMD disk varistors (CU varistors)

Standard series

SMD

Part orientation in tape pocket for cardboard tape

For discrete chip case sizes 0201, 0402, 0603 and 1003

For array case size 0405

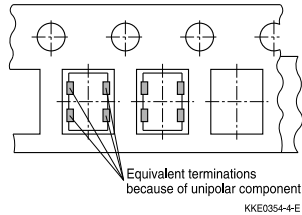
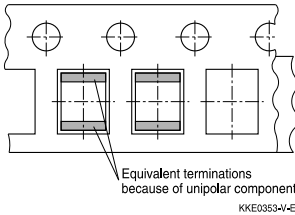

For array case size 0508

For filter array, case size 0405

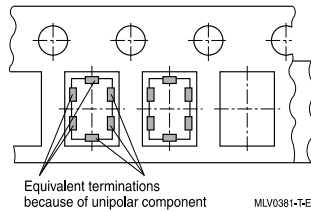
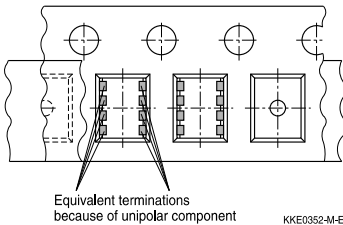

Additional taping information

Reel material	Polystyrol (PS)
Tape material	Cardboard
Tape break force	min. 10 N
Top cover tape strength	min. 10 N
Top cover tape peel force	0.1 to 0.65 N at a peel speed of 300 mm/min
Tape peel angle	Angle between top cover tape and the direction of feed during peel off: 165° to 180°
Cavity play	Each part rests in the cavity so that the angle between the part and cavity center line is no more than 20°

SMD disk varistors (CU varistors)

Standard series

SMD

1.3 Reel packing



Dimensions in mm

	8-mm tape		12-mm tape		16-mm tape
	180-mm reel	330-mm reel	180-mm reel	330-mm reel	330-mm reel
A	180 -3/+0	330 -2.0	180 -3/+0	330 -2.0	330 -2.0
W ₁	8.4 +1.5/-0	8.4 +1.5/-0	12.4 +1.5/-0	12.4 +1.5/-0	16.4 +1.5/-0
W ₂	14.4 max.	14.4 max.	18.4 max.	18.4 max.	22.4 max.

Leader, trailer



Tape end (Trailer)



Leader part

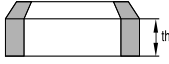
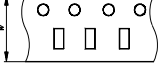

SMD disk varistors (CU varistors)
Standard series
SMD
1.4 Packing units for discrete chip and array chip

Case size inch/mm	 Chip thickness th			 Ø 180-mm reel	 Ø 330-mm reel
		Cardboard tape W	Blister tape W	pcs.	pcs.
0201/0603	0.33 mm	8 mm	–	15000	–
0402/1005	0.6 mm	8 mm	–	10000	–
0405/1012	0.7 mm	8 mm	–	5000	–
0506/1216	0.5 mm	–	8 mm	4000	–
0508/1220	0.9 mm	8 mm	8 mm	4000	–
0603/1608	0.9 mm	8 mm	8 mm	4000	16000
0612/1632	0.9 mm	–	8 mm	3000	–
0805/2012	0.7 mm	–	8 mm	3000	–
	0.9 mm	–	8 mm	3000	12000
	1.3 mm	–	8 mm	3000	–
1003/2508	0.9 mm	8 mm	–	4000	–
1012/2532	1.0 mm	–	8 mm	2000	–
1206/3216	0.9 mm	–	8 mm	3000	–
	1.3 mm	–	8 mm	3000	–
	1.4 mm	–	8 mm	2000	–
	1.6 mm	–	8 mm	2000	–
1210/3225	0.9 mm	–	8 mm	3000	–
	1.3 mm	–	8 mm	3000	–
	1.4 mm	–	8 mm	2000	–
	1.6 mm	–	8 mm	2000	–
1812/4532	1.3 mm	–	12 mm	1500	–
	1.4 mm	–	12 mm	1000	–
	1.6 mm	–	12 mm	–	4000
	2.3 mm	–	12 mm	–	3000
2220/5750	1.3 mm	–	12 mm	1500	–
	1.4 mm	–	12 mm	1000	–
	2.0 mm	–	12 mm	–	3000
	2.3 mm	–	12 mm	–	3000
3225	3.2 mm	–	16 mm	–	1000
	4.5 mm	–	16 mm	–	1000
4032	3.2 mm	–	16 mm	–	1000
	4.5 mm	–	16 mm	–	1000

SMD disk varistors (CU varistors)**Standard series****SMD****2 Delivery mode for leaded SHCV varistors**

Standard delivery mode for SHCV types is bulk. Alternative taping modes (AMMO pack or taped on reel) are available upon request.

Packing units for:

Type	Pieces
SR6	2000
SR1 / SR2	1000

For types not listed in this data book please contact EPCOS.

SMD disk varistors (CU varistors)

Standard series

SMD

Soldering directions

1 Terminations

1.1 Nickel barrier termination

The nickel barrier layer of the silver/nickel/tin termination prevents leaching of the silver base metallization layer. This allows great flexibility in the selection of soldering parameters. The tin prevents the nickel layer from oxidizing and thus ensures better wetting by the solder. The nickel barrier termination is suitable for all commonly-used soldering methods.

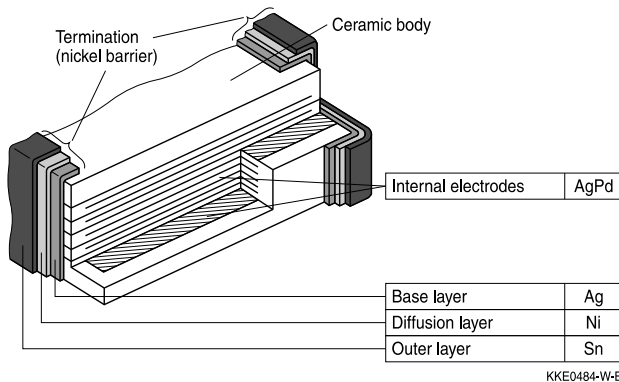

Multilayer CTVS: Structure of nickel barrier termination

1.2 Silver-palladium termination

Silver-palladium terminations are used for the large case sizes 1812 and 2220 and for chips intended for conductive adhesion. This metallization improves the resistance of large chips to thermal shock.

In case of conductive adhesion, the silver-palladium metallization reduces susceptibility to corrosion. Silver-palladium termination can be used for smaller case sizes (only chip) for hybrid applications as well. The silver-palladium termination is not approved for lead-free soldering.



Multilayer varistor: Structure of silver-palladium termination

SMD disk varistors (CU varistors)

Standard series

SMD

1.3 Silver-platinum termination

Silver-platinum terminations are mainly used for the large case sizes 1812 and 2220. The silver-platinum termination is approved for reflow soldering, SnPb soldering and lead-free soldering with a silver containing solder paste. In case of SnPb soldering, a solder paste Sn62Pb36Ag2 is recommended. For lead-free reflow soldering, a solder paste SAC, e.g. Sn95.5Ag3.8Cu0.7, is recommended.

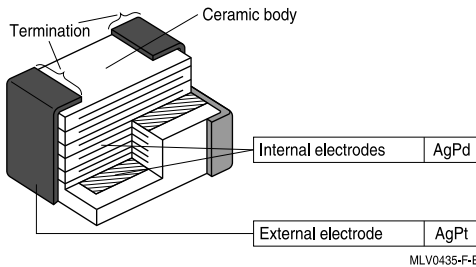

Multilayer varistor: Structure of silver-platinum termination

2 Recommended soldering temperature profiles

2.1 Reflow soldering temperature profile

Recommended temperature characteristic for reflow soldering following JEDEC J-STD-020D



SMD disk varistors (CU varistors)

Standard series

SMD

Profile feature		Sn-Pb eutectic assembly	Pb-free assembly
Preheat and soak			
- Temperature min	T_{smin}	100 °C	150 °C
- Temperature max	T_{smax}	150 °C	200 °C
- Time	t_{smin} to t_{smax}	60 ... 120 s	60 ... 180 s
Average ramp-up rate	T_{smax} to T_p	3 °C/ s max.	3 °C/ s max.
Liquidous temperature	T_L	183 °C	217 °C
Time at liquidous	t_L	60 ... 150 s	60 ... 150 s
Peak package body temperature	T_p ¹⁾	220 °C ... 235 °C ²⁾	245 °C ... 260 °C ²⁾
Time (t_p) ³⁾ within 5 °C of specified classification temperature (T_c)		20 s ³⁾	30 s ³⁾
Average ramp-down rate	T_p to T_{smax}	6 °C/ s max.	6 °C/ s max.
Time 25 °C to peak temperature		maximum 6 min	maximum 8 min

1) Tolerance for peak profile temperature (T_p) is defined as a supplier minimum and a user maximum.

2) Depending on package thickness. For details please refer to JEDEC J-STD-020D.

3) Tolerance for time at peak profile temperature (t_p) is defined as a supplier minimum and a user maximum.

Note: All temperatures refer to topside of the package, measured on the package body surface.
Number of reflow cycles: 3

2.2 Wave soldering temperature profile

Temperature characteristics at component terminal with dual-wave soldering

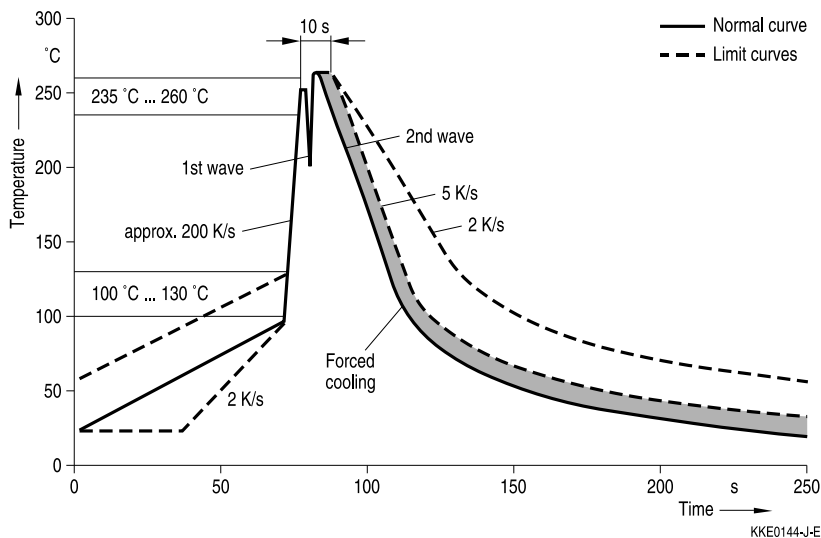

KKE0144-J-E

SMD disk varistors (CU varistors)

Standard series

SMD

2.3 Lead-free soldering processes

EPCOS multilayer CTVS with AgNiSn termination are designed for the requirements of lead-free soldering processes only.

Soldering temperature profiles to JEDEC J-STD-020D, IEC 60068-2-58 and ZVEI recommendations.

3 Recommended soldering methods - type-specific releases by EPCOS

3.1 Overview

Type	Case size	Reflow soldering		Wave soldering	
		SnPb	Lead-free	SnPb	Lead-free
CT... / CD...	0201/ 0402	Approved	Approved	No	No
CT... / CD...	0603 ... 2220	Approved	Approved	Approved	Approved
CN...	0603 ... 2220	Approved	No	Approved	No
CN...K2	1812, 2220	Approved	Approved	No	No
Arrays	0405 ... 1012	Approved	Approved	No	No
ESD/EMI filters	0405, 0508	Approved	Approved	No	No
CU	3225, 4032	Approved	Approved	Approved	Approved
SHCV	-	No	No	Approved	Approved

3.2 Nickel barrier and AgPt terminated multilayer CTVS

All EPCOS MLVs with nickel barrier and AgPt termination are suitable and fully qualified for lead-free soldering. The nickel barrier layer is 100% matte tin-plated.

3.3 Silver-palladium terminated MLVs

AgPd-terminated MLVs are mainly designed for conductive adhesion technology on hybrid material. Additionally MLVs with AgPd termination are suitable for reflow and wave soldering with SnPb solder.

Note:

Lead-free soldering is not approved for MLVs with AgPd termination.

3.4 Silver-platinum terminated MLVs

The silver-platinum termination is approved for reflow soldering, SnPb soldering and lead-free with a silver containing solder paste. In case of SnPb soldering, a solder paste Sn62Pb36Ag2 is recommended. For lead-free reflow soldering, a solder paste SAC, e.g. Sn95.5Ag3.8Cu0.7, is recommended.

SMD disk varistors (CU varistors)

Standard series

SMD

3.5 Tinned copper alloy

All EPCOS CU types with tinned termination are approved for lead-free and SnPb soldering.

3.6 Tinned iron wire

All EPCOS SHCV types with tinned termination are approved for lead-free and SnPb soldering.

4 Solder joint profiles / solder quantity

4.1 Nickel barrier termination

If the meniscus height is too low, that means the solder quantity is too low, the solder joint may break, i.e. the component becomes detached from the joint. This problem is sometimes interpreted as leaching of the external terminations.

If the solder meniscus is too high, i.e. the solder quantity is too large, the vise effect may occur. As the solder cools down, the solder contracts in the direction of the component. If there is too much solder on the component, it has no leeway to evade the stress and may break, as in a vise.

The figures below show good and poor solder joints for dual-wave and infrared soldering.

4.1.1 Solder joint profiles for nickel barrier termination - dual-wave soldering

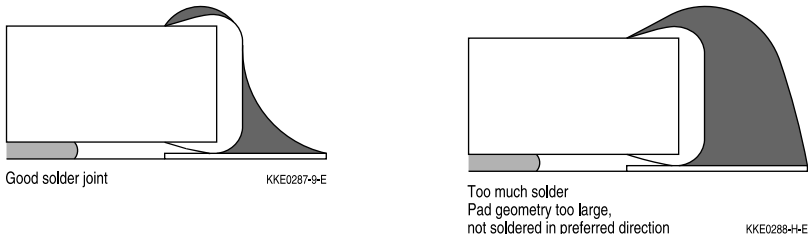

Good and poor solder joints caused by amount of solder in dual-wave soldering.

4.1.2 Solder joint profiles for nickel barrier termination / silver-palladium / silver-platinum termination - reflow soldering

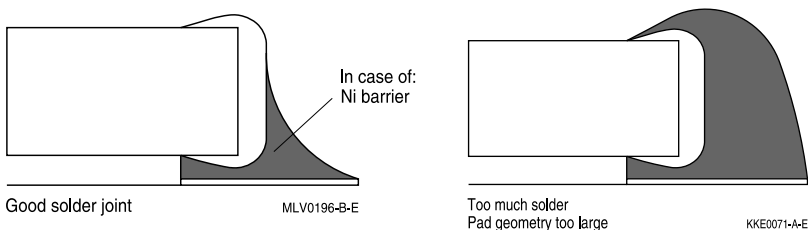

SMD disk varistors (CU varistors)

Standard series

SMD

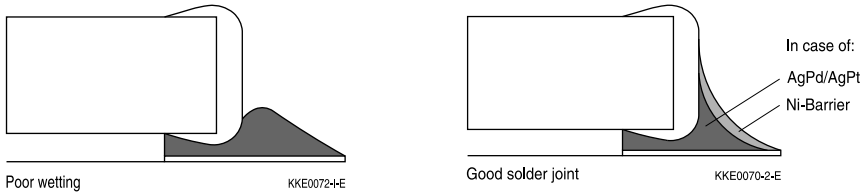

Good and poor solder joints caused by amount of solder in reflow soldering.

5 Conductive adhesion

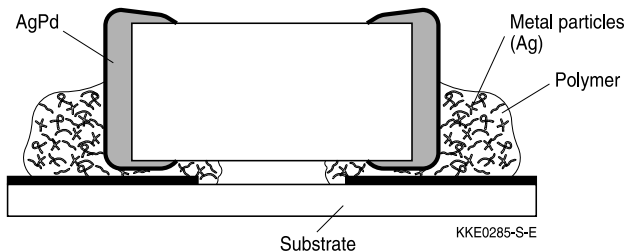

Attaching surface-mounted devices (SMDs) with electrically conductive adhesives is a commercially attractive method of component connection to supplement or even replace conventional soldering methods.

Electrically conductive adhesives consist of a non-conductive plastic (epoxy resin, polyimide or silicon) in which electrically conductive metal particles (gold, silver, palladium, nickel, etc) are embedded. Electrical conduction is effected by contact between the metal particles.

Adhesion is particularly suitable for meeting the demands of hybrid technology. The adhesives can be deposited ready for production requirements by screen printing, stamping or by dispensers. As shown in the following table, conductive adhesion involves two work operations fewer than soldering.

Reflow soldering	Wave soldering	Conductive adhesion
Screen-print solder paste	Apply glue dot	Screen-print conductive adhesive
Mount SMD	Mount SMD	Mount SMD
Predry solder paste	Cure glue	Cure adhesive
Reflow soldering	Wave soldering	Inspect
Wash	Wash	
Inspect	Inspect	

SMD disk varistors (CU varistors)

Standard series

SMD

A further advantage of adhesion is that the components are subjected to virtually no temperature shock at all. The curing temperatures of the adhesives are between 120 °C and 180 °C, typical curing times are between 30 minutes and one hour.

The bending strength of glued chips is, in comparison with that of soldered chips, higher by a factor of at least 2, as is to be expected due to the elasticity of the glued joints.

The lower conductivity of conductive adhesive may lead to higher contact resistance and thus result in electrical data different to those of soldered components. Users must pay special attention to this in RF applications.

6 Solderability tests

Test	Standard	Test conditions Sn-Pb soldering	Test conditions Pb-free soldering	Criteria/ test results
Wettability	IEC 60068-2-58	Immersion in 60/40 SnPb solder using non-activated flux at 215 ± 3 °C for 3 ± 0.3 s	Immersion in Sn96.5Ag3.0Cu0.5 solder using non- or low activated flux at 245 ± 5 °C for 3 ± 0.3 s	Covering of 95% of end termination, checked by visual inspection
Leaching resistance	IEC 60068-2-58	Immersion in 60/40 SnPb solder using mildly activated flux without preheating at 260 ± 5 °C for 10 ± 1 s	Immersion in Sn96.5Ag3.0Cu0.5 solder using non- or low activated flux without preheating at 255 ± 5 °C for 10 ± 1 s	No leaching of contacts
Thermal shock (solder shock)		Dip soldering at 300 °C/5 s	Dip soldering at 300 °C/5 s	No deterioration of electrical parameters. Capacitance change: $\leq \pm 15\%$
Tests of resistance to soldering heat for SMDs	IEC 60068-2-58	Immersion in 60/40 SnPb for 10 s at 260 °C	Immersion in Sn96.5Ag3.0Cu0.5 for 10 s at 260 °C	Change of varistor voltage: $\leq \pm 5\%$
Tests of resistance to soldering heat for radial leaded components (SHCV)	IEC 60068-2-20	Immersion of leads in 60/40 SnPb for 10 s at 260 °C	Immersion of leads in Sn96.5Ag3.0Cu0.5 for 10 s at 260 °C	Change of varistor voltage: $\leq \pm 5\%$ Change of capacitance X7R: $\leq -5/+10\%$

SMD disk varistors (CU varistors)

Standard series

SMD

Note:

Leaching of the termination

Effective area at the termination might be lost if the soldering temperature and/or immersion time are not kept within the recommended conditions. Leaching of the outer electrode should not exceed 25% of the chip end area (full length of the edge A-B-C-D) and 25% of the length A-B, shown below as mounted on substrate.



As a single chip



As mounted on substrate

7 Notes for proper soldering

7.1 Preheating and cooling

- According to JEDEC J-STD-020D. Please refer to chapter 2.

7.2 Repair / rework

Manual soldering with a soldering iron must be avoided, hot-air methods are recommended for rework purposes.

7.3 Cleaning

All environmentally compatible agents are suitable for cleaning. Select the appropriate cleaning solution according to the type of flux used. The temperature difference between the components and cleaning liquid must not be greater than 100 °C. Ultrasonic cleaning should be carried out with the utmost caution. Too high ultrasonic power can impair the adhesive strength of the metalized surfaces.

7.4 Solder paste printing (reflow soldering)

An excessive application of solder paste results in too high a solder fillet, thus making the chip more susceptible to mechanical and thermal stress. Too little solder paste reduces the adhesive strength on the outer electrodes and thus weakens the bonding to the PCB. The solder should be applied smoothly to the end surface.

SMD disk varistors (CU varistors)

Standard series

SMD

7.5 Adhesive application

Thin or insufficient adhesive causes chips to loosen or become disconnected during curing. Low viscosity of the adhesive causes chips to slip after mounting. It is advised to consult the manufacturer of the adhesive on proper usage and amounts of adhesive to use.

7.6 Selection of flux

Used flux should have less than or equal to 0.1 wt % of halogenated content, since flux residue after soldering could lead to corrosion of the termination and/or increased leakage current on the surface of the component. Strong acidic flux must not be used. The amount of flux applied should be carefully controlled, since an excess may generate flux gas, which in turn is detrimental to solderability.

7.7 Storage of CTVs

Solderability is guaranteed for one year from date of delivery for multilayer varistors, CeraDiodes and ESD/EMI filters (half a year for chips with AgPd and AgPt terminations) and two years for SHCV and CU components, provided that components are stored in their original packages.

Storage temperature: $-25\text{ }^{\circ}\text{C}$ to $+45\text{ }^{\circ}\text{C}$

Relative humidity: $\leq 75\%$ annual average, $\leq 95\%$ on 30 days a year

The solderability of the external electrodes may deteriorate if SMDs and leaded components are stored where they are exposed to high humidity, dust or harmful gas (hydrogen chloride, sulfurous acid gas or hydrogen sulfide).

Do not store SMDs and leaded components where they are exposed to heat or direct sunlight. Otherwise the packing material may be deformed or SMDs/ leaded components may stick together, causing problems during mounting.

After opening the factory seals, such as polyvinyl-sealed packages, it is recommended to use the SMDs or leaded components as soon as possible.

7.8 Placement of components on circuit board

Especially in the case of dual-wave soldering, it is of advantage to place the components on the board before soldering in that way that their two terminals do not enter the solder bath at different times.

Ideally, both terminals should be wetted simultaneously.

7.9 Soldering cautions

- An excessively long soldering time or high soldering temperature results in leaching of the outer electrodes, causing poor adhesion and a change of electrical properties of the varistor due to the loss of contact between electrodes and termination.
- Wave soldering must not be applied for MLVs designated for reflow soldering only.
- Keep the recommended down-cooling rate.

SMD disk varistors (CU varistors)

Standard series

SMD

7.10 Standards

CECC 00802

IEC 60068-2-58

IEC 60068-2-20

JEDEC J-STD-020D

SMD disk varistors (CU varistors)
Standard series
SMD
Symbols and terms

Symbol	Term
$C_{line,typ}$	Typical capacitance per line
C_{max}	Maximum capacitance
C_{min}	Minimum capacitance
C_{nom}	Nominal capacitance
ΔC_{nom}	Tolerance of nominal capacitance
C_{typ}	Typical capacitance
$f_{cut-off,min}$	Minimum cut-off frequency
I	Current
I_{clamp}	Clamping current
I_{leak}	Leakage current
$I_{leak,typ}$	Typical leakage current
I_{PP}	Peak pulse current
$I_{surge,max}$	Maximum surge current (also termed peak current)
LCT	Lower category temperature
L_{typ}	Typical inductance
$P_{diss,max}$	Maximum power dissipation
P_{PP}	Peak pulse power
R_{ins}	Insulation resistance
R_{min}	Minimum resistance
R_S	Resistance per line
T_A	Ambient temperature
T_{op}	Operating temperature
T_{stg}	Storage temperature
t_r	Duration of equivalent rectangular wave
t_{resp}	Response time
UCT	Upper category temperature
V	Voltage
$V_{BR,min}$	Minimum breakdown voltage
$V_{clamp,max}$	Maximum clamping voltage
$V_{DC,max}$	Maximum DC operating voltage (also termed working voltage)
$V_{ESD,air}$	Air discharge ESD capability
$V_{ESD,contact}$	Contact discharge ESD capability
V_{jump}	Maximum jump start voltage

SMD disk varistors (CU varistors)
Standard series
SMD

$V_{\text{RMS,max}}$	Maximum AC operating voltage, root-mean-square value
V_V	Varistor voltage (also termed breakdown voltage)
$V_{V,\text{min}}$	Minimum varistor voltage
$V_{V,\text{max}}$	Maximum varistor voltage
ΔV_V	Tolerance of varistor voltage
W_{LD}	Maximum load dump
W_{max}	Maximum energy absorption (also termed transient energy)
α_{typ}	Typical insertion loss
e	Lead spacing
$\ll * \gg$	Maximum possible application conditions

All dimensions are given in mm.

The commas used in numerical values denote decimal points.

SMD disk varistors (CU varistors)

Standard series

SMD

Cautions and warnings

General

Some parts of this publication contain statements about the suitability of our ceramic transient voltage suppressor (CTVS) components (multilayer varistors (MLVs), CeraDiodes, ESD/EMI filters, SMD disk varistors (CU types), leaded transient voltage/ RFI suppressors (SHCV types)) for certain areas of application, including recommendations about incorporation/design-in of these products into customer applications. The statements are based on our knowledge of typical requirements often made of our CTVS devices in the particular areas. We nevertheless expressly point out that such statements cannot be regarded as binding statements about the suitability of our CTVS components for a particular customer application. As a rule, EPCOS is either unfamiliar with individual customer applications or less familiar with them than the customers themselves. For these reasons, it is always incumbent on the customer to check and decide whether the CTVS devices with the properties described in the product specification are suitable for use in a particular customer application.

- Do not use EPCOS CTVS components for purposes not identified in our specifications, application notes and data books.
- Ensure the suitability of a CTVS in particular by testing it for reliability during design-in. Always evaluate a CTVS component under worst-case conditions.
- Pay special attention to the reliability of CTVS devices intended for use in safety-critical applications (e.g. medical equipment, automotive, spacecraft, nuclear power plant).

Design notes

- Always connect a CTVS in parallel with the electronic circuit to be protected.
- Consider maximum rated power dissipation if a CTVS has insufficient time to cool down between a number of pulses occurring within a specified isolated time period. Ensure that electrical characteristics do not degrade.
- Consider derating at higher operating temperatures. Choose the highest voltage class compatible with derating at higher temperatures.
- Surge currents beyond specified values will puncture a CTVS. In extreme cases a CTVS will burst.
- If steep surge current edges are to be expected, make sure your design is as low-inductance as possible.
- In some cases the malfunctioning of passive electronic components or failure before the end of their service life cannot be completely ruled out in the current state of the art, even if they are operated as specified. In applications requiring a very high level of operational safety and especially when the malfunction or failure of a passive electronic component could endanger human life or health (e.g. in accident prevention, life-saving systems, or automotive battery line applications such as clamp 30), ensure by suitable design of the application or other measures (e.g. installation of protective circuitry or redundancy) that no injury or damage is sustained by third parties in the event of such a malfunction or failure. Only use CTVS components from the automotive series in safety-relevant applications.

SMD disk varistors (CU varistors)

Standard series

SMD

- Specified values only apply to CTVS components that have not been subject to prior electrical, mechanical or thermal damage. The use of CTVS devices in line-to-ground applications is therefore not advisable, and it is only allowed together with safety countermeasures like thermal fuses.

Storage

- Only store CTVS in their original packaging. Do not open the package before storage.
- Storage conditions in original packaging: temperature -25 to $+45^{\circ}\text{C}$, relative humidity $\leq 75\%$ annual average, maximum 95%, dew precipitation is inadmissible.
- Do not store CTVS devices where they are exposed to heat or direct sunlight. Otherwise the packaging material may be deformed or CTVS may stick together, causing problems during mounting.
- Avoid contamination of the CTVS surface during storage, handling and processing.
- Avoid storing CTVS devices in harmful environments where they are exposed to corrosive gases for example (SO_x , Cl).
- Use CTVS as soon as possible after opening factory seals such as polyvinyl-sealed packages.
- Solder CTVS components after shipment from EPCOS within the time specified:
 - CTVS with Ni barrier termination, 12 months
 - CTVS with AgPd and AgPt termination, 6 months
 - SHCV and CU series, 24 months

Handling

- Do not drop CTVS components and allow them to be chipped.
- Do not touch CTVS with your bare hands - gloves are recommended.
- Avoid contamination of the CTVS surface during handling.

Mounting

- When CTVS devices are encapsulated with sealing material or overmolded with plastic material, electrical characteristics might be degraded and the life time reduced.
- Make sure an electrode is not scratched before, during or after the mounting process.
- Make sure contacts and housings used for assembly with CTVS components are clean before mounting.
- The surface temperature of an operating CTVS can be higher. Ensure that adjacent components are placed at a sufficient distance from a CTVS to allow proper cooling.
- Avoid contamination of the CTVS surface during processing.
- Multilayer varistors (MLVs) with AgPd termination are not approved for lead-free soldering.

Soldering

- Complete removal of flux is recommended to avoid surface contamination that can result in an instable and/or high leakage current.
- Use resin-type or non-activated flux.
- Bear in mind that insufficient preheating may cause ceramic cracks.
- Rapid cooling by dipping in solvent is not recommended, otherwise a component may crack.

SMD disk varistors (CU varistors)

Standard series

SMD

Conductive adhesive gluing

- Only multilayer varistors (MLVs) with an AgPd termination are approved for conductive adhesive gluing.

Operation

- Use CTVS only within the specified operating temperature range.
- Use CTVS only within specified voltage and current ranges.
- Environmental conditions must not harm a CTVS. Only use them in normal atmospheric conditions. Reducing the atmosphere (e.g. hydrogen or nitrogen atmosphere) is prohibited.
- Prevent a CTVS from contacting liquids and solvents. Make sure that no water enters a CTVS (e.g. through plug terminals).
- Avoid dewing and condensation.
- EPCOS CTVS components are mainly designed for encased applications. Under all circumstances avoid exposure to:
 - direct sunlight
 - rain or condensation
 - steam, saline spray
 - corrosive gases
 - atmosphere with reduced oxygen content
- EPCOS CTVS devices are not suitable for switching applications or voltage stabilization where static power dissipation is required.
- Multilayer varistors (MLVs) are designed for ESD protection and transient suppression. CeraDiodes are designed for ESD protection only, ESD/EMI filters are designed for ESD and EMI protection only.

This listing does not claim to be complete, but merely reflects the experience of EPCOS AG.

Important notes

The following applies to all products named in this publication:

1. Some parts of this publication contain **statements about the suitability of our products for certain areas of application**. These statements are based on our knowledge of typical requirements that are often placed on our products in the areas of application concerned. We nevertheless expressly point out **that such statements cannot be regarded as binding statements about the suitability of our products for a particular customer application**. As a rule, EPCOS is either unfamiliar with individual customer applications or less familiar with them than the customers themselves. For these reasons, it is always ultimately incumbent on the customer to check and decide whether an EPCOS product with the properties described in the product specification is suitable for use in a particular customer application.
2. We also point out that **in individual cases, a malfunction of electronic components or failure before the end of their usual service life cannot be completely ruled out in the current state of the art, even if they are operated as specified**. In customer applications requiring a very high level of operational safety and especially in customer applications in which the malfunction or failure of an electronic component could endanger human life or health (e.g. in accident prevention or lifesaving systems), it must therefore be ensured by means of suitable design of the customer application or other action taken by the customer (e.g. installation of protective circuitry or redundancy) that no injury or damage is sustained by third parties in the event of malfunction or failure of an electronic component.
3. **The warnings, cautions and product-specific notes must be observed.**
4. In order to satisfy certain technical requirements, **some of the products described in this publication may contain substances subject to restrictions in certain jurisdictions (e.g. because they are classed as hazardous)**. Useful information on this will be found in our Material Data Sheets on the Internet (www.epcos.com/material). Should you have any more detailed questions, please contact our sales offices.
5. We constantly strive to improve our products. Consequently, **the products described in this publication may change from time to time**. The same is true of the corresponding product specifications. Please check therefore to what extent product descriptions and specifications contained in this publication are still applicable before or when you place an order. We also **reserve the right to discontinue production and delivery of products**. Consequently, we cannot guarantee that all products named in this publication will always be available. The aforementioned does not apply in the case of individual agreements deviating from the foregoing for customer-specific products.
6. Unless otherwise agreed in individual contracts, **all orders are subject to the current version of the "General Terms of Delivery for Products and Services in the Electrical Industry" published by the German Electrical and Electronics Industry Association (ZVEI)**.
7. The trade names EPCOS, BAOKE, Alu-X, CeraDiode, CSMP, CSSP, CTVS, DeltaCap, DigiSiMic, DSSP, FormFit, MiniBlue, MiniCell, MKK, MKD, MLSC, MotorCap, PCC, PhaseCap, PhaseCube, PhaseMod, PhiCap, SIFERRIT, SIFI, SIKOREL, SilverCap, SIMDAD, SiMic, SIMID, SineFormer, SIOV, SIP5D, SIP5K, ThermoFuse, WindCap are **trademarks registered or pending** in Europe and in other countries. Further information will be found on the Internet at www.epcos.com/trademarks.