



Film Capacitors

Metallized Polypropylene Film Capacitors (MFP)

Series/Type: B32632 ... B32634

Date: August 2004

© EPCOS AG 2004. Reproduction, publication and dissemination of this data sheet, enclosures hereto and the information contained therein without EPCOS' prior express consent is prohibited.

Purchase orders are subject to the General Conditions for the Supply of Products and Services of the Electrical and Electronics Industry recommended by the ZVEI (German Electrical and Electronic Manufacturers' Association), unless otherwise agreed.

High pulse (wound)

Typical applications

- Smoothing
- High-frequency AC loads
- TV (flyback)

Climatic

- Max. operating temperature: 110 °C
- Climatic category (IEC 60068-1): 55/100/56

Construction

- Dielectric: polypropylene (PP)
- Film metallized on one side and metal foils internally connected in series
- Contact layer of sprayed metal
- Wound capacitor technology
- Epoxy resin coating (UL 94 V-0)

Features

- Highest possible contact reliability
- Very high pulse strength
- Self-healing properties

Terminals

- Crimped wire leads, lead-free tinned, lead length (6 – 1 mm) or min. 20 mm
- Double crimped wire leads, lead-free tinned
- Straight wire leads, lead-free tinned, lead length (17 ±3 mm)
- Different lead spacings (reduced and enlarged) available, lead length (6 – 1 mm)

Marking

Manufacturer's logo, style and type (P6xx),
rated capacitance (coded),
capacitance tolerance (code letter),
rated DC voltage, date of manufacture (coded)

Delivery mode

Bulk (untaped)
Taped (Ammo pack or reel)
For notes on taping, refer to chapter "Taping and packing".

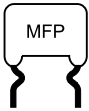

Dimensional drawings

Crimped leads

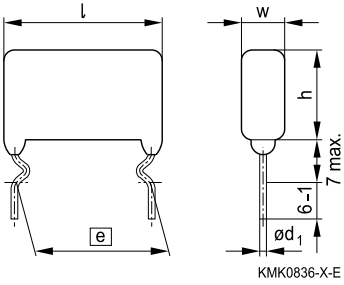

Double crimped leads

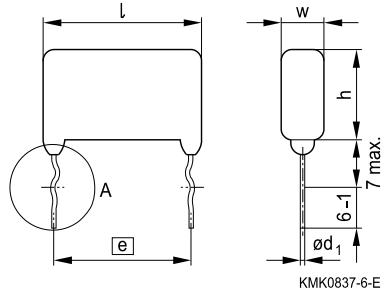

Straight leads

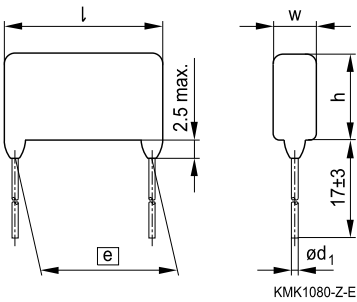

Detail of double crimped version

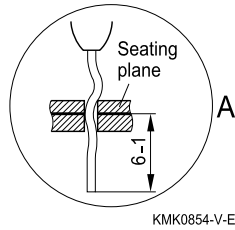

Dimensions in mm

Lead spacing	Lead diameter	Type
$e \pm 0.8$	d_1	
15.0	0.8	B32632
22.5	0.8	B32633
27.5	0.8	B32634

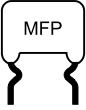





B32632 ... B32634

High pulse (wound)

Overview of available types

Lead spacing	15.0 mm					22.5 mm					
Type	B32632					B32633					
V_R (VDC)	630	1250	1600	2000	3000	630	1250	1600	2000	2500	3000
V_{rms} (VAC)	300	450	450	500	800	300	450	450	500	750	800
C_R (nF)											
0.47											
0.68											
1.0											
1.5											
2.2											
3.3											
4.7											
6.8											
10											
15											
22											
33											
47											
68											
100											



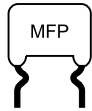

Lead configurations

Series	Standard	Reduced	Enlarged	Straight	Double crimped
					
B32632	15 mm	7.5 / 10 / 12.5 mm	17.5 mm	15 mm	15 mm
B32633	22.5 mm	15 / 17.5 / 20 mm	25 mm	22.5 mm	22.5 mm
B32634	27.5 mm	25 mm	–	27.5 mm	27.5 mm

Overview of available types

Lead spacing	27.5 mm			
Type	B32634			
V_R (VDC)	630	1250	1600	2000
V_{rms} (VAC)	300	450	450	500
C_R (nF)				
10				
15				
22				
33				
47				
68				
100				
150				
220				
330				

Lead configurations

Series	Standard	Reduced	Enlarged	Straight	Double crimped
					
B32632	15 mm	7.5 / 10 / 12.5 mm	17.5 mm	15 mm	15 mm
B32633	22.5 mm	15 / 17.5 / 20 mm	25 mm	22.5 mm	22.5 mm
B32634	27.5 mm	25 mm	–	27.5 mm	27.5 mm

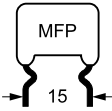
B32632
High pulse (wound)
Ordering codes and packing units (lead spacing 15 mm)

V_R	V_{rms} $f \leq 1$ kHz VAC	C_R nF	Max. dimensions $w \times h \times l$ mm	Ordering code (composition see below)	Ammo pack pcs./unit	Reel pcs./unit	Untaped pcs./unit
630	300	2.2	6.0 × 11.5 × 19.0	B32632A6222+***	900	1200	1000
		3.3	6.0 × 11.5 × 19.0	B32632A6332+***	900	1200	1000
		4.7	6.0 × 11.5 × 19.0	B32632A6472+***	900	1200	1000
		6.8	6.0 × 11.5 × 19.0	B32632A6682+***	900	1200	1000
		10	6.0 × 11.5 × 19.0	B32632A6103+***	900	1200	1000
		15	7.0 × 12.0 × 19.0	B32632A6153+***	800	1000	1000
		22	8.0 × 13.5 × 19.0	B32632A6223+***	700	900	1000
		33	9.5 × 15.5 × 19.0	B32632A6333+***	600	800	500
		47	12.0 × 17.0 × 19.0	B32632A6473+***	450	600	500
1250	450	1.0	6.5 × 11.5 × 19.0	B32632A7102+***	850	1100	1000
		1.5	6.5 × 11.5 × 19.0	B32632A7152+***	850	1100	1000
		2.2	6.5 × 12.0 × 19.0	B32632A7222+***	850	1100	1000
		3.3	7.0 × 12.5 × 19.0	B32632A7332+***	800	1000	1000
		4.7	7.0 × 12.5 × 19.0	B32632A7472+***	800	1000	1000
		6.8	7.5 × 14.0 × 19.0	B32632A7682+***	750	1000	1000
		10	9.0 × 15.5 × 19.0	B32632A7103+***	600	800	500
		15	12.0 × 16.5 × 19.0	B32632A7153+***	450	600	500
1600	450	1.0	6.0 × 11.5 × 19.0	B32632A1102+***	900	1200	1000
		1.5	6.0 × 11.5 × 19.0	B32632A1152+***	900	1200	1000
		2.2	7.0 × 12.0 × 19.0	B32632A1222+***	800	1000	1000
		3.3	8.0 × 13.5 × 19.0	B32632A1332+***	700	900	1000
		4.7	9.5 × 15.5 × 19.0	B32632A1472+***	600	800	1000
		6.8	10.5 × 16.0 × 19.0	B32632A1682+***	500	700	500
		10	12.5 × 17.5 × 19.0	B32632A1103+***	450	600	500

Further E series and intermediate capacitance values on request.

Composition of ordering code

+ = Capacitance tolerance code:

K = ±10%

J = ±5%

A = ±3.5%

on request = ±2.5%

*** = Packaging code:

289 = Ammo pack

189 = Reel

010 = Untaped crimped (lead length 6 – 1 mm)

011 = Untaped crimped (lead length min. 20 mm)

008 = Untaped (straight, lead length 17±3 mm)

020 = Double crimped (lead length 6 – 1 mm)

Packaging codes for further lead configurations (untaped):

Lead configuration (lead length 6 – 1 mm)	Reduced	Reduced	Reduced	Enlarged
Lead spacing (mm)	7.5 mm	10 mm	12.5 mm	17.5 mm
Packaging code	030	040	050	060

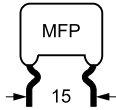
Ordering codes and packing units (lead spacing 15 mm)

V_R	V_{rms} $f \leq 1$ kHz VAC	C_R nF	Max. dimensions $w \times h \times l$ mm	Ordering code (composition see below)	Ammo pack pcs./unit	Reel pcs./unit	Untaped pcs./unit
2000	500	0.47	$6.5 \times 11.5 \times 19.0$	B32632A2471M***	850	1100	1000
		0.47	$6.5 \times 11.5 \times 19.0$	B32632A2471K***	850	1100	1000
		0.68	$6.5 \times 12.5 \times 19.0$	B32632A2681M***	850	1100	1000
		0.68	$6.5 \times 12.5 \times 19.0$	B32632A2681K***	850	1100	1000
		1.0	$6.5 \times 12.5 \times 19.0$	B32632A2102+***	850	1100	1000
		1.5	$6.5 \times 12.5 \times 19.0$	B32632A2152+***	850	1100	1000
		2.2	$7.0 \times 13.5 \times 19.0$	B32632A2222+***	800	1000	500
		3.3	$8.5 \times 15.0 \times 19.0$	B32632A2332+***	650	850	500
		4.7	$10.5 \times 16.0 \times 19.0$	B32632A2472+***	500	700	500
		6.8	$12.5 \times 17.5 \times 19.0$	B32632A2682+***	450	600	500
3000	800	0.47	$5.5 \times 11.0 \times 19.0$	B32632S4471+***	1000	1300	1000
		0.68	$6.0 \times 12.0 \times 19.0$	B32632S4681+***	900	1200	1000
		1.0	$7.5 \times 13.0 \times 19.0$	B32632S4102+***	750	1000	500
		1.5	$8.5 \times 14.5 \times 19.0$	B32632S4152+***	650	850	500
		2.2	$10.5 \times 16.0 \times 19.0$	B32632S4222+***	500	700	500
		3.3	$12.5 \times 18.0 \times 19.0$	B32632S4332+***	450	600	500

Further E series and intermediate capacitance values on request.

Composition of ordering code

+ = Capacitance tolerance code:

K = $\pm 10\%$
 J = $\pm 5\%$
 A = $\pm 3.5\%$
 on request = $\pm 2.5\%$

*** = Packaging code:

289 = Ammo pack
 189 = Reel
 010 = Untaped crimped (lead length 6 – 1 mm)
 011 = Untaped crimped (lead length min. 20 mm)
 008 = Untaped (straight, lead length 17 ± 3 mm)
 020 = Double crimped (lead length 6 – 1 mm)

Packaging codes for further lead configurations (untaped):

Lead configuration (lead length 6 – 1 mm)	Reduced	Reduced	Reduced	Enlarged
Lead spacing (mm)	7.5 mm	10 mm	12.5 mm	17.5 mm
Packaging code	030	040	050	060

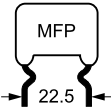
B32633
High pulse (wound)
Ordering codes and packing units (lead spacing 22.5 mm)

V_R VDC	V_{rms} $f \leq 1$ kHz VAC	C_R nF	Max. dimensions $w \times h \times l$ mm	Ordering code (composition see below)	Ammo pack pcs./unit	Reel pcs./unit	Untaped pcs./unit
630	300	22	$6.5 \times 12.5 \times 27.5$	B32633A6223+***	550	750	1000
		33	$7.0 \times 15.0 \times 27.5$	B32633A6333+***	500	700	500
		47	$8.0 \times 17.0 \times 27.5$	B32633A6473+***	450	600	500
		68	$9.5 \times 17.5 \times 27.5$	B32633A6683+***	350	500	500
		100	$11.5 \times 19.5 \times 27.5$	B32633A6104+***	300	400	250
1250	450	10	$7.0 \times 15.0 \times 27.5$	B32633A7103+***	500	700	500
		15	$8.0 \times 16.0 \times 27.5$	B32633A7153+***	450	600	500
		22	$10.0 \times 17.5 \times 27.5$	B32633A7223+***	350	500	500
		33	$12.0 \times 19.5 \times 27.5$	B32633A7333+***	300	400	250
		47	$14.0 \times 21.0 \times 27.5$	B32633A7473+***	250	350	250
1600	450	3.3	$7.0 \times 13.0 \times 27.5$	B32633A1332+***	500	700	1000
		4.7	$7.0 \times 13.0 \times 27.5$	B32633A1472+***	500	700	1000
		6.8	$7.0 \times 16.0 \times 27.5$	B32633A1682+***	500	700	500
		10	$8.0 \times 17.0 \times 27.5$	B32633A1103+***	450	650	500
		15	$9.5 \times 17.5 \times 27.5$	B32633A1153+***	350	500	250
		22	$11.5 \times 19.5 \times 27.5$	B32633A1223+***	300	400	250
		33	$15.5 \times 22.5 \times 27.5$	B32633A1333+***	250	300	250
2000	500	2.2	$7.0 \times 14.0 \times 27.5$	B32633A2222+***	500	700	1000
		3.3	$7.0 \times 14.0 \times 27.5$	B32633A2332+***	500	700	1000
		4.7	$7.0 \times 15.5 \times 27.5$	B32633A2472+***	500	700	500
		6.8	$9.0 \times 16.5 \times 27.5$	B32633A2682+***	400	550	500
		10	$10.5 \times 17.5 \times 27.5$	B32633A2103+***	350	450	250
		15	$13.0 \times 20.5 \times 27.5$	B32633A2153+***	250	350	250
		22	$15.5 \times 22.5 \times 27.5$	B32633A2223+***	200	300	250

Further E series and intermediate capacitance values on request.

Composition of ordering code

+ = Capacitance tolerance code:

K = $\pm 10\%$
 J = $\pm 5\%$
 A = $\pm 3.5\%$
 on request = $\pm 2.5\%$

*** = Packaging code:

289 = Ammo pack
 189 = Reel
 010 = Untaped crimped (lead length 6 – 1 mm)
 011 = Untaped crimped (lead length min. 20 mm)
 008 = Untaped (straight, lead length 17 ± 3 mm)
 020 = Double crimped (lead length 6 – 1 mm)

Packaging codes for further lead configurations (untaped):

Lead configuration (lead length 6 – 1 mm)	Reduced	Reduced	Reduced	Enlarged
Lead spacing (mm)	15 mm	17.5 mm	20 mm	25 mm
Packaging code	055	060	070	080

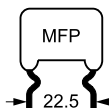
Ordering codes and packing units (lead spacing 22.5 mm)

V_R	V_{rms} $f \leq 1$ kHz VAC	C_R nF	Max. dimensions $w \times h \times l$ mm	Ordering code (composition see below)	Ammo pack pcs./unit	Reel pcs./unit	Untaped pcs./unit
2500	750	1.0	$7.5 \times 14.0 \times 27.5$	B32633A3102+***	450	650	1000
		1.5	$7.5 \times 15.0 \times 27.5$	B32633A3152+***	450	650	1000
		2.2	$8.0 \times 16.0 \times 27.5$	B32633A3222+***	450	600	500
		3.3	$9.5 \times 16.0 \times 27.5$	B32633A3332+***	350	500	500
		4.7	$10.0 \times 18.5 \times 27.5$	B32633A3472+***	350	500	500
		6.8	$12.0 \times 20.5 \times 27.5$	B32633A3682+***	300	400	250
		10	$14.0 \times 23.0 \times 27.5$	B32633A3103+***	250	350	250
		15	$17.0 \times 26.0 \times 27.5$	B32633A3153+***	200	300	200
3000	800	1.0	$5.5 \times 12.0 \times 27.5$	B32633S4102+***	650	900	500
		1.5	$6.5 \times 12.5 \times 27.5$	B32633S4152+***	550	750	500
		2.2	$7.5 \times 14.0 \times 27.5$	B32633S4222+***	450	650	500
		3.3	$9.0 \times 15.5 \times 27.5$	B32633S4332+***	400	550	500
		4.7	$11.0 \times 17.0 \times 27.5$	B32633S4472+***	300	450	500
		6.8	$13.0 \times 19.0 \times 27.5$	B32633S4682+***	250	350	200

Further E series and intermediate capacitance values on request.

Composition of ordering code

+ = Capacitance tolerance code:

K = $\pm 10\%$

J = $\pm 5\%$

A = $\pm 3.5\%$

on request = $\pm 2.5\%$

*** = Packaging code:

289 = Ammo pack

189 = Reel

010 = Untaped crimped (lead length 6 – 1 mm)

011 = Untaped crimped (lead length min. 20 mm)

008 = Untaped (straight, lead length 17 ± 3 mm)

020 = Double crimped (lead length 6 – 1 mm)

Packaging codes for further lead configurations (untaped):

Lead configuration (lead length 6 – 1 mm)	Reduced	Reduced	Reduced	Enlarged
Lead spacing (mm)	15 mm	17.5 mm	20 mm	25 mm
Packaging code	055	060	070	080

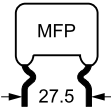
B32634
High pulse (wound)
Ordering codes and packing units (lead spacing 27.5 mm)

V_R	V_{rms} $f \leq 1$ kHz	C_R	Max. dimensions $w \times h \times l$ mm	Ordering code (composition see below)	Untaped pcs./unit
VDC	VAC	nF			
630	300	100	9.5 × 18.0 × 32.5	B32634A6104+***	250
		150	12.0 × 22.0 × 32.5	B32634A6154+***	200
		220	13.5 × 22.5 × 32.5	B32634A6224+***	200
		330	16.0 × 25.5 × 32.5	B32634A6334+***	150
1250	450	33	9.5 × 18.0 × 32.5	B32634A7333+***	250
		47	11.5 × 20.0 × 32.5	B32634A7473+***	250
		68	13.0 × 23.0 × 32.5	B32634A7683+***	200
		100	16.0 × 26.0 × 32.5	B32634A7104+***	150
1600	450	15	8.5 × 17.0 × 32.5	B32634A1153+***	500
		22	10.0 × 18.5 × 32.5	B32634A1223+***	250
		33	12.0 × 22.0 × 32.5	B32634A1333+***	250
		47	14.0 × 22.5 × 32.5	B32634A1473+***	200
		68	16.0 × 25.5 × 32.5	B32634A1683+***	150
2000	500	10	8.5 × 17.0 × 32.5	B32634A2103+***	500
		15	10.0 × 20.0 × 32.5	B32634A2153+***	250
		22	12.0 × 22.0 × 32.5	B32634A2223+***	250
		33	15.0 × 25.0 × 32.5	B32634A2333+***	200

Further E series and intermediate capacitance values on request.

Composition of ordering code

+ = Capacitance tolerance code:

K = ±10%
 J = ±5%
 A = ±3.5%
 on request = ±2.5%

*** = Packaging code:

010 = Untaped crimped (lead length 6 – 1 mm)
 011 = Untaped crimped (lead length min. 20 mm)
 008 = Untaped (straight, lead length 17±3 mm)
 020 = Double crimped (lead length 6 – 1 mm)

Packaging codes for further lead configurations (untaped):

Lead configuration (lead length 6 – 1 mm)	Reduced
Lead spacing (mm)	25 mm
Packaging code	090

Technical data

Operating temperature range	Max. operating temperature $T_{op,max}$	+110 °C	
	Upper category temperature T_{max}	+100 °C	
	Lower category temperature T_{min}	-55 °C	
	Rated temperature T_R	+85 °C	
Dissipation factor $\tan \delta$ at 20 °C (upper limit values)	1.0 · 10 ⁻³ (at 10 kHz)		
	2.0 · 10 ⁻³ (at 100 kHz)		
Insulation resistance R_{ins} at 20 °C, rel. humidity ≤ 65% (minimum as-delivered values)	100 GΩ		
DC test voltage	2.0 · V_R , 2 s		
Category voltage V_C (continuous operation with V_{DC} or V_{AC} at $f \leq 1$ kHz)	T_A (°C)	DC voltage derating	AC voltage derating
	$T_A \leq 85$ $85 < T_A \leq 100$	$V_C = V_R$ $V_C = V_R \cdot (165 - T_A) / 80$	$V_{C,rms} = V_{rms}$ $V_{C,rms} = V_{rms} \cdot (165 - T_A) / 80$
Operating voltage V_{op} for short operating periods (V_{DC} or V_{AC} at $f \leq 1$ kHz)	T_A (°C)	DC voltage (max. hours)	AC voltage (max. hours)
	$T_A \leq 85$ $85 < T_A \leq 100$	$V_{op} = 1.25 \cdot V_C$ (2000h) $V_{op} = 1.25 \cdot V_C$ (1000h)	$V_{op} = 1.0 \cdot V_{C,rms}$ (2000h) $V_{op} = 1.0 \cdot V_{C,rms}$ (1000h)
Damp heat test Limit values after damp heat test	56 days/40 °C/93% relative humidity		
	Capacitance change $ \Delta C/C $	≤ 2%	
	Dissipation factor change $\Delta \tan \delta$	≤ 1.0 · 10 ⁻³ (at 10 kHz)	
	Insulation resistance R_{ins}	≥ 50% of minimum as-delivered values	
Reliability: Failure rate λ Service life t_{SL}	2 fit (≤ 2 · 10 ⁻⁹ /h) at 0.5 · V_R , 40 °C 200 000 h at 1.0 · V_R , 40 °C For conversion to other operating conditions and temperatures, refer to chapter "Quality assurance", page .		
Failure criteria: Total failure Failure due to variation of parameters	Short circuit or open circuit		
	Capacitance change $ \Delta C/C $	> 10%	
	Dissipation factor $\tan \delta$	> 4 · upper limit value	
	Insulation resistance R_{ins}	< 1500 MΩ	

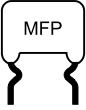

B32632 ... B32634

High pulse (wound)

Characteristic voltages V_{DC} , V_{AC} , V_{pp}

V_{DC} V	V_{AC} V	V_{pp} V
630	300	560
1250	450	1000
1600	450	1200
2000	500	1400
2500	750	1750
3000	800	1800

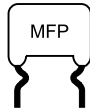

Pulse handling capability

"dV/dt" represents the maximum permissible voltage change per unit of time for non-sinusoidal voltages, expressed in V/μs.

"k₀" represents the maximum permissible pulse characteristic of the waveform applied to the capacitor, expressed in V²/μs.

Note:

The values of dV/dt and k₀ provided below must not be exceeded in order to avoid damaging the capacitor.

dV/dt values

Lead spacing		15 mm	22.5 mm	27.5 mm
V _R VDC	V _{rms} VAC	dV/dt in V/μs		
630	300	5 000	3 000	2 000
1250	450	12 000	7 000	4 500
1600	450	14 000	9 000	5 500
2000	500	17 000	12 000	7 000
2500	750	–	14 000	–
3000	800	18 000	15 000	–

k₀ values

Lead spacing		15 mm	22.5 mm	27.5 mm
V _R VDC	V _{rms} VAC	k ₀ in V ² /μs		
630	300	6 300 000	3 800 000	2 500 000
1250	450	30 000 000	17 500 000	11 000 000
1600	450	45 000 000	29 000 000	17 500 000
2000	500	68 000 000	48 000 000	28 000 000
2500	750	–	59 000 000	–
3000	800	108 000 000	90 000 000	–

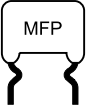

B32632 ... B32634

High pulse (wound)

Impedance Z versus frequency f
(typical values)

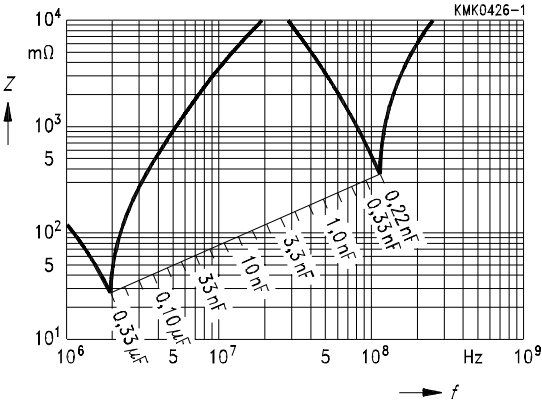

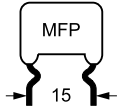

Permissible AC voltage V_{rms} versus frequency f (for sinusoidal waveforms, $T_A \leq 90^\circ C$)
 For $T_A > 90^\circ C$, please refer to "General technical information", section 3.2.3.

Lead spacing 15 mm

630 VDC/300 VAC

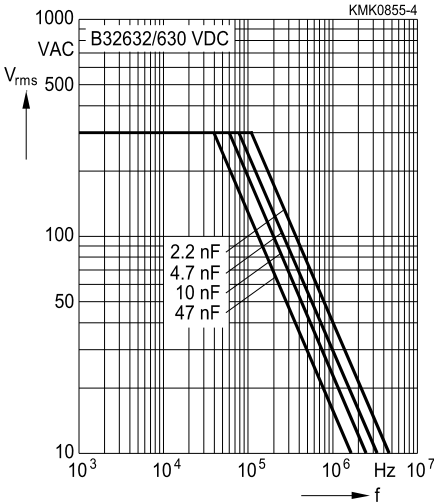

1250 VDC/450 VAC

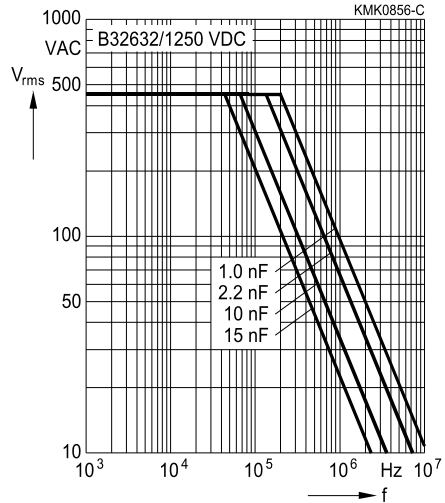

1600 VDC/450 VAC

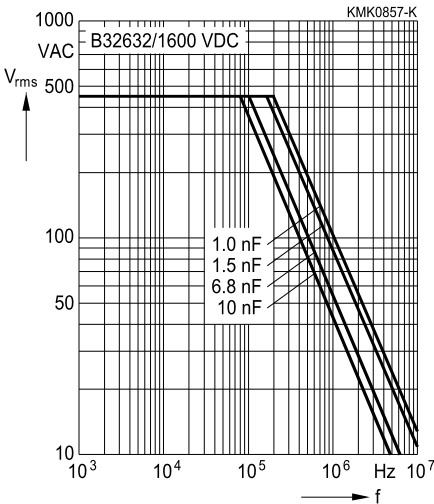

2000 VDC/500 VAC

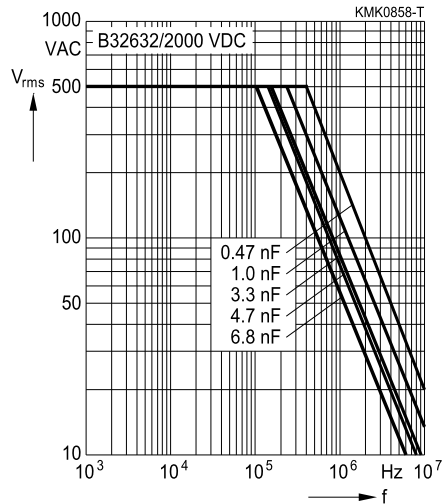

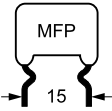

B32632

High pulse (wound)

Permissible AC voltage V_{rms} versus frequency f (for sinusoidal waveforms, $T_A \leq 90^\circ\text{C}$)

For $T_A > 90^\circ\text{C}$, please refer to "General technical information", section 3.2.3.

Lead spacing 15 mm

3000 VDC/800 VAC

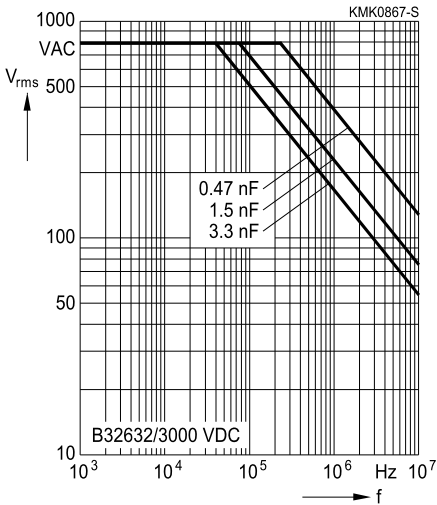

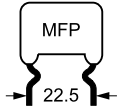

Permissible AC voltage V_{rms} versus frequency f (for sinusoidal waveforms, $T_A \leq 90^\circ C$)
 For $T_A > 90^\circ C$, please refer to "General technical information", section 3.2.3.

Lead spacing 22.5 mm

630 VDC/300 VAC

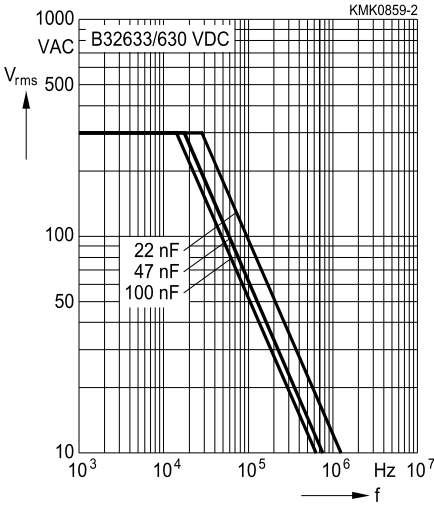

1250 VDC/450 VAC

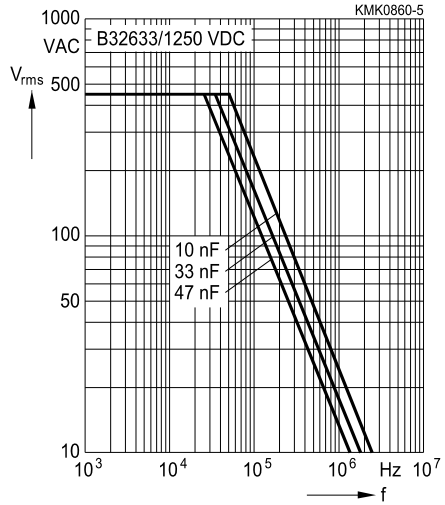

1600 VDC/450 VAC

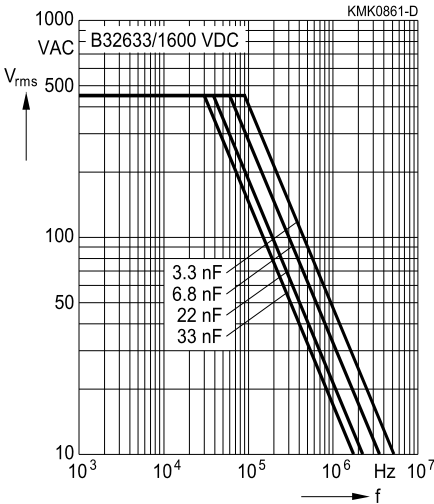

2000 VDC/500 VAC

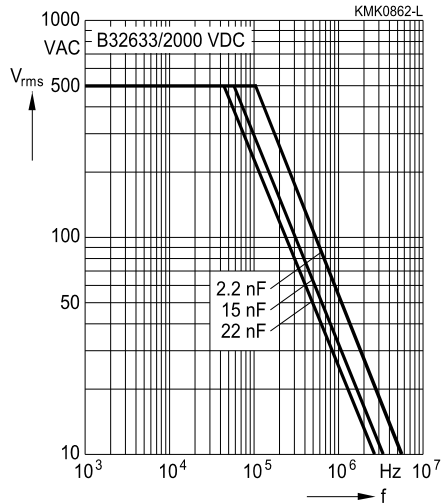

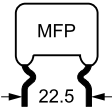

B32633

High pulse (wound)

Permissible AC voltage V_{rms} versus frequency f (for sinusoidal waveforms, $T_A \leq 90^\circ\text{C}$)

For $T_A > 90^\circ\text{C}$, please refer to "General technical information", section 3.2.3.

Lead spacing 22.5 mm

2500 VDC/750 VAC

3000 VDC/800 VAC

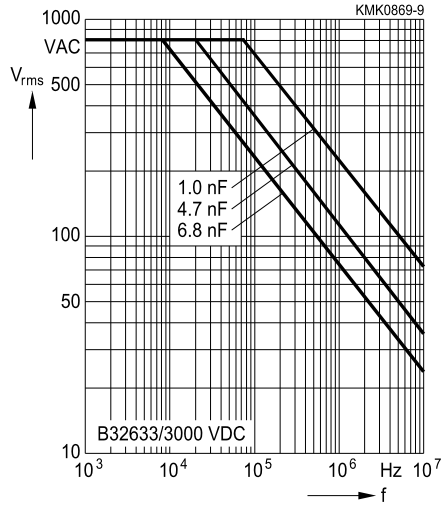
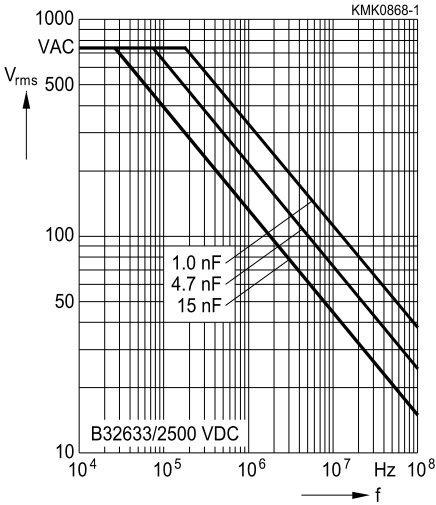

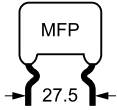

Permissible AC voltage V_{rms} versus frequency f (for sinusoidal waveforms, $T_A \leq 90^\circ C$)
 For $T_A > 90^\circ C$, please refer to "General technical information", section 3.2.3.

Lead spacing 27.5 mm

630 VDC/300 VAC

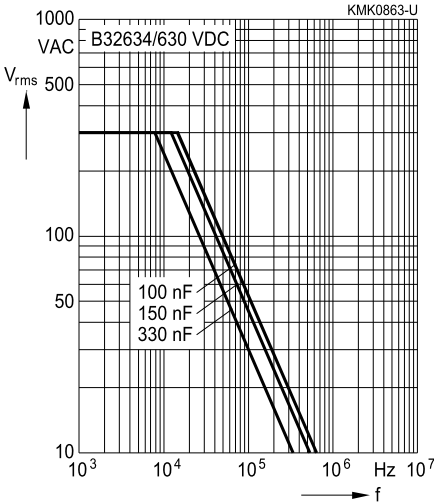

1250 VDC/450 VAC

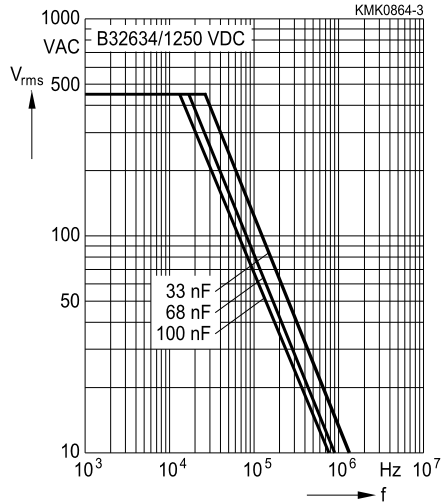

1600 VDC/450 VAC

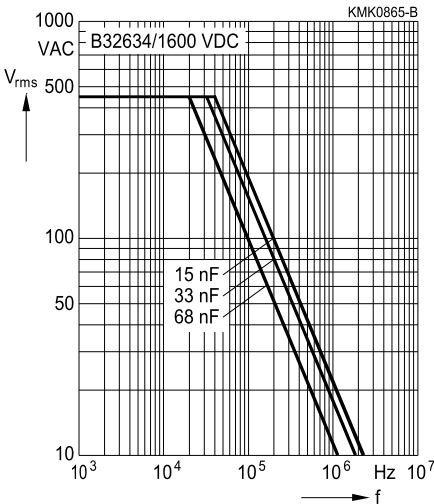

2000 VDC/500 VAC

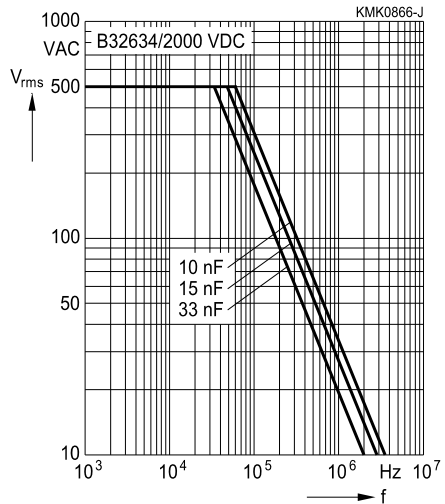

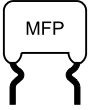

B32632 ... B32634

High pulse (wound)

Flyback application

Permissible voltage and current / waveform

Permissible current I_{pp} versus frequency for a duty cycle of 20% ($t_0/t = 0.2$):

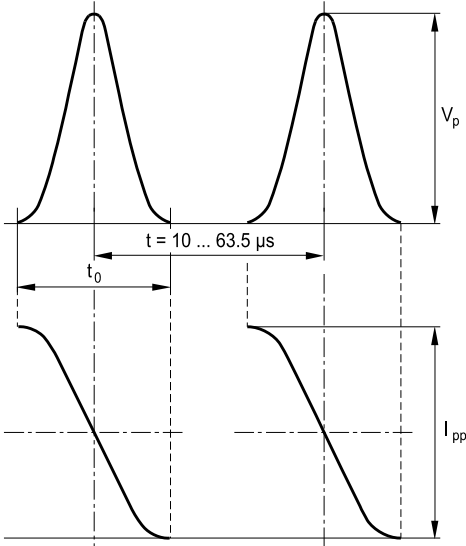

KMK0720-5

Approximation formular for duty cycle higher than 20%:

$$I'_{pp} = I_{pp} \cdot \sqrt{\frac{t_0^3}{t^3}}$$

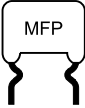

Flyback application

Permissible current I_{pp} versus rated capacitance C_R

Frequency = 15.75 kHz

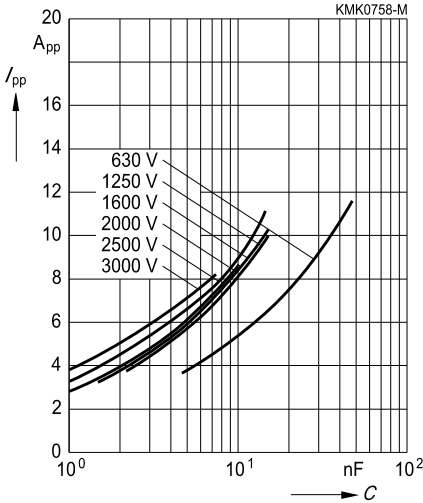

Frequency = 31.5 kHz

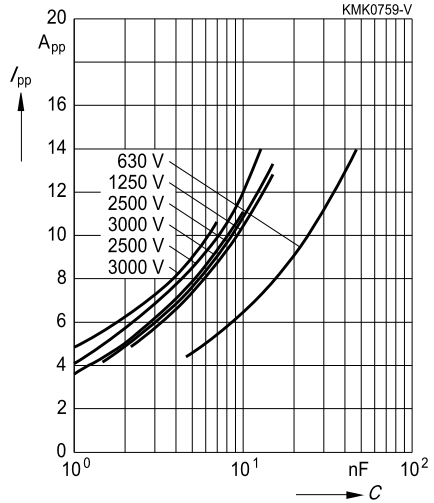

Frequency = 95 kHz

