



## SMT inductors

SIMID series, SIMID 1210-100

**Series/Type:** B82422A\*100

**Date:** October 2012

© EPCOS AG 2015. Reproduction, publication and dissemination of this publication, enclosures hereto and the information contained therein without EPCOS' prior express consent is prohibited.

EPCOS AG is a TDK Group Company.

### SMD

**Size 1210 (EIA) or 3225 (IEC)**  
**Rated inductance 0.0082 ... 100  $\mu$ H**  
**Rated current 65 ... 800 mA**



#### Construction

- Ceramic or ferrite core
- Laser-welded winding
- Flame-retardant molding

#### Features

- Temperature range up to +145 °C
- High Q factor
- High resonance frequency
- Qualified to AEC-Q200
- Suitable for lead-free reflow soldering as referenced in JEDEC J-STD 020D
- RoHS-compatible

#### Applications

- Filtering of supply voltages, coupling, decoupling
- Antenna systems
- Automotive electronics
- Telecommunications
- Consumer and data processing equipment
- Industrial electronics

#### Terminals

- Base material CuSn6
- Layer composition Cu, Ag, Sn (lead-free)<sup>1)</sup>
- Electro-plated

#### Marking

- Marking on component:  
 Manufacturer, L value (in nH),  
 tolerance of L value (coded), date of manufacture (YWWD)
- Minimum data on reel:  
 Manufacturer, ordering code, L value,  
 quantity, date of packing

#### Delivery mode and packing units

- 8-mm blister tape, wound on 180-mm or 330-mm  $\varnothing$  reel
- Packing units:  
 180-mm reel: 2000 pcs./reel  
 330-mm reel: 8000 pcs./reel

1) Ni-barrier-plated terminals on request (B82422A\*150).

**SIMID 1210-100**

**SMD**

**Dimensional drawing and layout recommendation**

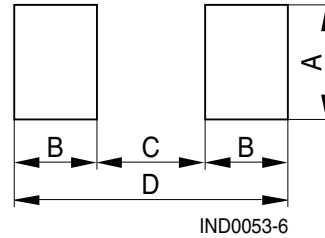

A	B	C	D
2.7	1.15	2.1	4.4

1) Soldering area

IND0073-6-E

Dimensions in mm

**Taping and packing**

**Blister tape**

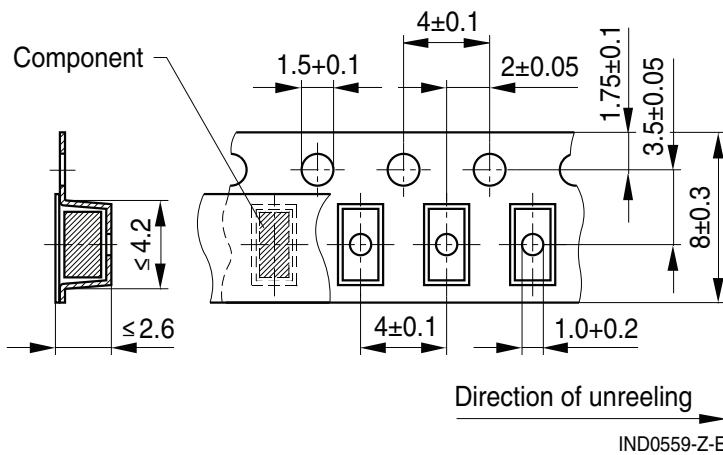

IND0559-Z-E

**Reel**

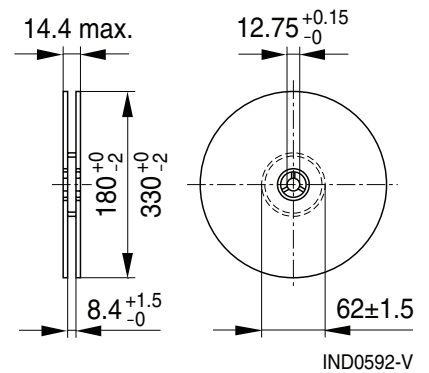

IND0592-V

Dimensions in mm

**SMD**
**Technical data and measuring conditions**

Rated inductance $L_R$	Measured with impedance analyzer Agilent 4294A at frequency $f_L$ , 0.1 V, +20 °C
Q factor $Q_{min}$	Measured with impedance analyzer Agilent 4294A at frequency $f_Q$ , +20 °C
Rated temperature $T_R$	+125 °C
Rated current $I_R$	Maximum permissible DC with inductance decrease $\Delta L/L_0 \leq 10\%$ and temperature increase of $\leq 20$ K at rated temperature
Self-resonance frequency $f_{res,min}$	Measured with impedance analyzer Agilent E4991A / network analyzer Agilent E8362B, +20 °C
DC resistance $R_{max}$	Measured at +20 °C
Solderability (lead-free)	Sn95.5Ag3.8Cu0.7: +(245 ±5) °C, (5 ±0.3) s Wetting of soldering area $\geq 90\%$ (based on IEC 60068-2-58)
Resistance to soldering heat	+260 °C, 40 s (as referenced in JEDEC J-STD 020D)
Climatic category	55/125/56 (to IEC 60068-1)
Storage conditions	Mounted: -55 °C ... +125 °C Packaged: -25 °C ... +40 °C, $\leq 75\%$ RH
Weight	Approx. 50 mg

**SMD**
**Characteristics and ordering codes**

$L_R$ $\mu\text{H}$	Tolerance	$f_L$ MHz	$Q_{\min}$	$f_Q$ MHz	$I_R$ mA	$R_{\max}$ $\Omega$	$f_{\text{res, min}}$ MHz	Ordering code <sup>1)2)</sup> ( $\varnothing$ 180-mm reel)
Core material: ceramic								
0.0082	$\pm 5\% \triangleq J$	10	20	100	800	0.08	4000	B82422A3829+100
0.010	$\pm 10\% \triangleq K$	10	20	100	750	0.09	4000	B82422A3100+100
0.012		10	25	100	700	0.10	3500	B82422A3120+100
0.015		10	27	100	640	0.12	3000	B82422A3150+100
0.018		10	30	100	640	0.12	2500	B82422A3180+100
0.022		10	30	100	600	0.14	2500	B82422A3220+100
0.027		10	23	50	600	0.14	1850	B82422A3270+100
0.033		10	20	50	540	0.17	1700	B82422A3330+100
0.039		10	25	50	530	0.18	1450	B82422A3390+100
0.047		10	26	50	510	0.19	1350	B82422A3470+100
0.056		10	26	50	500	0.20	1200	B82422A3560+100
0.068		10	27	50	480	0.21	1150	B82422A3680+100
0.082		10	27	50	450	0.24	1050	B82422A3820+100
0.10		10	25	50	440	0.26	1000	B82422A3101+100
0.12		1	22	30	400	0.32	880	B82422A3121+100
0.15		1	25	30	390	0.33	850	B82422A3151+100
0.18		1	25	30	360	0.38	800	B82422A3181+100
0.22		1	25	30	280	0.64	700	B82422A3221+100
0.27		1	20	30	235	0.90	650	B82422A3271+100
0.33		1	22	30	200	1.3	580	B82422A3331+100
0.39		1	22	30	190	1.4	540	B82422A3391+100
0.47		1	22	30	150	2.2	480	B82422A3471+100
0.56		1	22	30	150	2.2	400	B82422A3561+100
0.68		1	22	30	145	2.4	280	B82422A3681+100
0.82		1	22	30	140	2.5	240	B82422A3821+100

Closer tolerances and special versions on request.

Higher currents possible at temperatures  $<T_R$  on request.

Sample kit available. Ordering code: B82422X100

For more information refer to chapter "Sample kits".

1) Replace the + by the code letter for the required inductance tolerance.

For reel size  $\varnothing$  330 mm the last digit has to be an »8«. Example: B82422A3829K108

2) For Ni-barrier-plated terminals replace the last three digits "100" by "150" (reel 180 mm) or "158" (reel 330 mm).

**SMD**
**Characteristics and ordering codes**

$L_R$ $\mu\text{H}$	Tolerance	$f_L$ MHz	$Q_{\min}$	$f_Q$ MHz	$I_R$ mA	$R_{\max}$ $\Omega$	$f_{\text{res, min}}$ MHz	Ordering code <sup>1)2)</sup> ( $\varnothing$ 180-mm reel)
Core material: ferrite								
1.0	$\pm 5\% \triangleq J$	1	20	7.96	380	0.34	320	B82422A1102+100
1.2	$\pm 10\% \triangleq K$	1	20	7.96	370	0.37	300	B82422A1122+100
1.5		1	20	7.96	340	0.50	270	B82422A1152+100
1.8		1	25	7.96	290	0.60	250	B82422A1182+100
2.2		1	25	7.96	270	0.75	125	B82422A1222+100
2.7		1	25	7.96	240	0.88	110	B82422A1272+100
3.3		1	27	7.96	200	1.20	110	B82422A1332+100
3.9		1	27	7.96	190	1.40	110	B82422A1392+100
4.7		1	27	7.96	150	2.20	110	B82422A1472+100
5.6		1	27	7.96	140	2.60	100	B82422A1562+100
6.8		1	27	7.96	135	2.80	90	B82422A1682+100
8.2		1	27	7.96	130	3.00	90	B82422A1822+100
10		1	27	2.52	180	1.60	25	B82422A1103+100
12		0.1	27	2.52	175	1.65	23	B82422A1123+100
15		0.1	27	2.52	165	1.85	20	B82422A1153+100
18		0.1	27	2.52	155	2.00	17	B82422A1183+100
22		0.1	27	2.52	140	2.65	16	B82422A1223+100
27		0.1	27	2.52	120	3.70	15	B82422A1273+100
33		0.1	27	2.52	105	4.50	13	B82422A1333+100
39		0.1	27	2.52	90	6.30	12	B82422A1393+100
47		0.1	27	2.52	85	7.00	11	B82422A1473+100
56		0.1	27	2.52	85	6.75	9	B82422A1563+100
68		0.1	27	2.52	80	7.70	9	B82422A1683+100
82		0.1	27	2.52	70	10.0	8	B82422A1823+100
100		0.1	27	2.52	65	11.5	7	B82422A1104+100

Closer tolerances and special versions on request.

Higher currents possible at temperatures  $<T_R$  on request.

Sample kit available. Ordering code: B82422X100

For more information refer to chapter "Sample kits".

1) Replace the + by the code letter for the required inductance tolerance.

For reel size  $\varnothing$  330 mm the last digit has to be an »8«. Example: B82422A1104K108

2) For Ni-barrier-plated terminals replace the last three digits "100" by "150" (reel 180 mm) or "158" (reel 330 mm).

**SMD**

**Impedance |Z| versus frequency f**  
measured with impedance analyzer Agilent E4991A, typical values at +20 °C

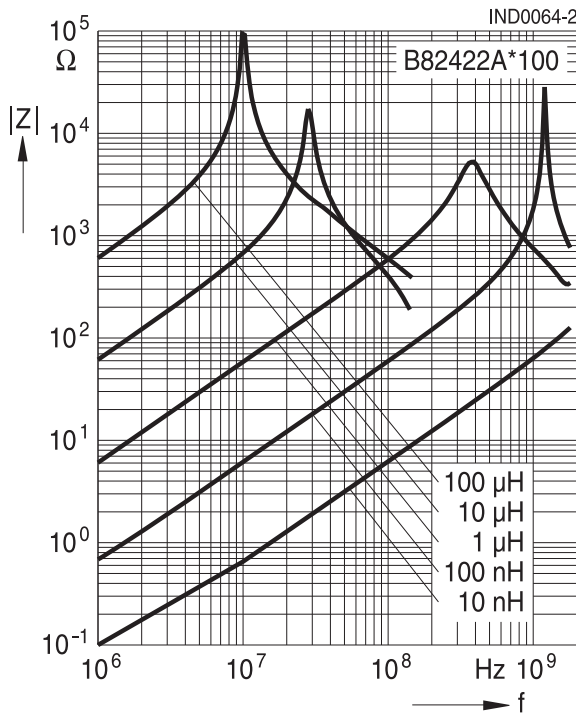

**Inductance L versus DC load current I<sub>DC</sub>**  
measured with LCR meter Agilent 4285A, typical values at +20 °C

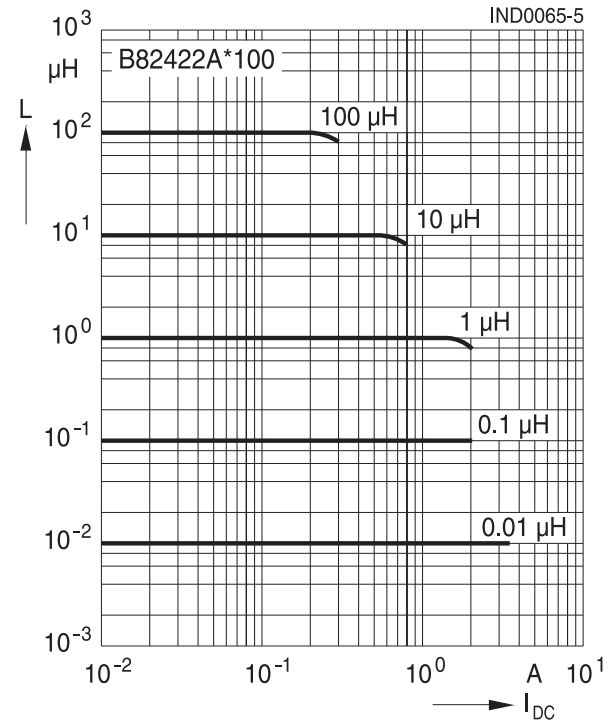

**Q factor versus frequency f**  
measured with impedance analyzer Agilent E4991A, typical values at +20 °C

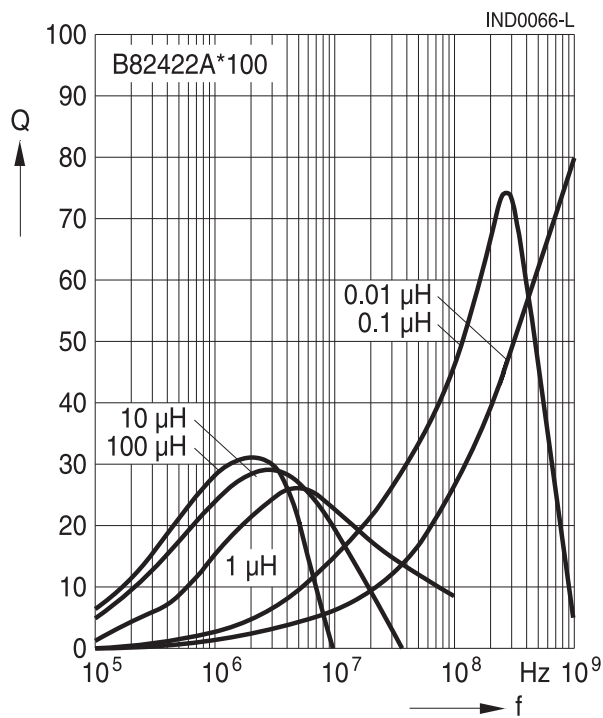

**Current derating I<sub>op</sub>/I<sub>R</sub> versus ambient temperature T<sub>A</sub>**  
(rated temperature T<sub>R</sub> = +125 °C)

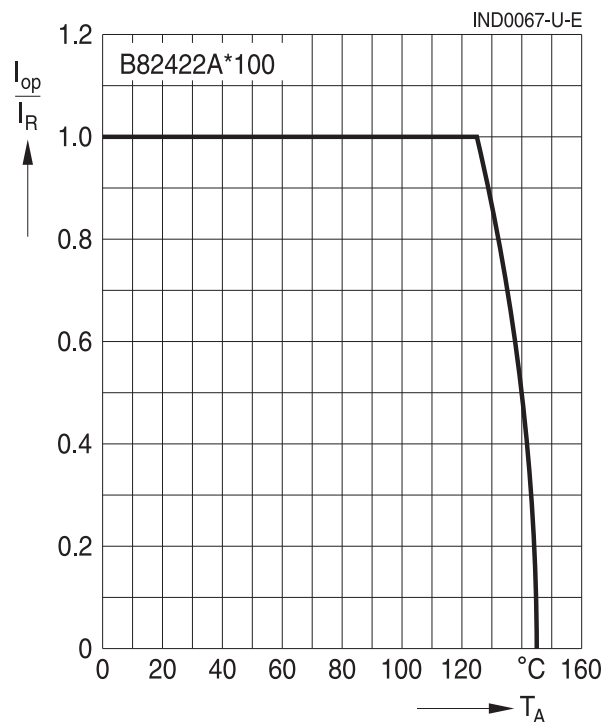

## Cautions and warnings

- Please note the recommendations in our Inductors data book (latest edition) and in the data sheets.
  - Particular attention should be paid to the derating curves given there.
  - The soldering conditions should also be observed. Temperatures quoted in relation to wave soldering refer to the pin, not the housing.
- If the components are to be washed varnished it is necessary to check whether the washing varnish agent that is used has a negative effect on the wire insulation, any plastics that are used, or on glued joints. In particular, it is possible for washing varnish agent residues to have a negative effect in the long-term on wire insulation.  
Washing processes may damage the product due to the possible static or cyclic mechanical loads (e.g. ultrasonic cleaning). They may cause cracks to develop on the product and its parts, which might lead to reduced reliability or lifetime.
- The following points must be observed if the components are potted in customer applications:
  - Many potting materials shrink as they harden. They therefore exert a pressure on the plastic housing or core. This pressure can have a deleterious effect on electrical properties, and in extreme cases can damage the core or plastic housing mechanically.
  - It is necessary to check whether the potting material used attacks or destroys the wire insulation, plastics or glue.
  - The effect of the potting material can change the high-frequency behaviour of the components.
- Ferrites are sensitive to direct impact. This can cause the core material to flake, or lead to breakage of the core.
- Even for customer-specific products, conclusive validation of the component in the circuit can only be carried out by the customer.



## Important notes

The following applies to all products named in this publication:

1. Some parts of this publication contain **statements about the suitability of our products for certain areas of application**. These statements are based on our knowledge of typical requirements that are often placed on our products in the areas of application concerned. We nevertheless expressly point out **that such statements cannot be regarded as binding statements about the suitability of our products for a particular customer application**. As a rule, EPCOS is either unfamiliar with individual customer applications or less familiar with them than the customers themselves. For these reasons, it is always ultimately incumbent on the customer to check and decide whether an EPCOS product with the properties described in the product specification is suitable for use in a particular customer application.
2. We also point out that **in individual cases, a malfunction of electronic components or failure before the end of their usual service life cannot be completely ruled out in the current state of the art, even if they are operated as specified**. In customer applications requiring a very high level of operational safety and especially in customer applications in which the malfunction or failure of an electronic component could endanger human life or health (e.g. in accident prevention or life-saving systems), it must therefore be ensured by means of suitable design of the customer application or other action taken by the customer (e.g. installation of protective circuitry or redundancy) that no injury or damage is sustained by third parties in the event of malfunction or failure of an electronic component.
3. **The warnings, cautions and product-specific notes must be observed.**
4. In order to satisfy certain technical requirements, **some of the products described in this publication may contain substances subject to restrictions in certain jurisdictions (e.g. because they are classed as hazardous)**. Useful information on this will be found in our Material Data Sheets on the Internet ([www.epcos.com/material](http://www.epcos.com/material)). Should you have any more detailed questions, please contact our sales offices.
5. We constantly strive to improve our products. Consequently, **the products described in this publication may change from time to time**. The same is true of the corresponding product specifications. Please check therefore to what extent product descriptions and specifications contained in this publication are still applicable before or when you place an order.

We also **reserve the right to discontinue production and delivery of products**. Consequently, we cannot guarantee that all products named in this publication will always be available. The aforementioned does not apply in the case of individual agreements deviating from the foregoing for customer-specific products.

6. Unless otherwise agreed in individual contracts, **all orders are subject to the current version of the “General Terms of Delivery for Products and Services in the Electrical Industry” published by the German Electrical and Electronics Industry Association (ZVEI)**.
7. The trade names EPCOS, BAOKE, Alu-X, CeraDiode, CeraLink, CSMP, CSSP, CTVS, DeltaCap, DigiSiMic, DSSP, FilterCap, FormFit, MiniBlue, MiniCell, MKD, MKK, MLSC, MotorCap, PCC, PhaseCap, PhaseCube, PhaseMod, PhiCap, SIFERRIT, SIFI, SIKOREL, SilverCap, SIMDAD, SiMic, SIMID, SineFormer, SIOV, SIP5D, SIP5K, ThermoFuse, WindCap are **trademarks registered or pending** in Europe and in other countries. Further information will be found on the Internet at [www.epcos.com/trademarks](http://www.epcos.com/trademarks).