

## 4-line EMC filters

**Series/Type:**      **B84144\***

The following products presented in this data sheet are being withdrawn.

Ordering Code	Substitute Product	Date of Withdrawal	Deadline Last Orders	Last Shipments
B84144G0250S000	B84144B*S120, B84144B*S121	2009-03-13	2009-06-30	2009-09-30
B84144G0500S000	B84144B*S120, B84144B*S121	2009-03-13	2009-06-30	2009-09-30
B84144G1000S000		2009-03-13	2009-06-30	2009-09-30



Ordering Code	Substitute Product	Date of Withdrawal	Deadline Last Orders	Last Shipments
B84144G1600S000		2009-03-13	2009-06-30	2009-09-30

For further information please contact your nearest EPCOS sales office, which will also support you in selecting a suitable substitute. The addresses of our worldwide sales network are presented at [www.epcos.com/sales](http://www.epcos.com/sales).

**Power line filters for 3-phase systems**  
**Rated voltage 440/250 V AC, 50/60 Hz**  
**Rated current 16 to 1600 A**

#### Alternative version

- Series B84144A\*R120 and B84144B\*S120/S121 offer a low-cost solution.

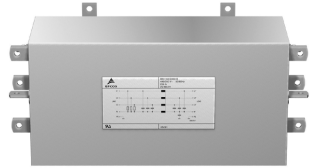

#### Construction

- 4-line filter
- Metal case
- Threaded bushes at end faces for RF-tight installation

#### Features

- Optimized leakage current
- Easy to install
- Degree of protection up to 180 A: IP 20<sup>1)</sup>
- Space-saving design
- Design complies with EN 133200, UL 1283, CSA C22.2 No.8
- UL approval 

#### Applications

- General applications for power electronics
- UPS
- Wind farms
- For machine tools, textile and packaging machines

#### Terminals

- Finger-safe terminal blocks for filters up to 180 A
- Busbars for filters 250 to 1600 A

#### Marking

Marking on component:  
 Manufacturer's logo, ordering code,  
 rated voltage, rated current,  
 climatic category, date code

Minimum marking on packaging:  
 Manufacturer's logo, ordering code

1) To IEC 60529

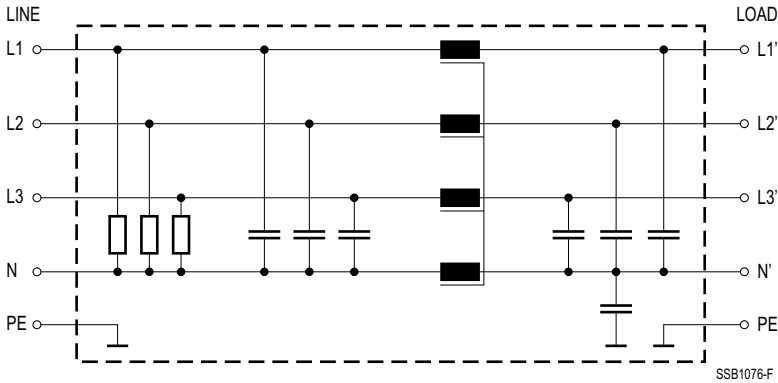
**Typical circuit diagram**

**Technical data and measuring conditions**

Rated voltage $V_R$	440/250 V AC, 50/60 Hz
Rated current $I_R$	Referred to 40 °C ambient temperature
Test voltage $V_{test}$	1770 V DC, 2 s (line/line) 2700 V DC, 2 s (lines/case), for 16 ... 50 A 2550 V DC, 2 s (lines/case), for 80 ... 180 A 2121 V DC, 2 s (lines/case), for 250 ... 1600 A
Overload capability (thermal)	$1.5 \cdot I_R$ for 3 min per hour or $2.5 \cdot I_R$ for 30 s per hour
Leakage current $I_{leak}$	At 400 V AC, 50 Hz
Climatic category (IEC 60068-1)	25/100/21 (-25 °C/+100 °C/21 days damp heat test)
Approvals	UL 1283

**Characteristics and ordering codes**

$V_R$ AC V	$I_R$ A	Terminal cross section mm <sup>2</sup>	$I_{leak}$ mA	$R_{typ}$ mΩ	Approx. weight kg	Ordering code	Approvals 
440/250	16	4	< 3.5	10	2.2	B84144A0016R000	×
	25	10	< 3.5	6	3.7	B84144A0025R000	×
	36	10	< 3.5	3.5	3.7	B84144A0036R000	×
	50	10	< 6	1.3	4.0	B84144A0050R000	×
	80	25	< 6	0.7	9.5	B84144A0080R000	×
	120	50	< 6	0.5	10	B84144A0120R000	×
	150	50	< 6	0.35	10	B84144A0150R000	×
	180	95	< 6	0.25	13	B84144A0180R000	×
	250	Busbars	< 6	0.095	32	B84144G0250S000	×
	500		< 6	0.060	53	B84144G0500S000	–
	1000		< 6	0.030	140	B84144G1000S000	–
	1600		< 6	0.020	185	B84144G1600S000	–

× = approval granted

Not for new design. Substitute B84144B\*S120/S121.

Dimensional drawings

B84144A0016R000 (16 A)

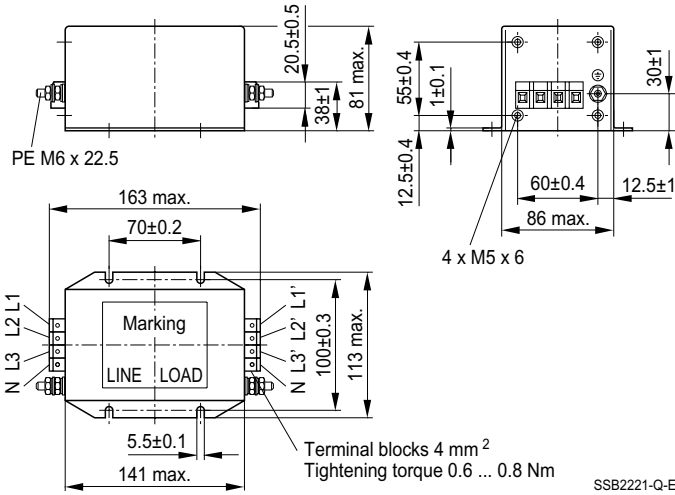

B84144A0025R000, B84144A0036R000, B84144A0050R000 (25 A, 36 A, 50 A)

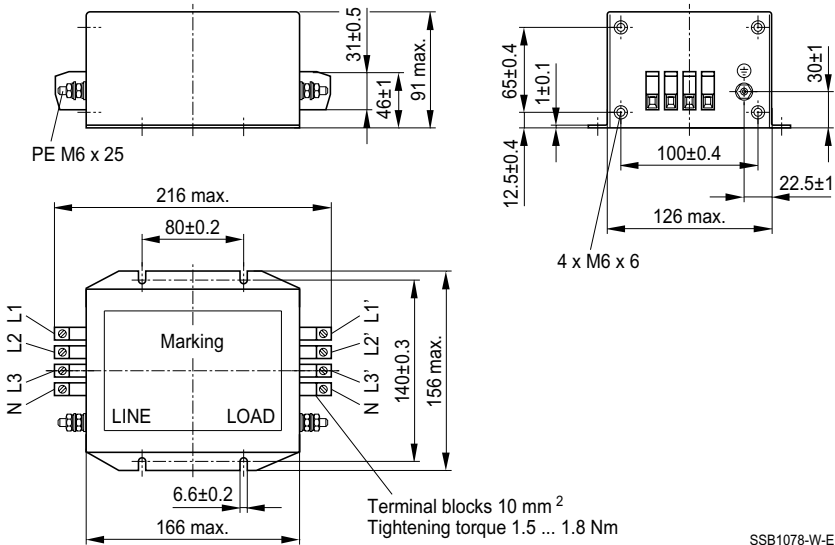

4-line filters

B84144A\*R, B84144G\*S

for converters and power electronics

**B84144A0080R000 (80 A)**

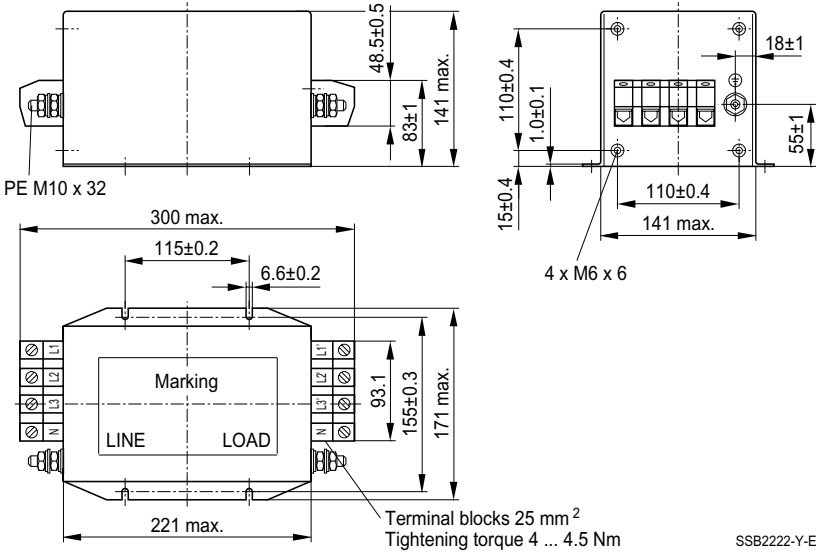

**B84144A0120R000, B84144A0150R000 (120 A, 150 A)**

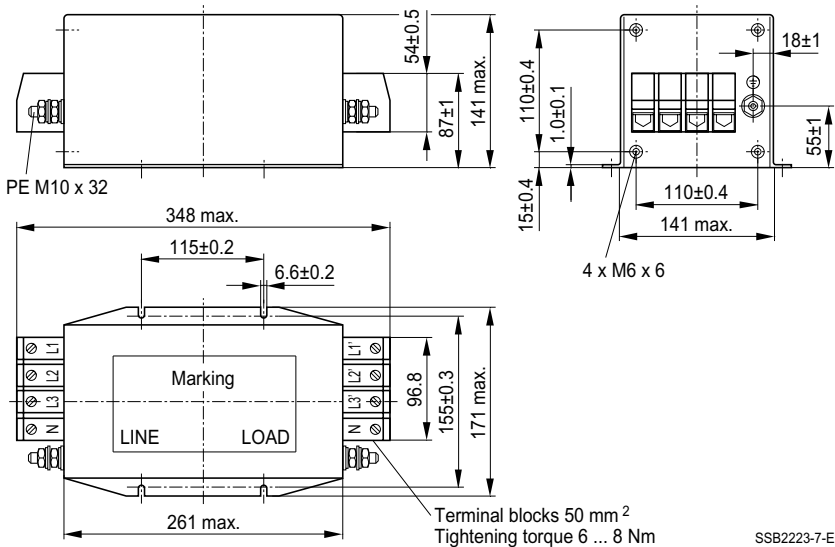

**B84144A0180R000 (180 A)**

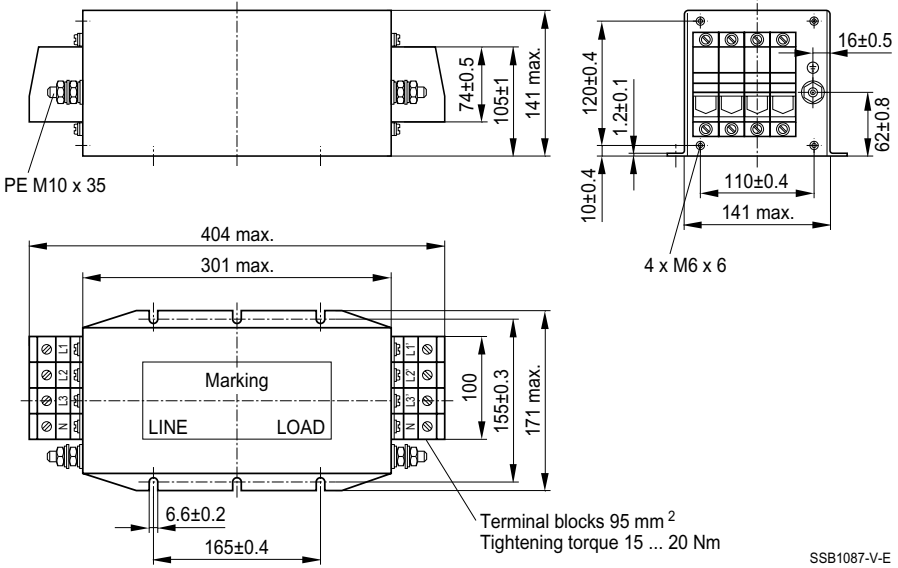

SSB1087-V-E



**B84144G0250S000 (250 A)**

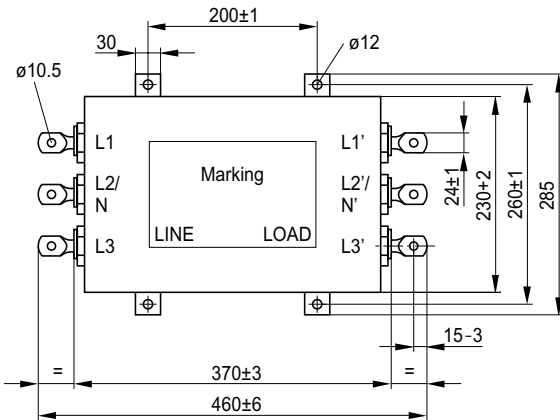
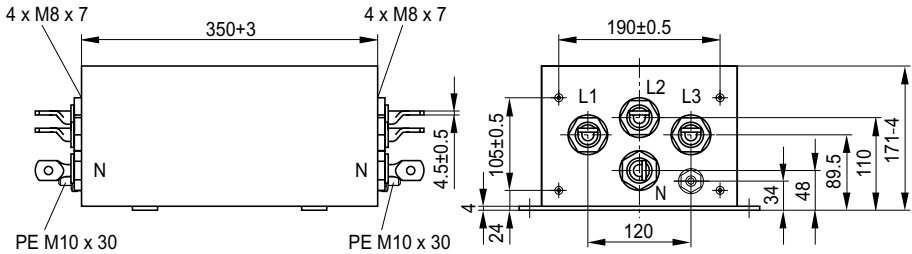

SSB0996-A

**B84144G0500S000 (500 A)**

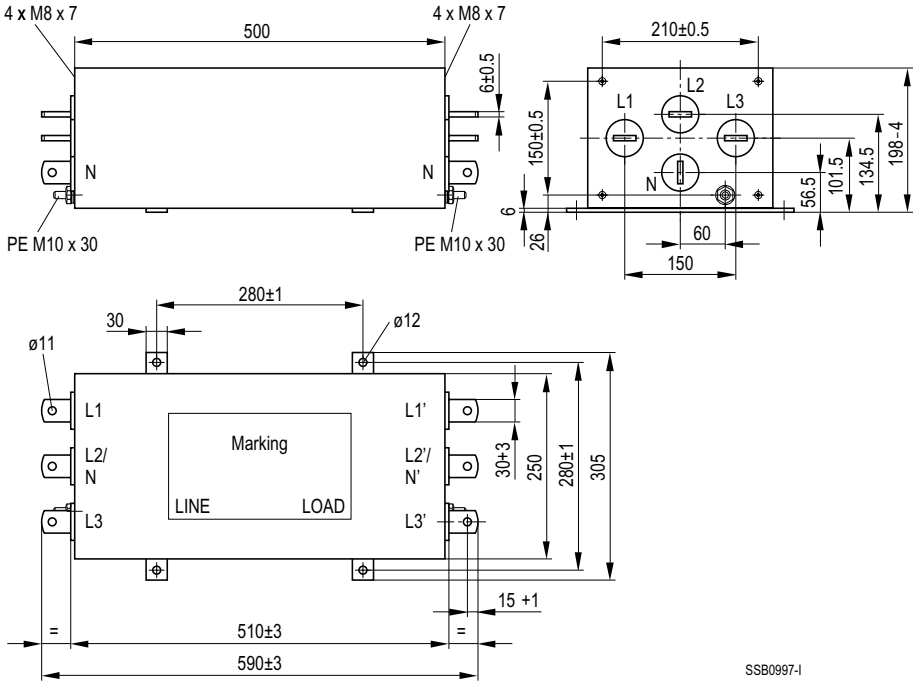

SSB0997-1

**B84144G1000S000 (1000 A)**

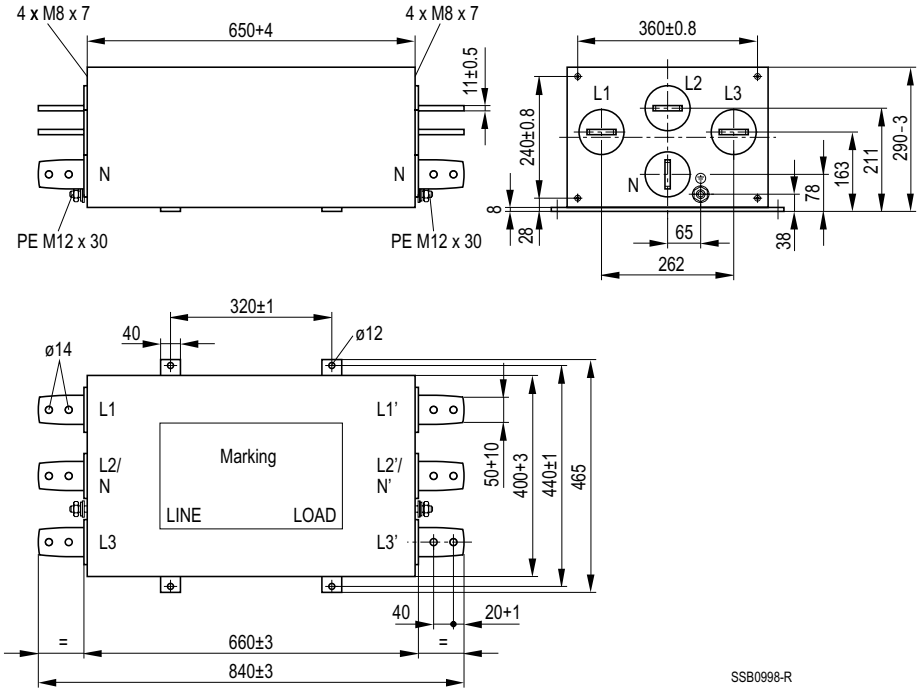

SSB0998-R

B84144G1600S000 (1600 A)

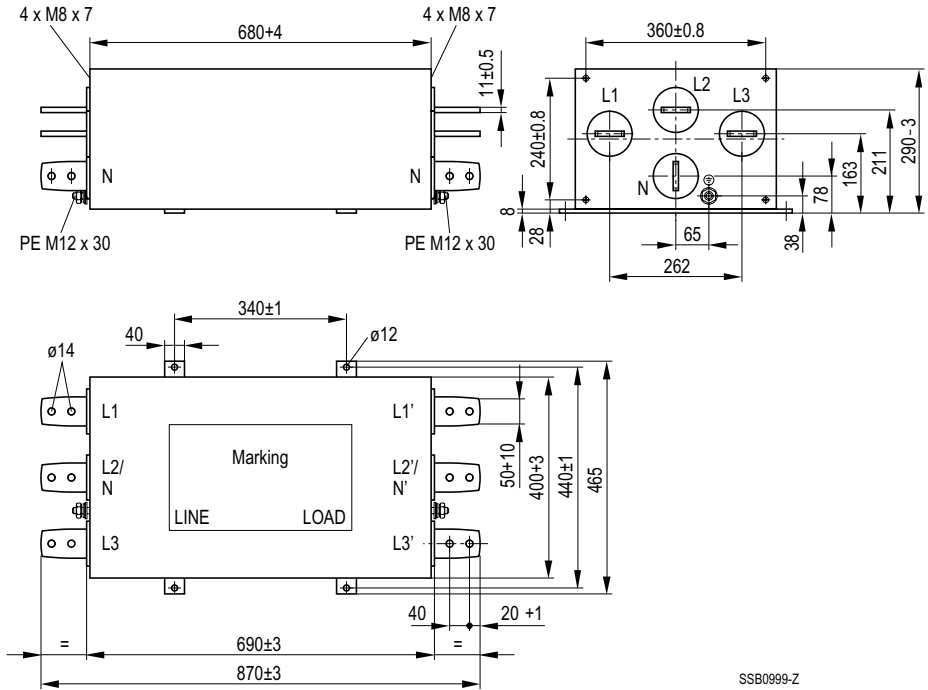

SSB0999-Z

**Insertion loss** (typical values at  $Z = 50 \Omega$ )

- unsymmetrical, adjacent branches terminated
- - - - - common mode, all branches in parallel (asymmetrical)
- - - - - differential mode (symmetrical)

Filters for 16 ... 36 A

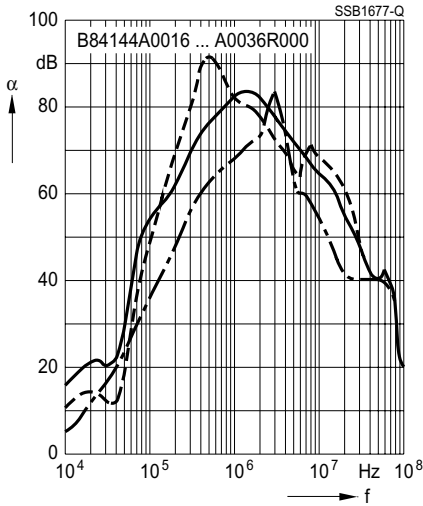

Filters for 50 A

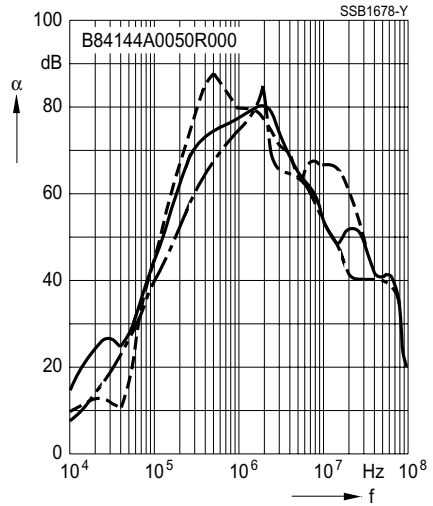

Filters for 80 A

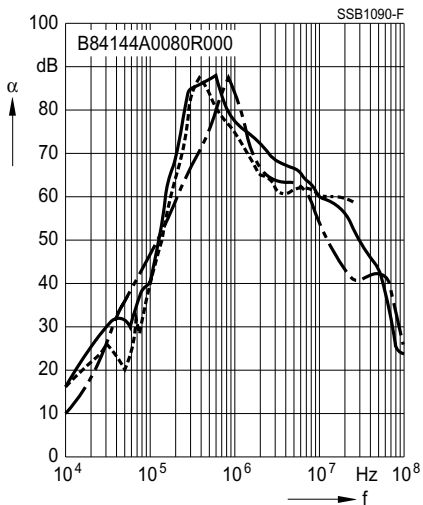

Filters for 120 and 150 A

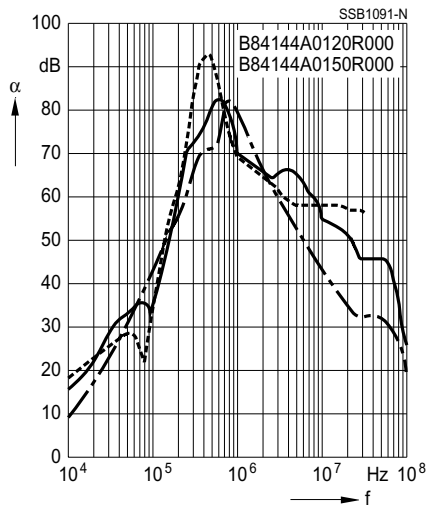

**Insertion loss** (typical values at  $Z = 50 \Omega$ )

- unsymmetrical, adjacent branches terminated
- - - - - common mode, all branches in parallel (asymmetrical)
- - - - - differential mode (symmetrical)

Filters for 180 A

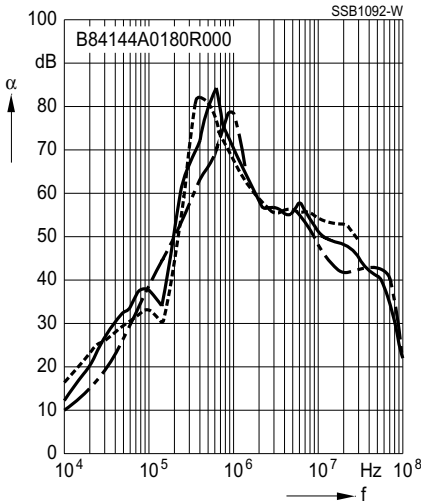

Filters for 250 to 1600 A

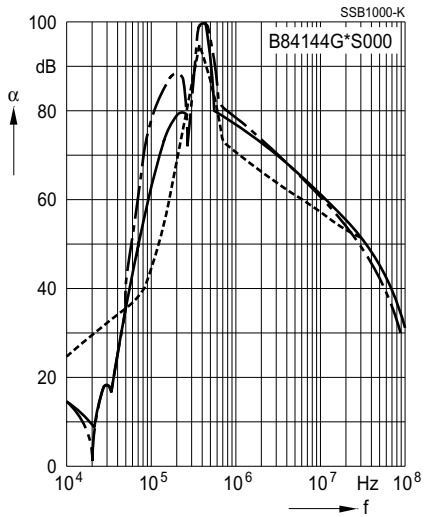

### Important information

Please read all safety and warning notes carefully before installing the EMC filter and putting it into operation (see ) . The same applies to the warning signs on the filter. Please ensure that the signs are not removed nor their legibility impaired by external influences.

Death, serious bodily injury and substantial material damage to equipment may occur if the appropriate safety measures are not carried out or the warnings in the text are not observed.

### Using according to the terms

The EMC filters may be used only for their intended application within the specified values in low-voltage networks in compliance with the instructions given in the data sheets and the data book. The conditions at the place of application must comply with all specifications for the filter used.

### Warnings

- It shall be ensured that only qualified persons (electricity specialists) are engaged on work such as planning, assembly, installation, operation, repair and maintenance. They must be provided with the corresponding documentation.
- Danger of electric shock. EMC filters contain components that store an electric charge. Dangerous voltages can continue to exist at the filter terminals for longer than five minutes even after the power has been switched off.
- The protective earth connections shall be the first to be made when the EMC filter is installed and the last to be disconnected. Depending on the magnitude of the leakage currents, the particular specifications for making the protective-earth connection must be observed.
- Impermissible overloading of the EMC filter, such as impermissible voltages at higher frequencies that may cause resonances etc. can lead to destruction of the filter housing.
- EMC filters must be protected in the application against impermissible exceeding of the rated currents by suitable overcurrent protective.

The following applies to all products named in this publication:

1. Some parts of this publication contain **statements about the suitability of our products for certain areas of application**. These statements are based on our knowledge of typical requirements that are often placed on our products in the areas of application concerned. We nevertheless expressly point out **that such statements can not be regarded as binding statements about the suitability of our products for a particular customer application**. As a rule, EPCOS is either unfamiliar with individual customer applications or less familiar with them than the customers themselves. For these reasons, it is always ultimately incumbent on the customer to check and decide whether an EPCOS product with the properties described in the product specification is suitable for use in a particular customer application.
2. We also point out that **in individual cases, a malfunction of passive electronic components or failure before the end of their usual service life cannot be completely ruled out in the current state of the art, even if they are operated as specified**. In customer applications requiring a very high level of operational safety and especially in customer applications in which the malfunction or failure of a passive electronic component could endanger human life or health (e.g. in accident prevention or life-saving systems), it must therefore be ensured by means of suitable design of the customer application or other action taken by the customer (e.g. installation of protective circuitry or redundancy) that no injury or damage is sustained by third parties in the event of malfunction or failure of a passive electronic component.
3. **The warnings, cautions and product-specific notes must be observed.**
4. In order to satisfy certain technical requirements, **some of the products described in this publication may contain substances subject to restrictions in certain jurisdictions (e.g. because they are classed as “hazardous”)**. Useful information on this will be found in our Material Data Sheets on the Internet ([www.epcos.com/material](http://www.epcos.com/material)). Should you have any more detailed questions, please contact our sales offices.
5. We constantly strive to improve our products. Consequently, **the products described in this publication may change from time to time**. The same is true of the corresponding product specifications. Please check therefore to what extent product descriptions and specifications contained in this publication are still applicable before or when you place an order.  
We also **reserve the right to discontinue production and delivery of products**. Consequently, we cannot guarantee that all products named in this publication will always be available.
6. Unless otherwise agreed in individual contracts, **all orders are subject to the current version of the “General Terms of Delivery for Products and Services in the Electrical Industry” published by the German Electrical and Electronics Industry Association (ZVEI)**.
7. The trade names EPCOS, EPCOS-Jones, Baoke, CeraDiode, CSSP, MLSC, PhaseCap, PhaseMod, SIFI, SIKOREL, SilverCap, SIMID, SIOV, SIP5D, SIP5K, UltraCap, WindCap are **trademarks registered or pending** in Europe and in other countries. Further information will be found on the Internet at [www.epcos.com/trademarks](http://www.epcos.com/trademarks).