

SIOV metal oxide varistors

Block varistors, HighE series

Series/Type: B722*
Date: April 2011

© EPCOS AG 2015. Reproduction, publication and dissemination of this publication, enclosures hereto and the information contained therein without EPCOS' prior express consent is prohibited.

EPCOS AG is a TDK Group Company.

HighE series
Construction

- Disk-shaped varistor element, potted in plastic housing
- Housing and potting flame-retardant to UL 94 V-0
- Screw terminals M4 (SIOV-B32 ... 40)
Screw terminals M5 (SIOV-B60 ... 80)

Features

- Heavy-duty varistors (surge current capability up to 100 kA)
- Wide operating voltage range 75 ... 1100 V_{RMS}
- SIOV-B40 also available without housing (LS40 series)
- PSpice models

Approvals

- UL
- CSA (≥ K130)

Delivery mode

- Cardboard box

General technical data

Climatic category	to IEC 60068-1	40/85/56	
Operating temperature	to CECC 42 000	-40 ... + 85	°C
Storage temperature		-40 ... +110	°C
Electric strength	to CECC 42 000	≥ 2.5	kV _{RMS}
Insulation resistance	to CECC 42 000	≥ 10	MΩ
Response time		< 25	ns
Maximum torque for B32 and B40 types		1.0	Nm
Maximum torque for B60 and B80 types		2.5	Nm

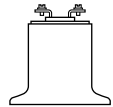
Electrical specifications and ordering codes
Maximum ratings ($T_A = 85\text{ }^\circ\text{C}$)

Ordering code	Type	V_{RMS}	V_{DC}	i_{max} (8/20 μs)	W_{max} (2 ms)	P_{max}
	SIOV-	V	V	A	J	W
$V_{\text{RMS}} = 75\text{ V}$						
B72240B0750K001	B40K75	75	100	25000	190	1.4
$V_{\text{RMS}} = 130\text{ V}$						
B72232B0131K001	B32K130	130	170	25000	210	1.2
B72240B0131K001	B40K130	130	170	40000	310	1.4
B72260B0131K001	B60K130	130	170	70000	490	1.6
B72280B0131K001	B80K130	130	170	100000	660	2.0
$V_{\text{RMS}} = 150\text{ V}$						
B72232B0151K001	B32K150	150	200	25000	240	1.2
B72240B0151K001	B40K150	150	200	40000	360	1.4
B72260B0151K001	B60K150	150	200	70000	570	1.6
B72280B0151K001	B80K150	150	200	100000	800	2.0
$V_{\text{RMS}} = 230\text{ V}$						
B72232B0231K001	B32K230	230	300	25000	300	1.2
B72240B0231K001	B40K230	230	300	40000	460	1.4
B72260B0231K001	B60K230	230	300	70000	730	1.6
B72280B0231K001	B80K230	230	300	100000	1200	2.0
$V_{\text{RMS}} = 250\text{ V}$						
B72232B0251K001	B32K250	250	320	25000	330	1.2
B72240B0251K001	B40K250	250	320	40000	490	1.4
B72260B0251K001	B60K250	250	320	70000	800	1.6
B72280B0251K001	B80K250	250	320	100000	1300	2.0
$V_{\text{RMS}} = 275\text{ V}$						
B72232B0271K001	B32K275	275	350	25000	360	1.2
B72240B0271K001	B40K275	275	350	40000	550	1.4
B72260B0271K001	B60K275	275	350	70000	860	1.6
B72280B0271K001	B80K275	275	350	100000	1400	2.0
$V_{\text{RMS}} = 320\text{ V}$						
B72232B0321K001	B32K320	320	420	25000	430	1.2
B72240B0321K001	B40K320	320	420	40000	640	1.4
B72260B0321K001	B60K320	320	420	70000	1000	1.6
B72280B0321K001	B80K320	320	420	100000	1600	2.0

Varistor elements without plastic housing (suitable for soldering) are available upon request.

Block varistors
B722*
HighE series
Characteristics (T_A = 25 °C)

Ordering code	V _v (1 mA) V	ΔV _v (1 mA) %	V _{C,max} (i _c) V	i _c A	C _{typ} (1 kHz) pF
V_{RMS} = 75 V					
B72240B0750K001	120	±10	220	300	11000
V_{RMS} = 130 V					
B72232B0131K001	205	±10	340	200	4400
B72240B0131K001	205	±10	340	300	5600
B72260B0131K001	205	±10	340	500	15000
B72280B0131K001	205	±10	340	800	28000
V_{RMS} = 150 V					
B72232B0151K001	240	±10	395	200	3700
B72240B0151K001	240	±10	395	300	4800
B72260B0151K001	240	±10	395	500	12000
B72280B0151K001	240	±10	395	800	23000
V_{RMS} = 230 V					
B72232B0231K001	360	±10	595	200	2500
B72240B0231K001	360	±10	595	300	3200
B72260B0231K001	360	±10	595	500	7900
B72280B0231K001	360	±10	595	800	16000
V_{RMS} = 250 V					
B72232B0251K001	390	±10	650	200	2200
B72240B0251K001	390	±10	650	300	2900
B72260B0251K001	390	±10	650	500	7100
B72280B0251K001	390	±10	650	800	14000
V_{RMS} = 275 V					
B72232B0271K001	430	±10	710	200	2000
B72240B0271K001	430	±10	710	300	2700
B72260B0271K001	430	±10	710	500	6600
B72280B0271K001	430	±10	710	800	13000
V_{RMS} = 320 V					
B72232B0321K001	510	±10	840	200	1700
B72240B0321K001	510	±10	840	300	2300
B72260B0321K001	510	±10	840	500	5600
B72280B0321K001	510	±10	840	800	11000

Varistor elements without plastic housing (suitable for soldering) are available upon request.

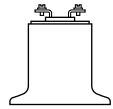
Electrical specifications and ordering codes
Maximum ratings ($T_A = 85\text{ }^\circ\text{C}$)

Ordering code	Type	V_{RMS}	V_{DC}	i_{max} (8/20 μs)	W_{max} (2 ms)	P_{max}
	SIOV-	V	V	A	J	W
$V_{RMS} = 385\text{ V}$						
B72232B0381K001	B32K385	385	505	25000	550	1.2
B72240B0381K001	B40K385	385	505	40000	800	1.4
B72260B0381K001	B60K385	385	505	70000	1200	1.6
B72280B0381K001	B80K385	385	505	100000	2000	2.0
$V_{RMS} = 420\text{ V}$						
B72232B0421K001	B32K420	420	560	25000	600	1.2
B72240B0421K001	B40K420	420	560	40000	910	1.4
B72260B0421K001	B60K420	420	560	70000	1500	1.6
B72280B0421K001	B80K420	420	560	100000	2200	2.0
$V_{RMS} = 440\text{ V}$						
B72232B0441K001	B32K440	440	585	25000	630	1.2
B72240B0441K001	B40K440	440	585	40000	950	1.4
B72260B0441K001	B60K440	440	585	70000	1580	1.6
B72280B0441K001	B80K440	440	585	100000	2350	2.0
$V_{RMS} = 460\text{ V}$						
B72232B0461K001	B32K460	460	615	25000	660	1.2
B72240B0461K001	B40K460	460	615	40000	1000	1.4
B72260B0461K001	B60K460	460	615	70000	1650	1.6
B72280B0461K001	B80K460	460	615	100000	2500	2.0
$V_{RMS} = 550\text{ V}$						
B72232B0551K001	B32K550	550	745	25000	620	1.2
B72240B0551K001	B40K550	550	745	40000	960	1.4
B72260B0551K001	B60K550	550	745	70000	1500	1.6
B72280B0551K001	B80K550	550	745	100000	3100	2.0
$V_{RMS} = 680\text{ V}$						
B72232B0681K001	B32K680	680	895	25000	760	1.2
B72240B0681K001	B40K680	680	895	40000	1100	1.4
B72260B0681K001	B60K680	680	895	70000	1800	1.6
B72280B0681K001	B80K680	680	895	100000	3600	2.0

Varistor elements without plastic housing (suitable for soldering) are available upon request.

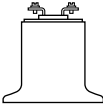
Block varistors
B722*
HighE series
Characteristics (T_A = 25 °C)

Ordering code	V _v (1 mA) V	ΔV _v (1 mA) %	V _{C,max} (i _c) V	i _c A	C _{typ} (1 kHz) pF
V_{RMS} = 385 V					
B72232B0381K001	620	±10	1025	200	1400
B72240B0381K001	620	±10	1025	300	1900
B72260B0381K001	620	±10	1025	500	4600
B72280B0381K001	620	±10	1025	800	9000
V_{RMS} = 420 V					
B72232B0421K001	680	±10	1120	200	1300
B72240B0421K001	680	±10	1120	300	1800
B72260B0421K001	680	±10	1120	500	4300
B72280B0421K001	680	±10	1120	800	8500
V_{RMS} = 440 V					
B72232B0441K001	715	±10	1180	200	1250
B72240B0441K001	715	±10	1180	300	1700
B72260B0441K001	715	±10	1180	500	4100
B72280B0441K001	715	±10	1180	800	8100
V_{RMS} = 460 V					
B72232B0461K001	750	±10	1240	200	1200
B72240B0461K001	750	±10	1240	300	1600
B72260B0461K001	750	±10	1240	500	3900
B72280B0461K001	750	±10	1240	800	7700
V_{RMS} = 550 V					
B72232B0551K001	910	±10	1500	200	1000
B72240B0551K001	910	±10	1500	300	1400
B72260B0551K001	910	±10	1500	500	3300
B72280B0551K001	910	±10	1500	800	6500
V_{RMS} = 680 V					
B72232B0681K001	1100	±10	1815	200	830
B72240B0681K001	1100	±10	1815	300	1100
B72260B0681K001	1100	±10	1815	500	2600
B72280B0681K001	1100	±10	1815	800	5200

Varistor elements without plastic housing (suitable for soldering) are available upon request.

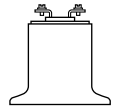
Electrical specifications and ordering codes
Maximum ratings ($T_A = 85\text{ °C}$)

Ordering code	Type	V_{RMS}	V_{DC}	i_{max} (8/20 μ s)	W_{max} (2 ms)	P_{max}
	SIOV-	V	V	A	J	W
$V_{RMS} = 750\text{ V}$						
B72232B0751K001	B32K750	750	970	25000	800	1.2
B72240B0751K001	B40K750	750	970	40000	1200	1.4
B72260B0751K001	B60K750	750	970	70000	2000	1.6
B72280B0751K001	B80K750	750	970	100000	4000	2.0
$V_{RMS} = 1100\text{ V}$						
B72260B0102K001	B60K1000 ¹⁾	1100	1465	70000	3000	1.6
B72280B0112K001	B80K1100	1100	1465	100000	6000	2.0

Varistor elements without plastic housing (suitable for soldering) are available upon request.

Characteristics ($T_A = 25\text{ °C}$)

Ordering code	V_v (1 mA)	ΔV_v (1 mA)	$V_{c,max}$ (i_c)	i_c	C_{typ} (1 kHz)
	V	%	V	A	pF
$V_{RMS} = 750\text{ V}$					
B72232B0751K001	1200	± 10	2000	200	800
B72240B0751K001	1200	± 10	2000	300	1000
B72260B0751K001	1200	± 10	2000	500	2400
B72280B0751K001	1200	± 10	2000	800	4800
$V_{RMS} = 1100\text{ V}$					
B72260B0102K001	1800	± 10	2970	500	1600
B72280B0112K001	1800	± 10	2970	800	3200

Varistor elements without plastic housing (suitable for soldering) are available upon request.

1) Operating voltage differs from type designation

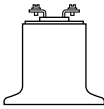

Block varistors

B722*

HighE series

Dimensional drawings

SI0V-B32/-B40

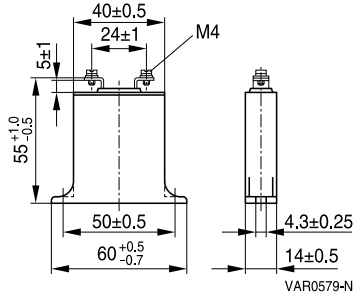

Weight

Nominal diameter mm	V _{RMS} V	Weight g
32	130 ... 750	45
40	75 ... 750	50
60	130 ... 1100	250
80	130 ... 1100	650

SI0V-B60

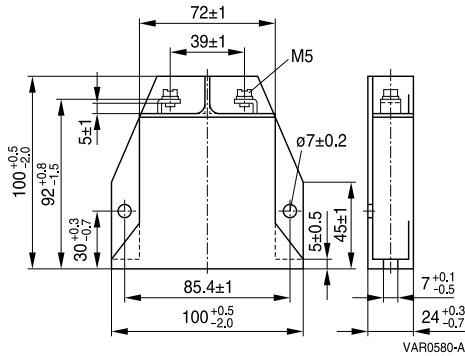

SI0V-B80

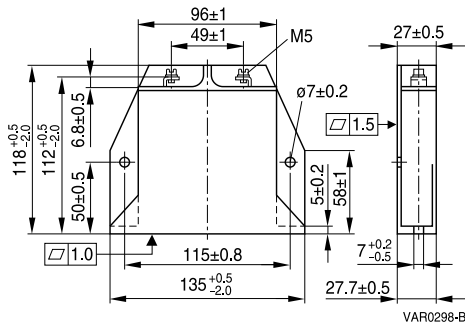

Dimensions in mm

Reliability data

Test	Test methods/conditions	Requirement
Varistor voltage	The voltage between two terminals with the specified measuring current applied is called V_V (1 mA _{DC} @ 0.2 ... 2 s).	To meet the specified value
Clamping voltage	The maximum voltage between two terminals with the specified standard impulse current (8/20 μ s) applied.	To meet the specified value
Max. DC operating voltage	The maximum allowable DC operating voltage V_{DC} at UCT +5/-0 °C is applied for 1000 \pm 48 h. The leakage current I_{leak} (t) during test is recorded. Then the specimen shall be stored at room temperature and normal humidity for 1 to 2 h. Thereafter, the change of V_V shall be measured.	I_{leak} (t = 1000 h) \leq I_{leak} (t = 0 h) $ \Delta V/V$ (1 mA) \leq 10%
Surge current derating, 8/20 μ s	10 surge currents (8/20 μ s), unipolar, interval \geq 60 s, amplitude corresponding to derating curve for 10 impulses at 20 μ s	$ \Delta V/V$ (1 mA) \leq 10% (measured in direction of surge current) No visible damage
Fast temperature cycling	IEC 60068-2-14, test Na, LCT/UCT, dwell time 120 min, 5 cycles	$ \Delta V/V$ (1 mA) \leq 10% No visible damage
Damp heat, steady state	IEC 60068-2-78 The specimen shall be subjected to 40 \pm 2 °C, 90 to 95% r. H. for 56 \pm 2 days with 10% of the maximum continuous DC operating voltage V_{DC} . Then stored at room temperature and normal humidity for 1 to 2 h. Thereafter, the change of V_V shall be measured.	$ \Delta V/V$ (1 mA) \leq 10%

Note:

UCT = Upper category temperature

LCT = Lower category temperature



v/i characteristics

$v = f(i)$ for explanation of the characteristics refer to "General technical information", chapter 1.6.3
 A = Leakage current, B = Protection level } for worst-case varistor tolerances

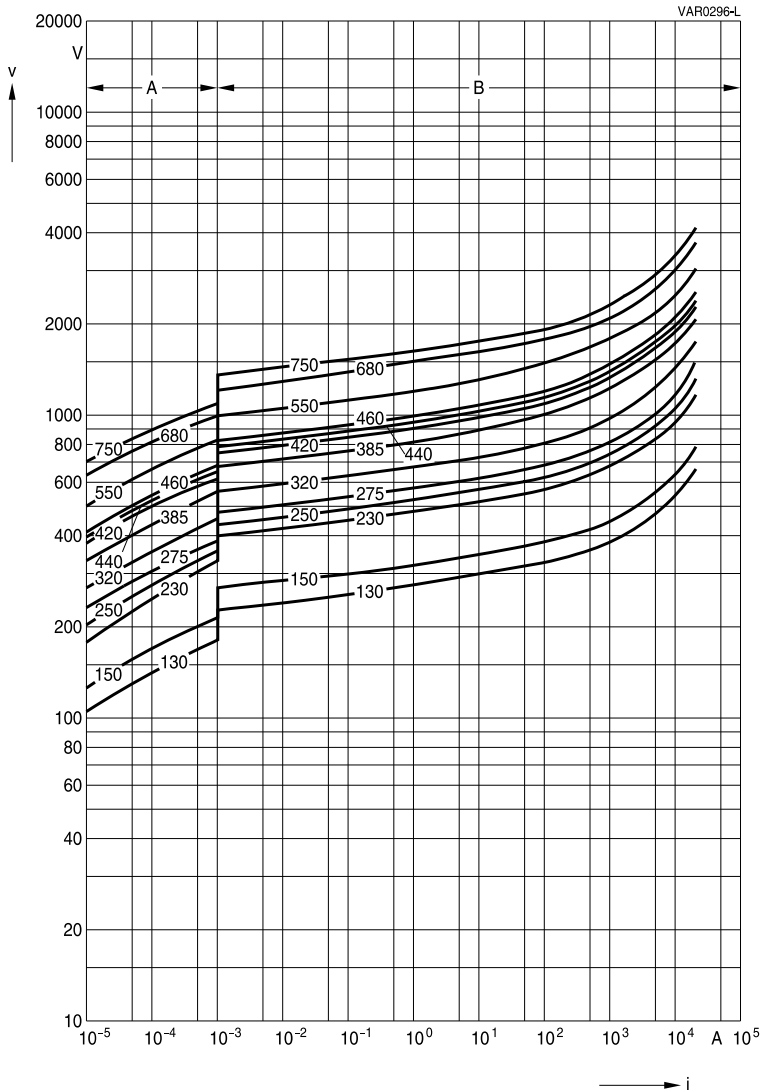

SIOV-B32K130 ... K750

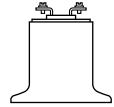

v/i characteristics

$v = f(i)$ for explanation of the characteristics refer to "General technical information", chapter 1.6.3
 A = Leakage current, B = Protection level } for worst-case varistor tolerances

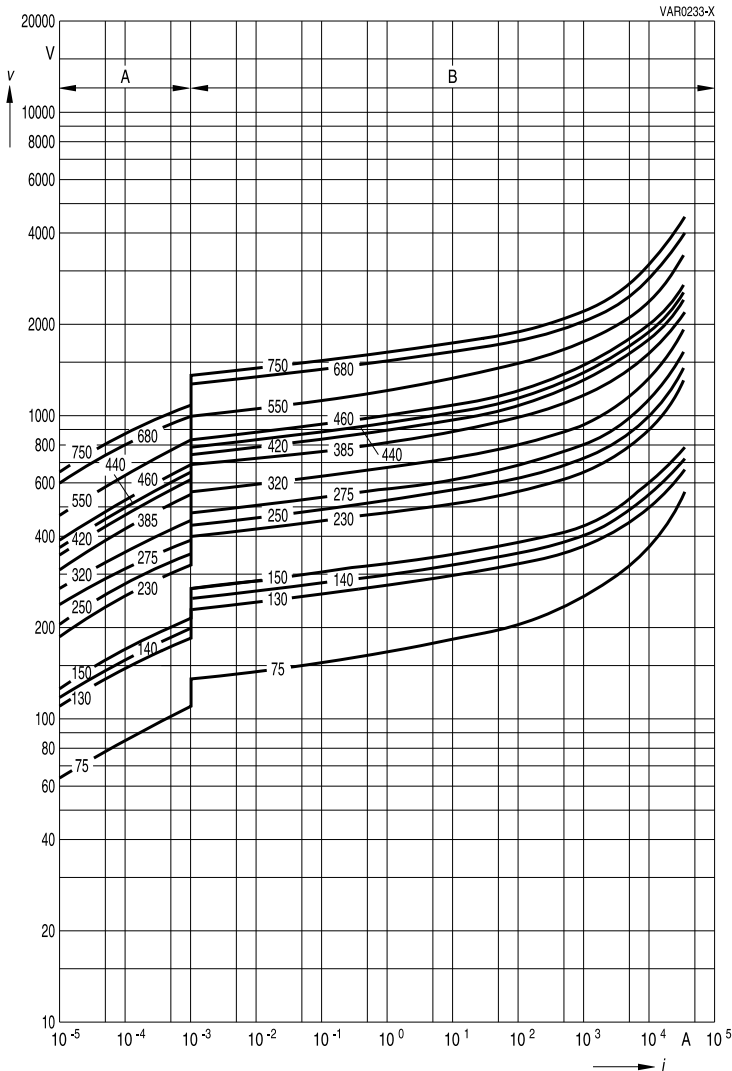

SIOV-B40K75 ... K750



v/i characteristics

$v = f(i)$ for explanation of the characteristics refer to "General technical information", chapter 1.6.3
 A = Leakage current, B = Protection level } for worst-case varistor tolerances

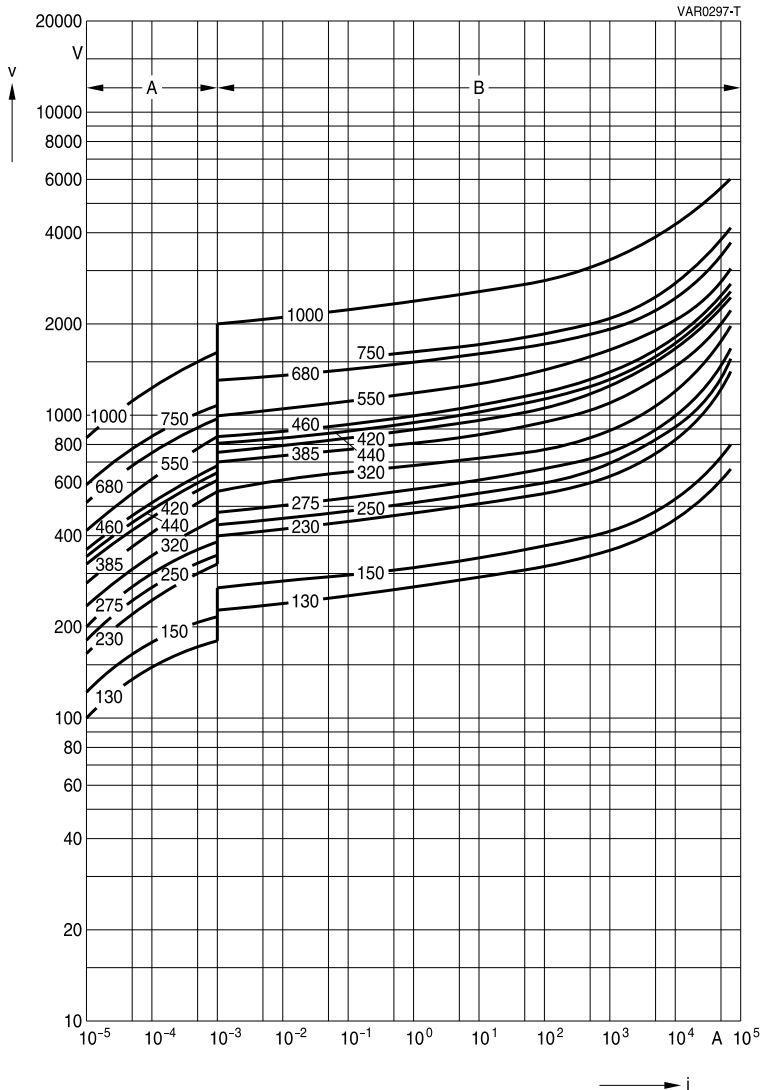

SIOV-B60K130 ... K1000

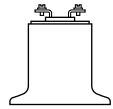

v/i characteristics

$v = f(i)$ for explanation of the characteristics refer to "General technical information", chapter 1.6.3
 A = Leakage current, B = Protection level } for worst-case varistor tolerances

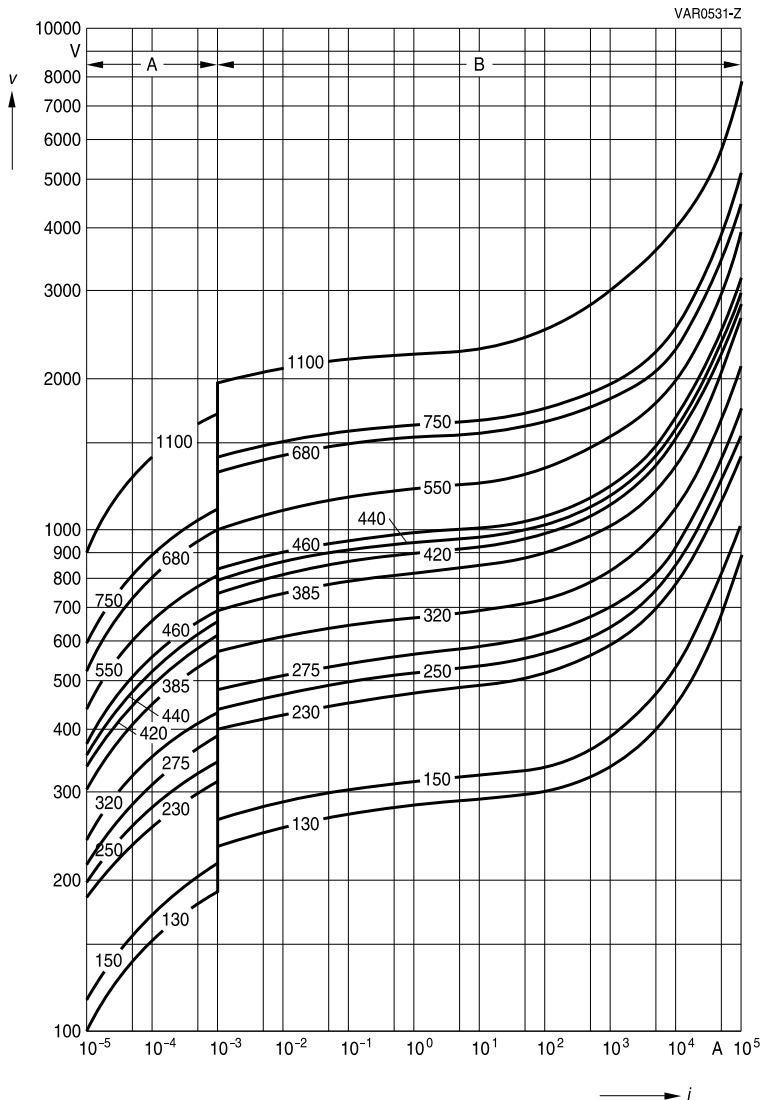

SIOV-B80K130 ... K1100



Derating curves

Maximum surge current $i_{max} = f(t_r, \text{pulse train})$

For explanation of the derating curves refer to "General technical information", section 1.8.1

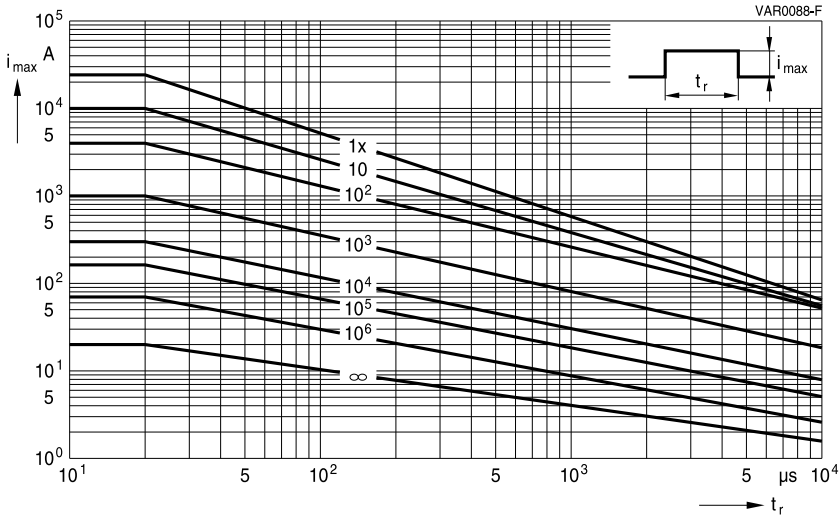

SIOV-B32K130 ... K150

SIOV-B40K75

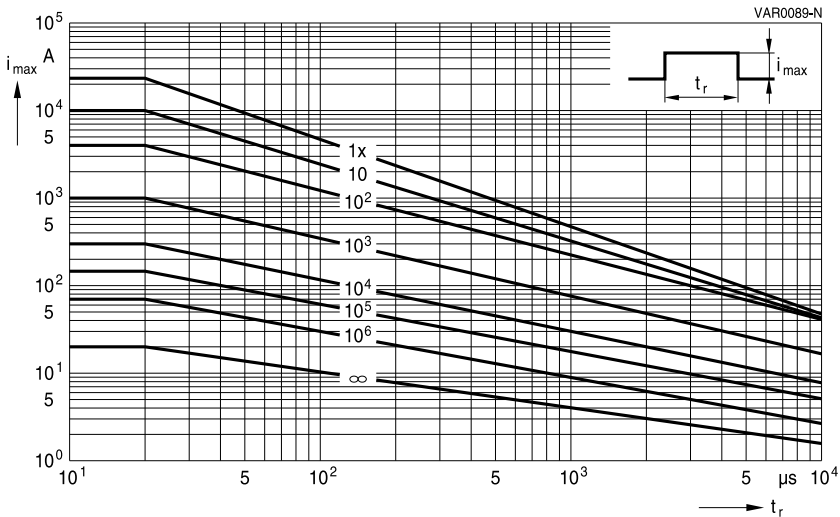

SIOV-B32K230 ... K460



Derating curves

Maximum surge current $i_{max} = f(t_r, \text{pulse train})$

For explanation of the derating curves refer to "General technical information", section 1.8.1

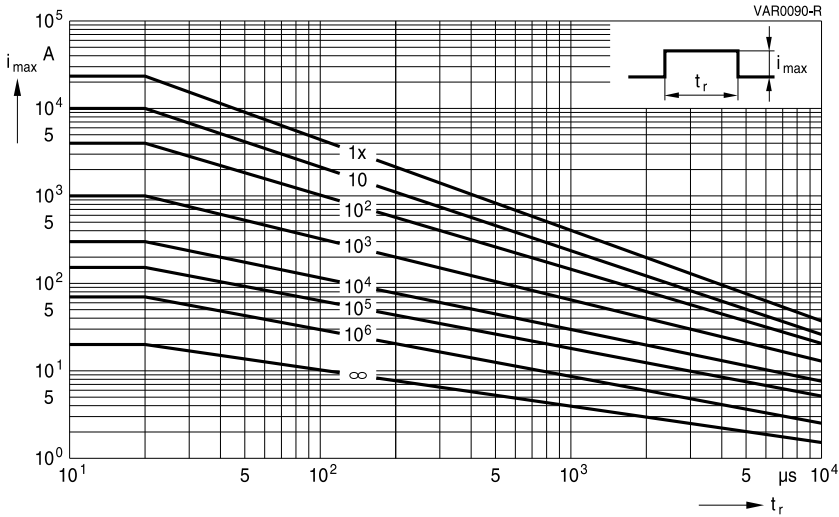

SIOV-B32K550 ... K750

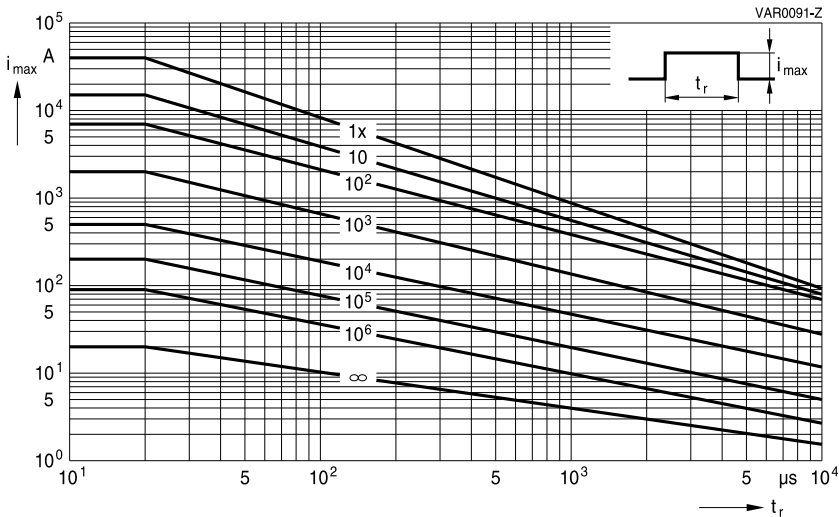

SIOV-B40K130 ... K150

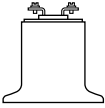

Derating curves

Maximum surge current $i_{max} = f(t_r, \text{pulse train})$

For explanation of the derating curves refer to "General technical information", section 1.8.1

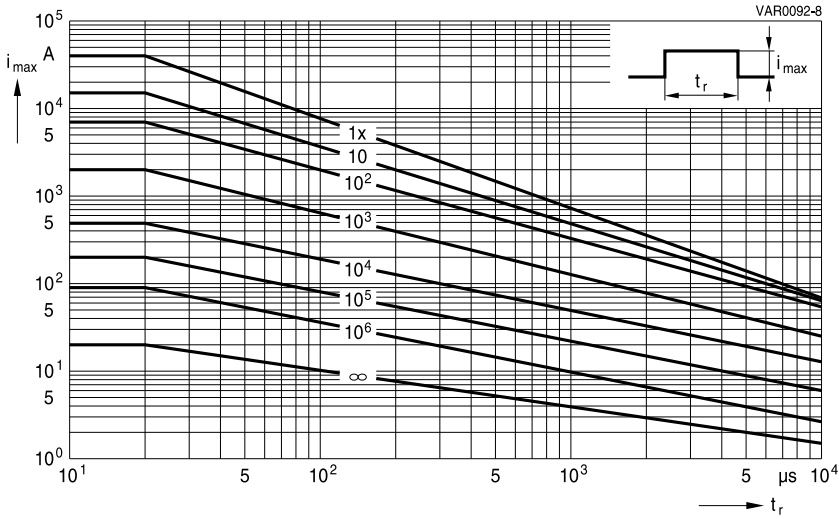

SIOV-B40K230 ... K460

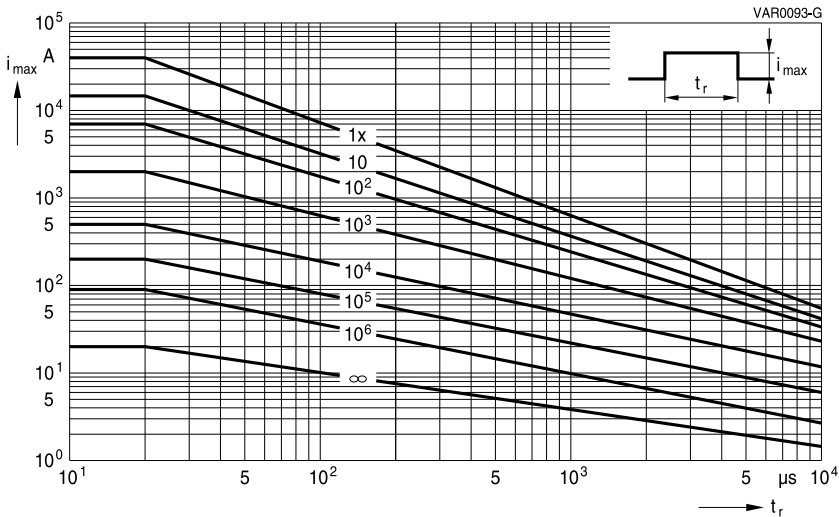

SIOV-B40K550 ... K750



Derating curves

Maximum surge current $i_{max} = f(t_r, \text{pulse train})$

For explanation of the derating curves refer to "General technical information", section 1.8.1

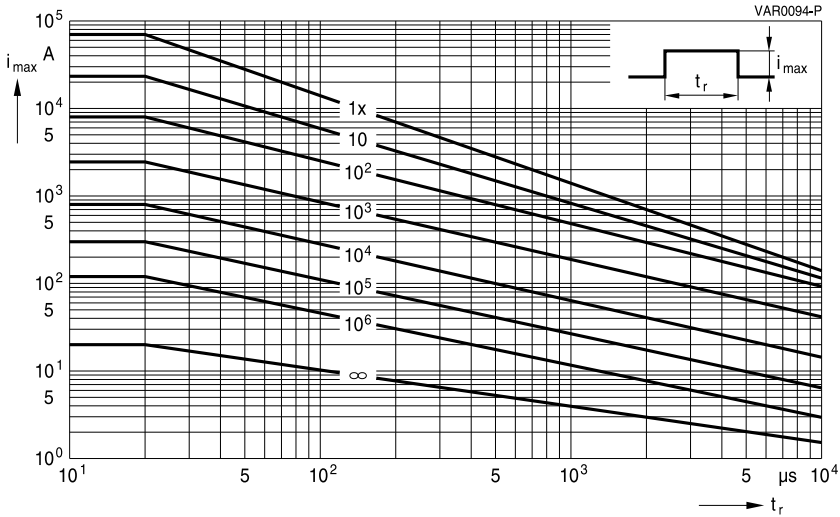

SIOV-B60K130 ... K150

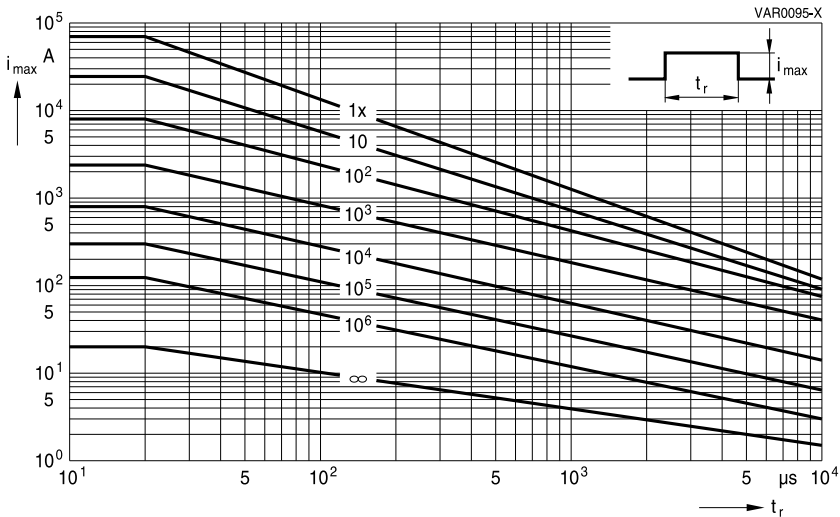

SIOV-B60K230 ... K460

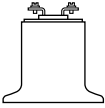

Derating curves

Maximum surge current $i_{max} = f(t_r, \text{pulse train})$

For explanation of the derating curves refer to "General technical information", section 1.8.1

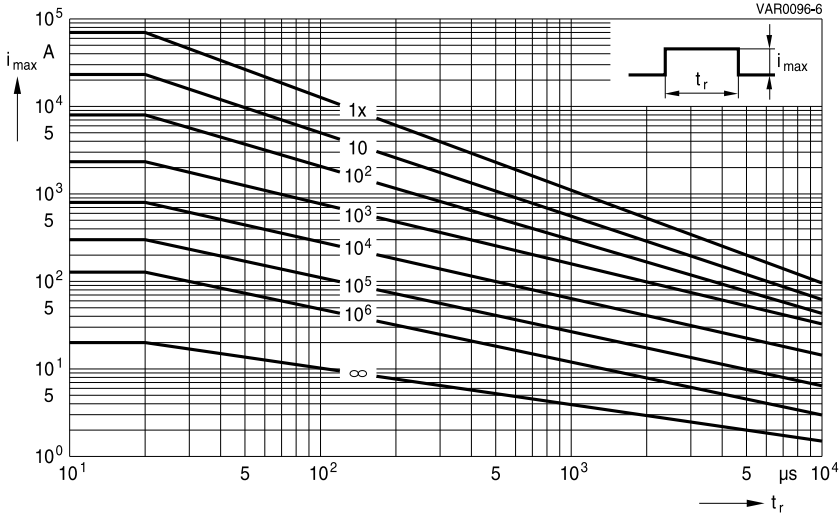

SIOV-B60K550 ... K1000

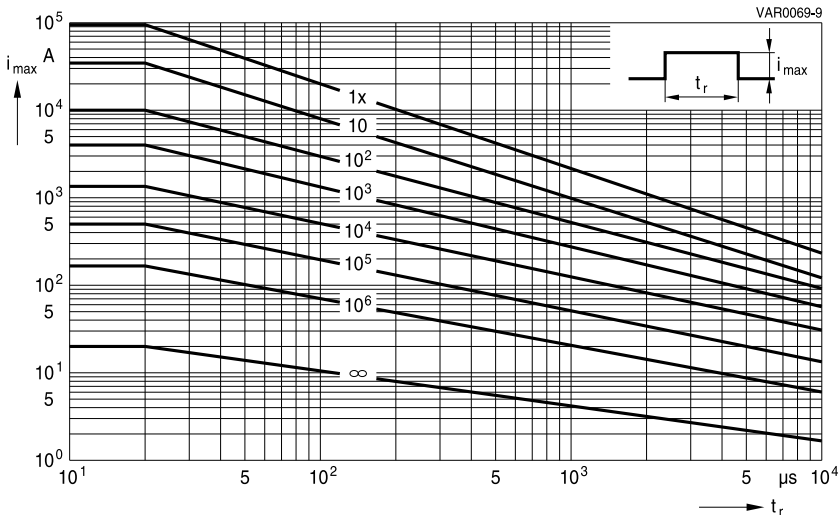

SIOV-B80K130 ... K1100



Mounting

1. Potting, sealing or adhesive compounds can produce chemical reactions in the SIOV ceramic that will degrade the component's electrical characteristics.
2. Overloading SIOVs may result in ruptured packages and expulsion of hot materials. For this reason SIOVs should be physically shielded from adjacent components.

Operation

1. Use SIOVs only within the specified temperature operating range.
2. Use SIOVs only within the specified voltage and current ranges.
3. Environmental conditions must not harm SIOVs. Use SIOVs only in normal atmospheric conditions. Avoid use in deoxidizing gases (chlorine gas, hydrogen sulfide gas, ammonia gas, sulfuric acid gas etc), corrosive agents, humid or salty conditions. Contact with any liquids and solvents should be prevented.

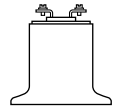
Symbols and terms

Symbol	Term
C	Capacitance
C_{typ}	Typical capacitance
i	Current
i_c	Current at which $V_{c, max}$ is measured
I_{leak}	Leakage current
i_{max}	Maximum surge current (also termed peak current)
I_{max}	Maximum discharge current to IEC 61643-1
I_{nom}	Nominal discharge current to IEC 61643-1
LCT	Lower category temperature
L_{typ}	Typical inductance
P_{max}	Maximum average power dissipation
R_{ins}	Insulation resistance
R_{min}	Minimum resistance
T_A	Ambient temperature
t_r	Duration of equivalent rectangular wave
UCT	Upper category temperature
v	Voltage
V_{clamp}	Clamping voltage
$V_{c, max}$	Maximum clamping voltage at specified current i_c
V_{DC}	DC operating voltage
V_{jump}	Maximum jump start voltage
V_{max}	Maximum voltage
V_{op}	Operating voltage
V_{RMS}	AC operating voltage, root-mean-square value
$V_{RMS, op, max}$	Root-mean-square value of max. DC operating voltage incl. ripple current
V_{surge}	Super imposed surge voltage
V_V	Varistor voltage
ΔV_V	Tolerance of varistor voltage
W_{LD}	Maximum load dump
W_{max}	Maximum energy absorption
e	Lead spacing

All dimensions are given in mm.

The commas used in numerical values denote decimal points.

Important notes

The following applies to all products named in this publication:

1. Some parts of this publication contain **statements about the suitability of our products for certain areas of application**. These statements are based on our knowledge of typical requirements that are often placed on our products in the areas of application concerned. We nevertheless expressly point out **that such statements cannot be regarded as binding statements about the suitability of our products for a particular customer application**. As a rule, EPCOS is either unfamiliar with individual customer applications or less familiar with them than the customers themselves. For these reasons, it is always ultimately incumbent on the customer to check and decide whether an EPCOS product with the properties described in the product specification is suitable for use in a particular customer application.
2. We also point out that **in individual cases, a malfunction of electronic components or failure before the end of their usual service life cannot be completely ruled out in the current state of the art, even if they are operated as specified**. In customer applications requiring a very high level of operational safety and especially in customer applications in which the malfunction or failure of an electronic component could endanger human life or health (e.g. in accident prevention or lifesaving systems), it must therefore be ensured by means of suitable design of the customer application or other action taken by the customer (e.g. installation of protective circuitry or redundancy) that no injury or damage is sustained by third parties in the event of malfunction or failure of an electronic component.
3. **The warnings, cautions and product-specific notes must be observed.**
4. In order to satisfy certain technical requirements, **some of the products described in this publication may contain substances subject to restrictions in certain jurisdictions (e.g. because they are classed as hazardous)**. Useful information on this will be found in our Material Data Sheets on the Internet (www.epcos.com/material). Should you have any more detailed questions, please contact our sales offices.
5. We constantly strive to improve our products. Consequently, **the products described in this publication may change from time to time**. The same is true of the corresponding product specifications. Please check therefore to what extent product descriptions and specifications contained in this publication are still applicable before or when you place an order. We also **reserve the right to discontinue production and delivery of products**. Consequently, we cannot guarantee that all products named in this publication will always be available. The aforementioned does not apply in the case of individual agreements deviating from the foregoing for customer-specific products.
6. Unless otherwise agreed in individual contracts, **all orders are subject to the current version of the "General Terms of Delivery for Products and Services in the Electrical Industry" published by the German Electrical and Electronics Industry Association (ZVEI)**.
7. The trade names EPCOS, BAOKE, Alu-X, CeraDiode, CSMP, CSSP, CTVS, DeltaCap, DigiSiMic, DSSP, FormFit, MiniBlue, MiniCell, MKK, MKD, MLSC, MotorCap, PCC, PhaseCap, PhaseCube, PhaseMod, PhiCap, SIFERRIT, SIFI, SIKOREL, SilverCap, SIMDAD, SiMic, SIMID, SineFormer, SIOV, SIP5D, SIP5K, ThermoFuse, WindCap are **trade-marks registered or pending** in Europe and in other countries. Further information will be found on the Internet at www.epcos.com/trademarks.