



Inductors

RF chokes, HLBC series

Series/Type: B82145A

Date: June 2012

© EPCOS AG 2015. Reproduction, publication and dissemination of this publication, enclosures hereto and the information contained therein without EPCOS' prior express consent is prohibited.

EPCOS AG is a TDK Group Company.

HLBC choke (High-Current Large Bobbin Core)
Rated inductance 100 ... 10 000 μ H
Rated current 110 ... 860 mA
Construction

- Large ferrite drum core
- Winding: enamel copper wire
- Flame-retardant lacquer coating

Features

- High rated current at high inductance ratings
- Radially bent leads in bulk on request (B82145C)
- Suitable for wave soldering
- RoHS-compatible

Applications

- Decoupling
- Interference suppression
- For energy-saving lamps and entertainment electronics

Terminals

- Central axial leads (B82145A)
- Radially bent to 5mm lead spacing (B82145C)
- Base material CuAg0.1
- Electroplated with nickel and pure tin

Marking

Inductance indicated by color bands to IEC 60062

Delivery mode and packing unit

- Taped and reeled
Packing unit: 1250 pcs./reel
- Bulk packaging for radially bent
Packing unit: 200 pcs./polyethylene bag

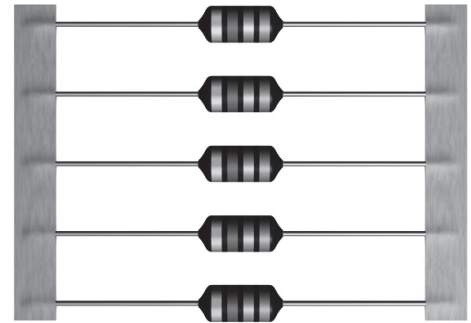

Dimensional drawing

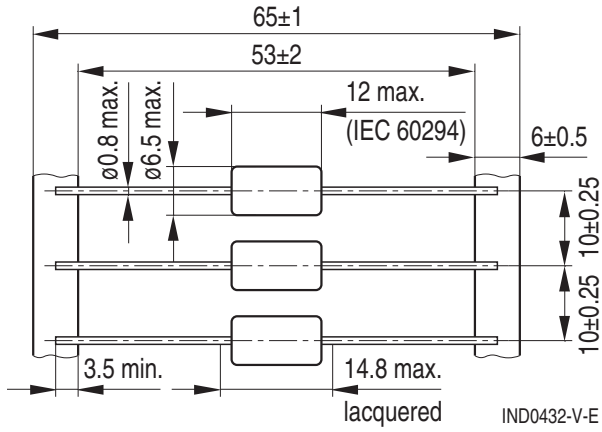

Dimensions in mm
Minimum lead spacing 15 mm

Packing

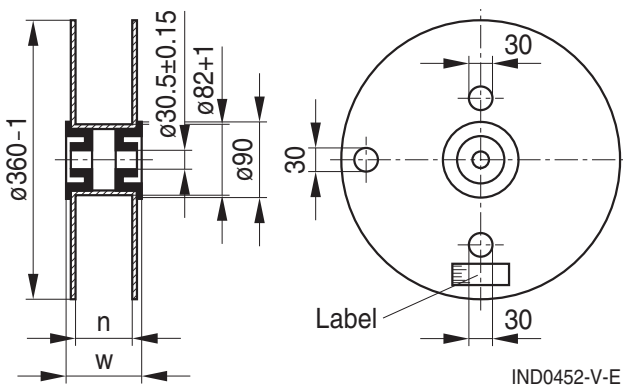

Dimensions in mm

n (mm): $72 + 1$
w (mm): 84 max

Technical data and measuring conditions

Rated inductance L_R	Measured with LCR meter Agilent 4284A or impedance analyzer Agilent 4294A Measuring frequency: $100 \mu\text{H} < L_R \leq 4700 \mu\text{H} = 100 \text{ kHz}$ $L_R > 4700 \mu\text{H} = 10 \text{ kHz}$ Measuring current: $\leq 1 \text{ mA}$ Measuring temperature: $+20 \text{ }^\circ\text{C}$
Q factor Q_{\min}	Measured with precision impedance analyzer Agilent 4294A, $+20 \text{ }^\circ\text{C}$
Rated temperature T_R	$+40 \text{ }^\circ\text{C}$
Rated current I_R	Maximum permissible DC current at rated temperature
Inductance decrease $\Delta L/L_0$	$\leq 10\%$ (referred to initial value) at I_R , $+20 \text{ }^\circ\text{C}$
DC resistance R_{\max}	Measured at $+20 \text{ }^\circ\text{C}$
Resonance frequency $f_{\text{res},\min}$	Measured with Agilent 4294A or 8753ES, $+20 \text{ }^\circ\text{C}$
Solderability (lead-free)	Sn95.5Ag3.8Cu0.7: $+(245 \pm 5) \text{ }^\circ\text{C}$, $(3 \pm 0.3) \text{ s}$ Wetting of soldering area $\geq 90\%$ (to IEC 60068-2-20, test Ta)
Resistance to soldering heat	$+(260 \pm 5) \text{ }^\circ\text{C}$, 10 s (to IEC 60068-2-20, test Tb)
Tensile strength of leads	$\geq 20 \text{ N}$ (to IEC 60068-2-21, test Ua)
Climatic category	55/125/56 (to IEC 60068-1)
Storage conditions	Mounted: $-55 \text{ }^\circ\text{C} \dots +125 \text{ }^\circ\text{C}$ Packaged: $-25 \text{ }^\circ\text{C} \dots +40 \text{ }^\circ\text{C}$, $\leq 75\% \text{ RH}$
Weight	Approx. 1.3 g

 **Mounting information**

When bending the leads, take care that the start-of-winding areas at the face ends (protected by glue and lacquer) are not subjected to any mechanical stress.

Characteristics and ordering codes

L_R μH	Tolerance ¹⁾	Q_{\min}	f_Q MHz	I_R mA	R_{\max} Ω	$f_{\text{res,min}}$ MHz	Ordering code
100	$\pm 5\% \triangle J$	50	0.796	860	0.70	3.5	B82145A1104J000
150		40	0.796	770	0.90	3.0	B82145A1154J000
220		30	0.796	690	1.10	2.5	B82145A1224J000
330		30	0.796	630	1.30	2.1	B82145A1334J000
470		30	0.796	510	1.90	1.8	B82145A1474J000
680		20	0.796	440	2.50	1.5	B82145A1684J000
1000		60	0.252	370	3.60	1.3	B82145A1105J000
1500		60	0.252	300	5.40	1.0	B82145A1155J000
2200		60	0.252	250	8.00	0.8	B82145A1225J000
3300		60	0.252	200	12.5	0.6	B82145A1335J000
4700		60	0.252	170	18.0	0.5	B82145A1475J000
6800		60	0.252	130	28.5	0.4	B82145A1685J000
10000		50	0.0796	110	35.0	0.35	B82145A1106J000

HLBC chokes with diameter 7.5 and 8.5 mm for even higher rated currents available on request.
 HLBC chokes with temperature range up to +140 °C available on request.

1) Closer tolerances on request.

Impedance $|Z|$ versus frequency f
 measured with impedance analyzer Agilent 4294A or S-parameter network analyzer Agilent 8753ES, typical values at +20 °C

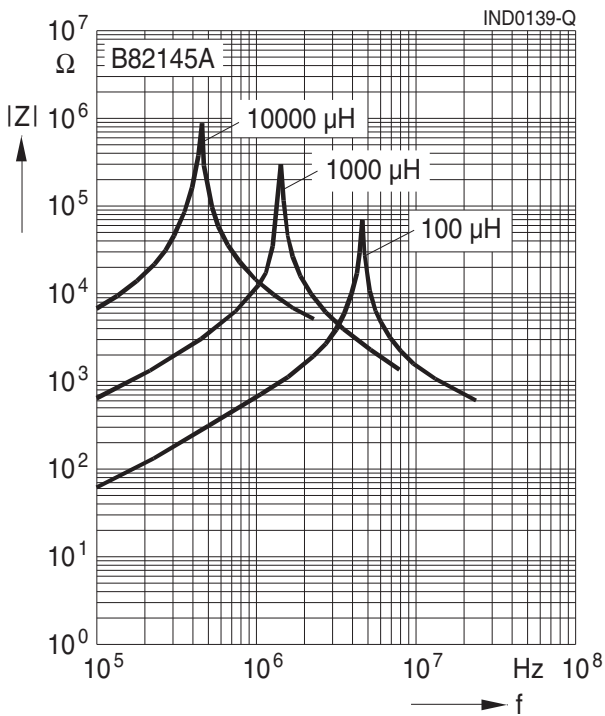

Inductance L versus DC load current I_{DC}
 measured with LCR meter Agilent 4284A, typical values at +20 °C

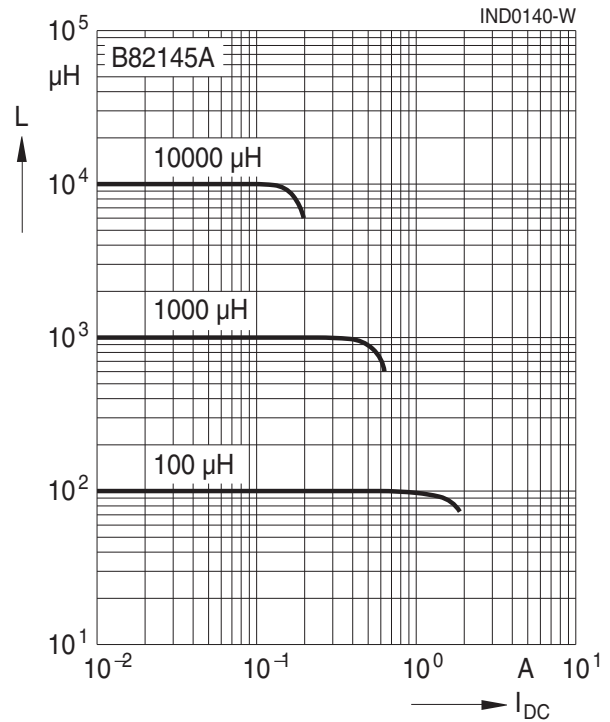

Q factor versus frequency f
 measured with impedance analyzer Agilent 4294A, typical values at +20 °C

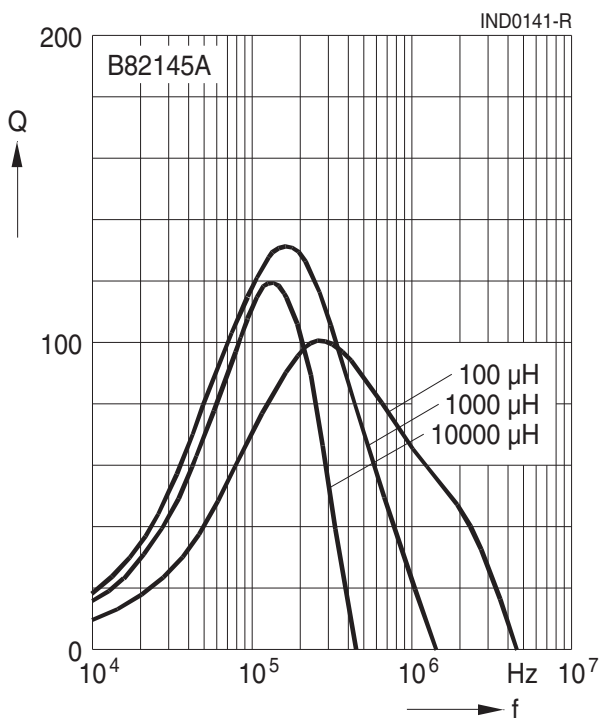

Current derating I_{op}/I_R versus ambient temperature T_A
 (rated temperature $T_R = +40$ °C)

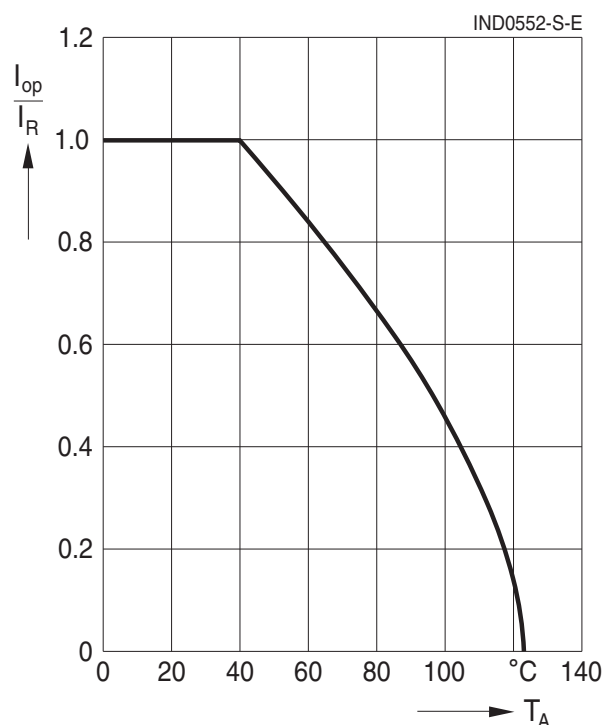

Cautions and warnings

- Please note the recommendations in our Inductors data book (latest edition) and in the data sheets.
 - Particular attention should be paid to the derating curves given there.
 - The soldering conditions should also be observed. Temperatures quoted in relation to wave soldering refer to the pin, not the housing.
- If the components are to be washed varnished it is necessary to check whether the washing varnish agent that is used has a negative effect on the wire insulation, any plastics that are used, or on glued joints. In particular, it is possible for washing varnish agent residues to have a negative effect in the long-term on wire insulation.
Washing processes may damage the product due to the possible static or cyclic mechanical loads (e.g. ultrasonic cleaning). They may cause cracks to develop on the product and its parts, which might lead to reduced reliability or lifetime.
- The following points must be observed if the components are potted in customer applications:
 - Many potting materials shrink as they harden. They therefore exert a pressure on the plastic housing or core. This pressure can have a deleterious effect on electrical properties, and in extreme cases can damage the core or plastic housing mechanically.
 - It is necessary to check whether the potting material used attacks or destroys the wire insulation, plastics or glue.
 - The effect of the potting material can change the high-frequency behaviour of the components.
- Ferrites are sensitive to direct impact. This can cause the core material to flake, or lead to breakage of the core.
- Even for customer-specific products, conclusive validation of the component in the circuit can only be carried out by the customer.

Important notes

The following applies to all products named in this publication:

1. Some parts of this publication contain **statements about the suitability of our products for certain areas of application**. These statements are based on our knowledge of typical requirements that are often placed on our products in the areas of application concerned. We nevertheless expressly point out **that such statements cannot be regarded as binding statements about the suitability of our products for a particular customer application**. As a rule, EPCOS is either unfamiliar with individual customer applications or less familiar with them than the customers themselves. For these reasons, it is always ultimately incumbent on the customer to check and decide whether an EPCOS product with the properties described in the product specification is suitable for use in a particular customer application.
2. We also point out that **in individual cases, a malfunction of electronic components or failure before the end of their usual service life cannot be completely ruled out in the current state of the art, even if they are operated as specified**. In customer applications requiring a very high level of operational safety and especially in customer applications in which the malfunction or failure of an electronic component could endanger human life or health (e.g. in accident prevention or life-saving systems), it must therefore be ensured by means of suitable design of the customer application or other action taken by the customer (e.g. installation of protective circuitry or redundancy) that no injury or damage is sustained by third parties in the event of malfunction or failure of an electronic component.
3. **The warnings, cautions and product-specific notes must be observed.**
4. In order to satisfy certain technical requirements, **some of the products described in this publication may contain substances subject to restrictions in certain jurisdictions (e.g. because they are classed as hazardous)**. Useful information on this will be found in our Material Data Sheets on the Internet (www.epcos.com/material). Should you have any more detailed questions, please contact our sales offices.
5. We constantly strive to improve our products. Consequently, **the products described in this publication may change from time to time**. The same is true of the corresponding product specifications. Please check therefore to what extent product descriptions and specifications contained in this publication are still applicable before or when you place an order.

We also **reserve the right to discontinue production and delivery of products**. Consequently, we cannot guarantee that all products named in this publication will always be available. The aforementioned does not apply in the case of individual agreements deviating from the foregoing for customer-specific products.

6. Unless otherwise agreed in individual contracts, **all orders are subject to the current version of the “General Terms of Delivery for Products and Services in the Electrical Industry” published by the German Electrical and Electronics Industry Association (ZVEI)**.
7. The trade names EPCOS, BAOKE, Alu-X, CeraDiode, CeraLink, CSMP, CSSP, CTVS, DeltaCap, DigiSiMic, DSSP, FilterCap, FormFit, MiniBlue, MiniCell, MKD, MKK, MLSC, MotorCap, PCC, PhaseCap, PhaseCube, PhaseMod, PhiCap, SIFERRIT, SIFI, SIKOREL, SilverCap, SIMDAD, SiMic, SIMID, SineFormer, SIOV, SIP5D, SIP5K, ThermoFuse, WindCap are **trademarks registered or pending** in Europe and in other countries. Further information will be found on the Internet at www.epcos.com/trademarks.