

## **PTC thermistors for overcurrent protection**

Leaded disks, uncoated, 380 to 1000 V

**Series/Type:** B597\*\*  
**Date:** July 2014

© EPCOS AG 2015. Reproduction, publication and dissemination of this publication, enclosures hereto and the information contained therein without EPCOS' prior express consent is prohibited.

EPCOS AG is a TDK Group Company.

## Overcurrent protection

Leaded disks, uncoated, 380 V to 1000 V

B750 ... B774

### Applications

- Overcurrent protection
- Short circuit protection

### Features

- Lead-free terminals
- Marking: Type, manufacturer's logo, reference temperature in °C and date code YYWW
- UL approval to UL 1434 with  $V_{max} = 420$  V and  $V_R = 380$  V (file number E69802), except B758
- VDE approval for selected types (licence number 104843 E)
- RoHS-compatible

### Delivery mode

- Cardboard strips (standard)
- Cardboard tape reeled or in Ammo pack on request

### Dimensional drawing

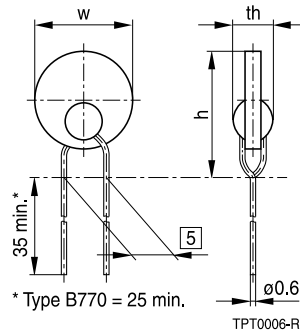



### Dimensions (mm)

Type	$w_{max}$	$h_{max}$	$th_{max}$
B750	12.5	16.5	5.0
B751	12.5	16.5	7.0
B752	12.5	16.5	7.0
B753	12.5	16.5	7.0
B754	12.5	16.5	7.0
B755	12.5	16.5	7.0
B758	12.5	16.5	7.0
B770	8.5	12.0	7.0
B771	8.5	12.0	7.0
B772	8.5	12.0	7.0
B773	8.5	12.0	7.0
B774	8.5	12.0	7.0

### General technical data

Switching cycles	N	100	
Operating temperature range ( $V = 0$ )	$T_{op}$	-40/+125	°C
Operating temperature range ( $V = V_{max}$ )	$T_{op}$	-20/+85	°C

**Overcurrent protection**
**Leaded disks, uncoated, 380 V to 1000 V**
**B750 ... B774**
**Electrical specifications and ordering codes**

Type	$I_R$ mA	$I_S$ mA	$I_{Smax}$ ( $V = V_{max}$ ) A	$t_S$ ( $V_{max}$ , $I_{Smax}$ ) s	$I_r$ (typ.) ( $V = V_{max}$ ) mA	$R_R$ $\Omega$	$R_{min}$ $\Omega$	Approvals  		Ordering code
$V_{max} = 440 \text{ V}$ , $V_R = 380 \text{ V}$ , $T_{ref} = 120 \text{ }^\circ\text{C}$ , $\Delta R_R = \pm 25 \%$										
B750	123	245	4.0	< 6	4.0	25	13	X	X	B59750B0120A070
B751	87	173	4.0	< 4	3.5	50	26	X	X	B59751B0120A070
B752	69	137	4.0	< 4	3.5	80	42	X	X	B59752B0120A070
B753	56	112	4.0	< 3	3.0	120	63	X	X	B59753B0120A070
B754	50	100	4.0	< 3	3.0	150	68	X	X	B59754B0120A070
B770	64	127	2.8	< 4	3.5	70	45	X	X	B59770B0120A070
B771	49	97	2.8	< 3	2.5	120	76	X	X	B59771B0120A070
B772	43	86	2.8	< 3	2.5	150	96	X	X	B59772B0120A070
$V_{max} = 550 \text{ V}$ , $V_R = 500 \text{ V}$ , $T_{ref} = 115 \text{ }^\circ\text{C}$ , $\Delta R_R = \pm 25 \%$										
B755	28	55	1.4	< 3	2.0	500	230	X	X	B59755B0115A070
B774	16	32	1.0	< 2	1.5	1100	700	X	X	B59774B0115A070
$V_{max} = 550 \text{ V}$ , $V_R = 500 \text{ V}$ , $T_{ref} = 120 \text{ }^\circ\text{C}$ , $\Delta R_R = \pm 25 \%$										
B773	24	48	1.0	< 3	2.0	500	320	X	X	B59773B0120A070
$V_{max} = 1000 \text{ V}$ , $V_R = 1000 \text{ V}$ , $T_{ref} = 110 \text{ }^\circ\text{C}$ , $\Delta R_R = \pm 33 \%$										
B758	8	17	0.5	< 3	3.0	7500	3380	–	–	B59758B0110A070

**Overcurrent protection**
**Leaded disks, uncoated, 380 V to 1000 V**
**B750 ... B774**
**Reliability data**

Test	Standard	Test conditions	$ \Delta R_{25}/R_{25} $
Electrical endurance, cycling	IEC 60738-1	Room temperature, $I_{Smax}$ ; $V_{max}$ Number of cycles: 100	< 25%
Electrical endurance, constant	IEC 60738-1	Storage at $V_{max}/T_{op,max}$ ( $V_{max}$ ) Test duration: 1000 h	< 25%
Damp heat	IEC 60738-1	Temperature of air: 40 °C Relative humidity of air: 93% Duration: 56 days Test according to IEC 60068-2-78	< 10%
Rapid change of temperature	IEC 60738-1	$T_1 = T_{op,min}$ (0 V), $T_2 = T_{op,max}$ (0 V) Number of cycles: 5 Test duration: 30 min Test according to IEC 60068-2-14, test Na	< 10%
Vibration	IEC 60738-1	Frequency range: 10 to 55 Hz Displacement amplitude: 0.75 mm Test duration: 3 × 2 h Test according to IEC 60068-2-6, test Fc	< 5%
Shock	IEC 60738-1	Acceleration: 390 m/s <sup>2</sup> Pulse duration: 6 ms; 6 × 4000 pulses	< 5%
Climatic sequence	IEC 60738-1	Dry heat: $T = T_{op,max}$ (0 V) Test duration: 16 h Damp heat first cycle Cold: $T = T_{op,min}$ (0 V) Test duration: 2 h Damp heat 5 cycles Tests performed according to IEC 60068-2-30	< 10%

## Overcurrent protection

Leaded disks, uncoated, 380 V to 1000 V

B750 ... B774

### Characteristics (typical)

PTC resistance  $R_{PTC}$  versus

PTC temperature  $T_{PTC}$

(measured at low signal voltage)

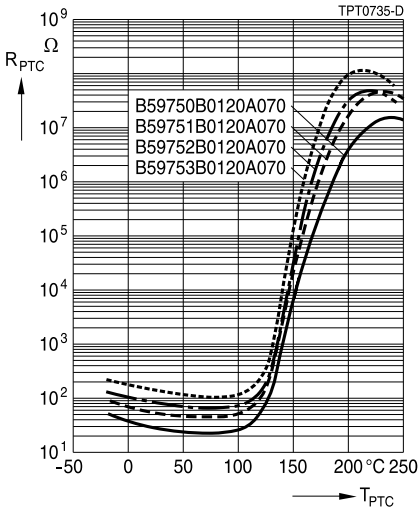

PTC current  $I_{PTC}$  versus PTC voltage  $V_{PTC}$

(measured at 25 °C in still air)

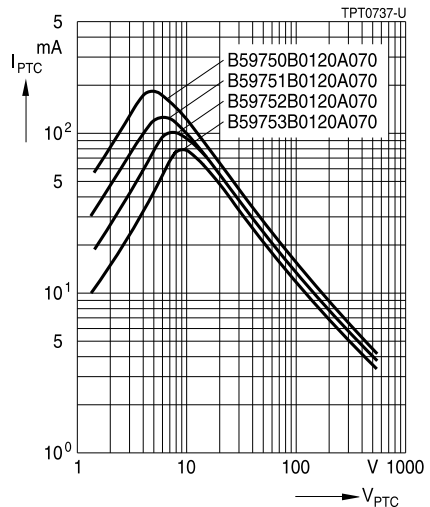

Switching time  $t_S$  versus switching current  $I_S$

(measured at 25 °C in still air)

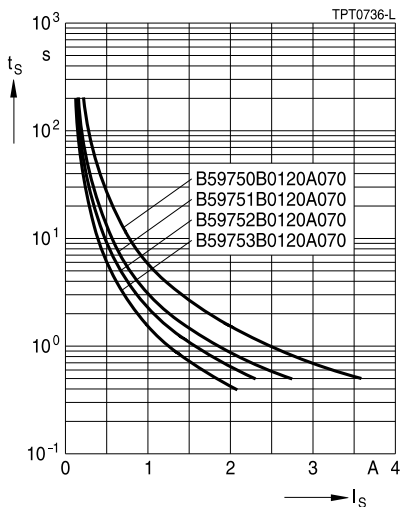

Rated current  $I_R$  versus ambient temperature  $T_A$

(measured in still air)

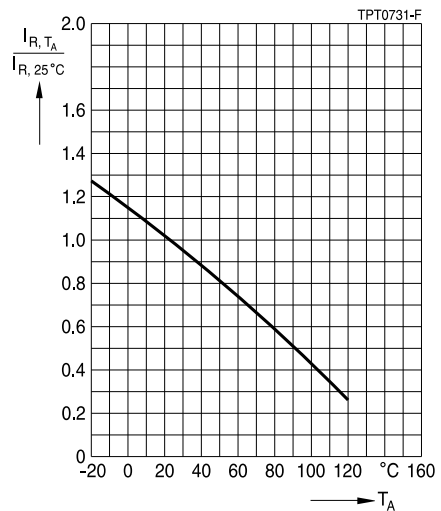

## Overcurrent protection

Leaded disks, uncoated, 380 V to 1000 V

B750 ... B774

### Characteristics (typical)

PTC resistance  $R_{PTC}$  versus

PTC temperature  $T_{PTC}$

(measured at low signal voltage)



PTC current  $I_{PTC}$  versus PTC voltage  $V_{PTC}$

(measured at 25 °C in still air)



Switching time  $t_s$  versus switching current  $I_s$

(measured at 25 °C in still air)



Rated current  $I_R$  versus ambient temperature  $T_A$

(measured in still air)



## Overcurrent protection

Leaded disks, uncoated, 380 V to 1000 V

B750 ... B774

### Characteristics (typical)

PTC resistance  $R_{PTC}$  versus  
PTC temperature  $T_{PTC}$   
(measured at low signal voltage)



PTC current  $I_{PTC}$  versus PTC voltage  $V_{PTC}$   
(measured at 25 °C in still air)

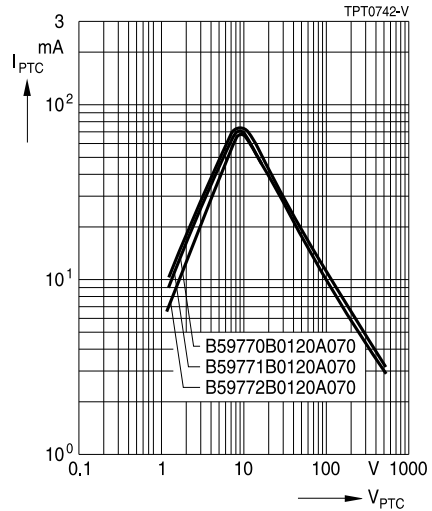

Switching time  $t_S$  versus switching current  $I_S$   
(measured at 25 °C in still air)



Rated current  $I_R$  versus ambient temperature  $T_A$   
(measured in still air)



## Overcurrent protection

Leaded disks, uncoated, 380 V to 1000 V

B750 ... B774

### Characteristics (typical)

PTC resistance  $R_{PTC}$  versus  
PTC temperature  $T_{PTC}$   
(measured at low signal voltage)

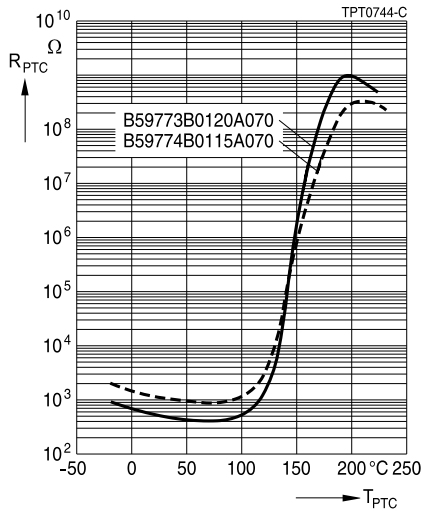

PTC current  $I_{PTC}$  versus PTC voltage  $V_{PTC}$   
(measured at 25 °C in still air)

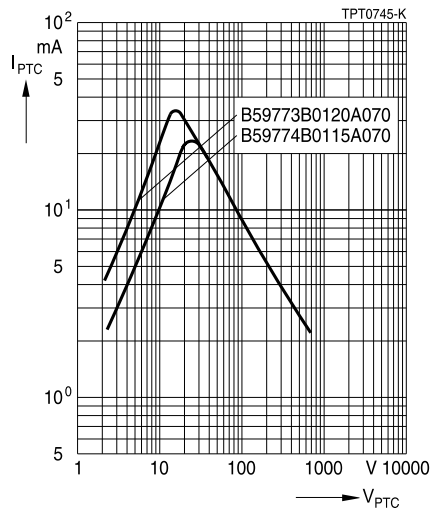

Switching time  $t_s$  versus switching current  $I_s$   
(measured at 25 °C in still air)

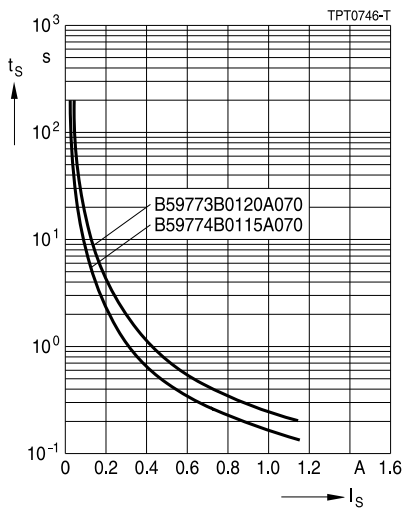

Rated current  $I_R$  versus ambient temperature  $T_A$   
(measured in still air)

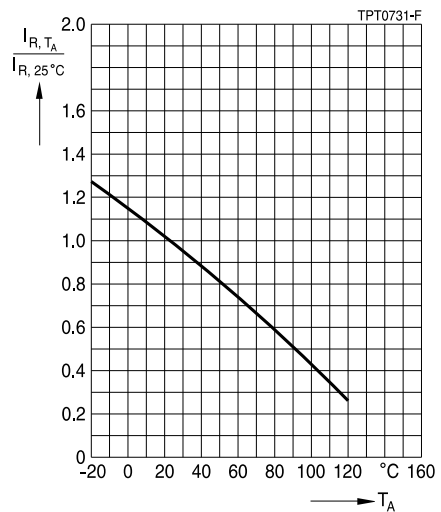



## Overcurrent protection

Leaded disks, uncoated, 380 V to 1000 V

B750 ... B774

### Cautions and warnings

#### General

- EPCOS thermistors are designed for specific applications and should not be used for purposes not identified in our specifications, application notes and data books unless otherwise agreed with EPCOS during the design-in-phase.
- Ensure suitability of thermistor through reliability testing during the design-in phase. The thermistors should be evaluated taking into consideration worst-case conditions.

#### Storage

- Store thermistors only in original packaging. Do not open the package before storage.
- Storage conditions in original packaging: storage temperature  $-25\text{ °C} \dots +45\text{ °C}$ , relative humidity  $\leq 75\%$  annual mean, maximum 95%, dew precipitation is inadmissible.
- Avoid contamination of thermistors surface during storage, handling and processing.
- Avoid storage of thermistor in harmful environment with effect on function on long-term operation (examples given under operation precautions).
- Use thermistor within the following period after delivery:
  - Through-hole devices (housed and leaded PTCs): 24 months
  - Motor protection sensors, glass-encapsulated sensors and probe assemblies: 24 months
  - Telecom pair and quattro protectors (TPP, TQP): 24 months
  - Leadless PTC thermistors for pressure contacting: 12 months
  - Leadless PTC thermistors for soldering: 6 months
  - SMDs in EIA sizes 3225 and 4032, and for PTCs with metal tags: 24 months
  - SMDs in EIA sizes 0402, 0603, 0805 and 1210: 12 months

#### Handling

- PTCs must not be dropped. Chip-offs must not be caused during handling of PTCs.
- Components must not be touched with bare hands. Gloves are recommended.
- Avoid contamination of thermistor surface during handling.

#### Soldering (where applicable)

- Use rosin-type flux or non-activated flux.
- Insufficient preheating may cause ceramic cracks.
- Rapid cooling by dipping in solvent is not recommended.
- Complete removal of flux is recommended.
- Standard PTC heaters are not suitable for soldering.

## Overcurrent protection

Leaded disks, uncoated, 380 V to 1000 V

B750 ... B774

### Mounting

- Electrode must not be scratched before/during/after the mounting process.
- Contacts and housing used for assembly with thermistor have to be clean before mounting. Especially grease or oil must be removed.
- When PTC thermistors are encapsulated with sealing material, the precautions given in chapter "Mounting instructions", "Sealing and potting" must be observed.
- When the thermistor is mounted, there must not be any foreign body between the electrode of the thermistor and the clamping contact.
- The minimum force of the clamping contacts pressing against the PTC must be 10 N.
- During operation, the thermistor's surface temperature can be very high. Ensure that adjacent components are placed at a sufficient distance from the thermistor to allow for proper cooling at the thermistors.
- Ensure that adjacent materials are designed for operation at temperatures comparable to the surface temperature of thermistor. Be sure that surrounding parts and materials can withstand this temperature.
- Avoid contamination of thermistor surface during processing.

### Operation

- Use thermistors only within the specified temperature operating range.
- Use thermistors only within the specified voltage and current ranges.
- Environmental conditions must not harm the thermistors. Use thermistors only in normal atmospheric conditions. Avoid use in deoxidizing gases (chlorine gas, hydrogen sulfide gas, ammonia gas, sulfuric acid gas etc), corrosive agents, humid or salty conditions. Contact with any liquids and solvents should be prevented.
- Be sure to provide an appropriate fail-safe function to prevent secondary product damage caused by abnormal function (e.g. use VDR for limitation of overvoltage condition).

This listing does not claim to be complete, but merely reflects the experience of EPCOS AG.

**Overcurrent protection**
**Leaded disks, uncoated, 380 V to 1000 V**
**B750 ... B774**
**Symbols and terms**

Symbol	Term
A	Area
C	Capacitance
$C_{th}$	Heat capacity
f	Frequency
I	Current
$I_{max}$	Maximum current
$I_R$	Rated current
$I_{res}$	Residual current
$I_{PTC}$	PTC current
$I_r$	Residual current
$I_{r,oil}$	Residual current in oil (for level sensors)
$I_{r,air}$	Residual current in air (for level sensors)
$I_{RMS}$	Root-mean-square value of current
$I_S$	Switching current
$I_{Smax}$	Maximum switching current
LCT	Lower category temperature
N	Number (integer)
$N_c$	Operating cycles at $V_{max}$ , charging of capacitor
$N_f$	Switching cycles at $V_{max}$ , failure mode
P	Power
$P_{25}$	Maximum power at 25 °C
$P_{el}$	Electrical power
$P_{diss}$	Dissipation power
$R_G$	Generator internal resistance
$R_{min}$	Minimum resistance
$R_R$	Rated resistance
$\Delta R_R$	Tolerance of $R_R$
$R_P$	Parallel resistance
$R_{PTC}$	PTC resistance
$R_{ref}$	Reference resistance
$R_S$	Series resistance
$R_{25}$	Resistance at 25 °C
$R_{25,match}$	Resistance matching per reel/ packing unit at 25 °C
$\Delta R_{25}$	Tolerance of $R_{25}$
T	Temperature
t	Time
$T_A$	Ambient temperature

## Overcurrent protection

Leaded disks, uncoated, 380 V to 1000 V

B750 ... B774

$t_a$	Thermal threshold time
$T_C$	Ferroelectric Curie temperature
$t_E$	Settling time (for level sensors)
$T_R$	Rated temperature
$T_{sense}$	Sensing temperature
$T_{op}$	Operating temperature
$T_{PTC}$	PTC temperature
$t_R$	Response time
$T_{ref}$	Reference temperature
$T_{Rmin}$	Temperature at minimum resistance
$t_S$	Switching time
$T_{surf}$	Surface temperature
UCT	Upper category temperature
V or $V_{el}$	Voltage (with subscript only for distinction from volume)
$V_{c(max)}$	Maximum DC charge voltage of the surge generator
$V_{F,max}$	Maximum voltage applied at fault conditions in protection mode
$V_{RMS}$	Root-mean-square value of voltage
$V_{BD}$	Breakdown voltage
$V_{ins}$	Insulation test voltage
$V_{link,max}$	Maximum link voltage
$V_{max}$	Maximum operating voltage
$V_{max,dyn}$	Maximum dynamic (short-time) operating voltage
$V_{meas}$	Measuring voltage
$V_{meas,max}$	Maximum measuring voltage
$V_R$	Rated voltage
$V_{PTC}$	Voltage drop across a PTC thermistor
$\alpha$	Temperature coefficient
$\Delta$	Tolerance, change
$\delta_{th}$	Dissipation factor
$\tau_{th}$	Thermal cooling time constant
$\lambda$	Failure rate
$e$	Lead spacing (in mm)

### Abbreviations / Notes

**SMD** Surface-mount devices

\* To be replaced by a number in ordering codes, type designations etc.

+ To be replaced by a letter

All dimensions are given in mm.

The commas used in numerical values denote decimal points.

## Important notes

The following applies to all products named in this publication:

1. Some parts of this publication contain **statements about the suitability of our products for certain areas of application**. These statements are based on our knowledge of typical requirements that are often placed on our products in the areas of application concerned. We nevertheless expressly point out **that such statements cannot be regarded as binding statements about the suitability of our products for a particular customer application**. As a rule, EPCOS is either unfamiliar with individual customer applications or less familiar with them than the customers themselves. For these reasons, it is always ultimately incumbent on the customer to check and decide whether an EPCOS product with the properties described in the product specification is suitable for use in a particular customer application.
2. We also point out that **in individual cases, a malfunction of electronic components or failure before the end of their usual service life cannot be completely ruled out in the current state of the art, even if they are operated as specified**. In customer applications requiring a very high level of operational safety and especially in customer applications in which the malfunction or failure of an electronic component could endanger human life or health (e.g. in accident prevention or lifesaving systems), it must therefore be ensured by means of suitable design of the customer application or other action taken by the customer (e.g. installation of protective circuitry or redundancy) that no injury or damage is sustained by third parties in the event of malfunction or failure of an electronic component.
3. **The warnings, cautions and product-specific notes must be observed.**
4. In order to satisfy certain technical requirements, **some of the products described in this publication may contain substances subject to restrictions in certain jurisdictions (e.g. because they are classed as hazardous)**. Useful information on this will be found in our Material Data Sheets on the Internet ([www.epcos.com/material](http://www.epcos.com/material)). Should you have any more detailed questions, please contact our sales offices.
5. We constantly strive to improve our products. Consequently, **the products described in this publication may change from time to time**. The same is true of the corresponding product specifications. Please check therefore to what extent product descriptions and specifications contained in this publication are still applicable before or when you place an order. We also **reserve the right to discontinue production and delivery of products**. Consequently, we cannot guarantee that all products named in this publication will always be available. The aforementioned does not apply in the case of individual agreements deviating from the foregoing for customer-specific products.
6. Unless otherwise agreed in individual contracts, **all orders are subject to the current version of the "General Terms of Delivery for Products and Services in the Electrical Industry" published by the German Electrical and Electronics Industry Association (ZVEI)**.
7. The trade names EPCOS, Alu-X, CeraDiode, CeraLink, CeraPlas, CSMP, CSSP, CTVS, DeltaCap, DigiSiMic, DSSP, FilterCap, FormFit, MiniBlue, MiniCell, MKD, MKK, MLSC, MotorCap, PCC, PhaseCap, PhaseCube, PhaseMod, PhiCap, PQSine, SIFERRIT, SIFI, SIKOREL, SilverCap, SIMDAD, SiMic, SIMID, SineFormer, SIOV, SIP5D, SIP5K, TFAP, ThermoFuse, WindCap are **trademarks registered or pending** in Europe and in other countries. Further information will be found on the Internet at [www.epcos.com/trademarks](http://www.epcos.com/trademarks).