

## **SIOV metal oxide varistors**

Strap varistors, HighE, standard, LS40 series

**Series/Type:** B722\*  
**Date:** April 2011

© EPCOS AG 2015. Reproduction, publication and dissemination of this publication, enclosures hereto and the information contained therein without EPCOS' prior express consent is prohibited.

EPCOS AG is a TDK Group Company.

**HighE, standard, LS40 series**
**Construction**

- Rectangular varistor element as in SIOV-B40
- Coating: epoxy resin, flame-retardant to UL 94 V-0
- Bolt-holed strap terminals for screw fixing or soldering
- Bent or straight strap terminals

**Features**

- High surge current up to 40 kA
- Wide operating voltage range 130 ... 750 V<sub>RMS</sub>
- PSpice models

**Approvals**

- UL
- CSA
- CECC (K150 ... K385)

**Delivery mode**

- Vacuum-packed styrofoam box

**General technical data**

Climatic category	to IEC 60068-1	40/85/56	
Operating temperature	to CECC 42 000	-25 ... + 85	°C
Storage temperature		-25 ... +110	°C
Electric strength	to CECC 42 000	≥ 2.5	kV <sub>RMS</sub>
Insulation resistance	to CECC 42 000	≥ 10	MΩ
Response time		< 25	ns

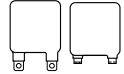
**Strap varistors**
**B722\***
**HighE, standard, LS40 series**

**Electrical specifications and ordering codes**
**Maximum ratings ( $T_A = 85\text{ }^\circ\text{C}$ )**

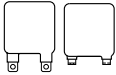
Ordering code	Type	$V_{RMS}$	$V_{DC}$	$i_{max}$ (8/20 $\mu\text{s}$ )	$W_{max}$ (2 ms)	$P_{max}$
	SIOV-	V	V	A	J	W
<b>Bent strap terminals</b>						
B72240L0131K100	LS40K130QP	130	170	40000	310	1.4
B72240L0141K100	LS40K140QP	140	180	40000	340	1.4
B72240L0151K100	LS40K150QP	150	200	40000	360	1.4
B72240L0231K100	LS40K230QP	230	300	40000	460	1.4
B72240L0251K100	LS40K250QP	250	320	40000	490	1.4
B72240L0271K100	LS40K275QP	275	350	40000	550	1.4
B72240L0321K100	LS40K320QP	320	420	40000	640	1.4
B72240L0381K100	LS40K385QP	385	505	40000	800	1.4
B72240L0421K100	LS40K420QP	420	560	40000	910	1.4
B72240L0441K100	LS40K440QP	440	585	40000	950	1.4
B72240L0461K100	LS40K460QP	460	615	40000	960	1.4
B72240L0551K100	LS40K550QP	550	745	40000	960	1.4
B72240L0681K100	LS40K680QP	680	895	40000	1100	1.4
B72240L0751K100	LS40K750QP	750	970	40000	1200	1.4
<b>Straight strap terminals</b>						
B72240L0131K102	LS40K130QPK2	130	170	40000	310	1.4
B72240L0141K102	LS40K140QPK2	140	180	40000	340	1.4
B72240L0151K102	LS40K150QPK2	150	200	40000	360	1.4
B72240L0231K102	LS40K230QPK2	230	300	40000	460	1.4
B72240L0251K102	LS40K250QPK2	250	320	40000	490	1.4
B72240L0271K102	LS40K275QPK2	275	350	40000	550	1.4
B72240L0321K102	LS40K320QPK2	320	420	40000	640	1.4
B72240L0381K102	LS40K385QPK2	385	505	40000	800	1.4
B72240L0421K102	LS40K420QPK2	420	560	40000	910	1.4
B72240L0441K102	LS40K440QPK2	440	585	40000	950	1.4
B72240L0461K102	LS40K460QPK2	460	615	40000	960	1.4
B72240L0551K102	LS40K550QPK2	550	745	40000	960	1.4
B72240L0681K102	LS40K680QPK2	680	895	40000	1100	1.4
B72240L0751K102	LS40K750QPK2	750	970	40000	1200	1.4

**Strap varistors**
**B722\***
**HighE, standard, LS40 series**
**Characteristics (T<sub>A</sub> = 25 °C)**

Ordering code	V <sub>v</sub> (1 mA) V	ΔV <sub>v</sub> (1 mA) %	V <sub>c,max</sub> (i <sub>c</sub> ) V	i <sub>c</sub> A	C <sub>typ</sub> (1 kHz) pF
<b>Bent strap terminals</b>					
B72240L0131K100	205	±10	340	300	5600
B72240L0141K100	220	±10	365	300	5200
B72240L0151K100	240	±10	395	300	4800
B72240L0231K100	360	±10	595	300	3200
B72240L0251K100	390	±10	650	300	2900
B72240L0271K100	430	±10	710	300	2700
B72240L0321K100	510	±10	840	300	2300
B72240L0381K100	620	±10	1025	300	1900
B72240L0421K100	680	±10	1120	300	1800
B72240L0441K100	715	±10	1180	300	1700
B72240L0461K100	750	±10	1240	300	1600
B72240L0551K100	910	±10	1500	300	1400
B72240L0681K100	1100	±10	1815	300	1100
B72240L0751K100	1200	±10	2000	300	1000
<b>Straight strap terminals</b>					
B72240L0131K102	205	±10	340	300	5600
B72240L0141K102	220	±10	365	300	5200
B72240L0151K102	240	±10	395	300	4800
B72240L0231K102	360	±10	595	300	3200
B72240L0251K102	390	±10	650	300	2900
B72240L0271K102	430	±10	710	300	2700
B72240L0321K102	510	±10	840	300	2300
B72240L0381K102	620	±10	1025	300	1900
B72240L0421K102	680	±10	1120	300	1800
B72240L0441K102	715	±10	1180	300	1700
B72240L0461K102	750	±10	1240	300	1600
B72240L0551K102	910	±10	1500	300	1400
B72240L0681K102	1100	±10	1815	300	1100
B72240L0751K102	1200	±10	2000	300	1000

Varistor elements without coating (suitable for soldering) are available upon request.

Designation: B72240D\*\*\*K\*\*\*

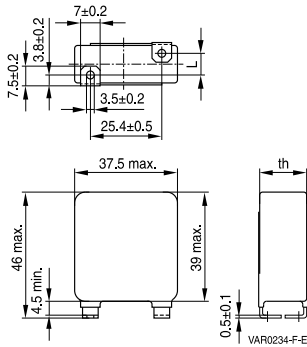
**Dimensional drawings**
**Bent strap terminals**

SIOV-LS40K ... QP

Weight: 20 ... 50 g

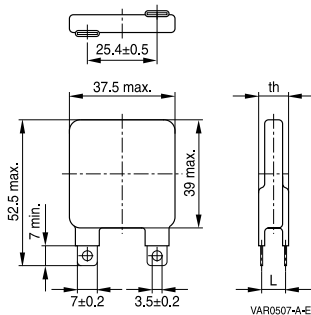
**Straight strap terminals**

SIOV-LS40K ... QPK2

Weight: 20 ... 50 g

Ordering code	th <sub>max</sub> mm	L ±1.0 mm
<b>Bent strap terminals</b>		
B72240L0131K100	8.1	-3.5
B72240L0141K100	8.2	-3.3
B72240L0151K100	8.3	-3.2
B72240L0231K100	9.0	-2.0
B72240L0251K100	9.2	-1.8
B72240L0271K100	9.4	-1.6
B72240L0321K100	9.9	-1.1
B72240L0381K100	10.6	-0.4
B72240L0421K100	10.9	0.0
B72240L0441K100	11.1	0.2
B72240L0461K100	11.4	0.4
B72240L0551K100	12.3	1.2
B72240L0681K100	13.5	2.4
B72240L0751K100	14.1	3.0
<b>Straight strap terminals</b>		
B72240L0131K102	8.1	4.4
B72240L0141K102	8.2	4.5
B72240L0151K102	8.3	4.6
B72240L0231K102	9.0	5.4
B72240L0251K102	9.2	5.6
B72240L0271K102	9.4	5.8
B72240L0321K102	9.9	6.3
B72240L0381K102	10.6	6.9
B72240L0421K102	10.9	7.3
B72240L0441K102	11.1	7.6
B72240L0461K102	11.4	7.8
B72240L0551K102	12.3	8.8
B72240L0681K102	13.5	9.9
B72240L0751K102	14.1	10.5

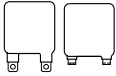

**Strap varistors**
**B722\***
**HighE, standard, LS40 series**
**Reliability data**

Test	Test methods/conditions	Requirement
Varistor voltage	The voltage between two terminals with the specified measuring current applied is called $V_V$ (1 mA <sub>DC</sub> @ 0.2 ... 2 s).	To meet the specified value
Clamping voltage	The maximum voltage between two terminals with the specified standard impulse current (8/20 $\mu$ s) applied.	To meet the specified value
Max. DC operating voltage	The maximum allowable DC operating voltage $V_{DC}$ at UCT +5/-0 °C is applied for 1000 $\pm$ 48 h. The leakage current $I_{leak}$ (t) during test is recorded. Then the specimen shall be stored at room temperature and normal humidity for 1 to 2 h. Thereafter, the change of $V_V$ shall be measured.	$I_{leak}$ (t = 1000 h) $\leq$ $I_{leak}$ (t = 0 h) $ \Delta V/V$ (1 mA) $\leq$ 10%
Surge current derating, 8/20 $\mu$ s	10 surge currents (8/20 $\mu$ s), unipolar, interval $\geq$ 60 s, amplitude corresponding to derating curve for 10 impulses at 20 $\mu$ s	$ \Delta V/V$ (1 mA) $\leq$ 10% (measured in direction of surge current) No visible damage
Fast temperature cycling	IEC 60068-2-14, test Na, LCT/UCT, dwell time 30 min, 5 cycles	$ \Delta V/V$ (1 mA) $\leq$ 10% No visible damage
Damp heat, steady state	IEC 60068-2-78 The specimen shall be subjected to 40 $\pm$ 2 °C, 90 to 95% r. H. for 56 $\pm$ 2 days with 10% of the maximum continuous DC operating voltage $V_{DC}$ . Then stored at room temperature and normal humidity for 1 to 2 h. Thereafter, the change of $V_V$ shall be measured.	$ \Delta V/V$ (1 mA) $\leq$ 10%

**Note:**

UCT = Upper category temperature

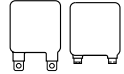
LCT = Lower category temperature

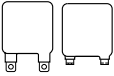

**Reliability data for CECC approved types**

Test	Test methods/conditions	Requirement
Varistor voltage	The voltage between two terminals with the specified measuring current applied is called $V_V$ (1 mA <sub>DC</sub> @ 0.2 ... 2 s).	To meet the specified value
Clamping voltage	The maximum voltage between two terminals with the specified standard impulse current (8/20 $\mu$ s) applied.	To meet the specified value
Max. DC operating voltage	CECC 42 000, test 4.20 1000 h at UCT  After having continuously applied the maximum allowable voltage at UCT $\pm 2$ °C for 1000 h, the specimen shall be stored at room temperature and normal humidity for 1 to 2 h. Thereafter, the change of $V_V$ shall be measured. Thereafter, insulation resistance $R_{ins}$ shall be measured according to CECC 42 000, test 4.8 at $V = 500$ V.	$ \Delta V/V (1 \text{ mA})  \leq 10\%$ $R_{ins} \geq 10 \text{ M}\Omega$
Surge current derating, 8/20 $\mu$ s	CECC 42 000, test C 2.1 100 surge currents (8/20 $\mu$ s), unipolar, interval 30 s, amplitude corresponding to derating curve for 100 impulses at 20 $\mu$ s	$ \Delta V/V (1 \text{ mA})  \leq 10\%$ (measured in direction of surge current) No visible damage
Surge current derating, 2 ms	CECC 42 000, test C 2.1 100 surge currents (2 ms), unipolar, interval 120 s, amplitude corresponding to derating curve for 100 impulses at 2 ms	$ \Delta V/V (1 \text{ mA})  \leq 10\%$ (measured in direction of surge current) No visible damage
Electric strength	CECC 42 000, test 4.7 Metal balls method, 2500 V <sub>RMS</sub> , 60 s The varistor is placed in a container holding 1.6 $\pm$ 0.2 mm diameter metal balls such that only the terminations of the varistor are protruding. The specified voltage shall be applied between both terminals of the specimen connected together and the electrode inserted between the metal balls.	No breakdown

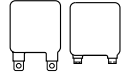

**Strap varistors**
**B722\***
**HighE, standard, LS40 series**

Test	Test methods/conditions	Requirement
Climatic sequence	<p>CECC 42 000, test 4.16</p> <p>The specimen shall be subjected to:</p> <p>a) dry heat at UCT, 16 h</p> <p>b) damp heat, 1st cycle: 55 °C/25 °C, 93 % r. H., 24 h</p> <p>c) cold, LCT, 2 h</p> <p>d) damp heat, additional 5 cycles: 55 °C/25 °C, 93 % r. H., 24 h/cycle.</p> <p>Then the specimen shall be stored at room temperature and normal humidity for 1 to 2 h.</p> <p>Thereafter, the change of <math>V_v</math> shall be measured.</p> <p>Thereafter, insulation resistance <math>R_{ins}</math> shall be measured according to CECC 42 000, test 4.8 at <math>V = 500</math> V.</p>	<p><math> \Delta V/V (1 \text{ mA})  \leq 10\%</math></p> <p><math>R_{ins} \geq 1 \text{ M}\Omega</math></p>
Fast temperature cycling	<p>IEC 60068-2-14, test Na, LCT/UCT, dwell time 30 min, 5 cycles</p>	<p><math> \Delta V/V (1 \text{ mA})  \leq 5\%</math></p> <p>No visible damage</p>
Damp heat, steady state	<p>The specimen shall be subjected to <math>40 \pm 2</math> °C, 90 to 95% r. H. for 56 days without load / with 10% of the maximum continuous DC operating voltage <math>V_{DC}</math>.</p> <p>Then stored at room temperature and normal humidity for 1 to 2 h.</p> <p>Thereafter, the change of <math>V_v</math> shall be measured.</p> <p>Thereafter, insulation resistance <math>R_{ins}</math> shall be measured according to CECC 42 000, test 4.8 at <math>V = 500</math> V</p>	<p><math> \Delta V/V (1 \text{ mA})  \leq 10\%</math></p> <p><math>R_{ins} \geq 1 \text{ M}\Omega</math></p>



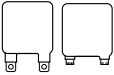

Test	Test methods/conditions	Requirement
Solderability	IEC 60068-2-20, test Ta, method 1 with modified conditions for lead-free solder alloys: 245 °C, 3 s: After dipping the terminals to a depth of approximately 3 mm from the body in a soldering bath of 245 °C for 3 s, the terminals shall be visually examined.	The inspection shall be carried out under adequate light with normal eyesight or with the assistance of a magnifier capable of giving a magnification of 4 to 10 times. The dipped surface shall be covered with a smooth and bright solder coating with no more than small amounts of scattered imperfections such as pinholes or un-wetted or de-wetted areas. These imperfections shall not be concentrated in one area.
Resistance to soldering heat	IEC 60068-2-20, test Tb, method 1A, 260 °C, 10 s:  Each lead shall be dipped into a solder bath having a temperature of 260 ±5 °C to a point 2.0 to 2.5 mm from the body of the unit, be held there for 10 ±1 s and then be stored at room temperature and normal humidity for 1 to 2 h. The change of $V_V$ shall be measured and the specimen shall be visually examined.	$ \Delta V/V (1 \text{ mA})  \leq 5\%$ No visible damage
Tensile strength	IEC 60068-2-21, test Ua1  After gradually applying the force specified below and keeping the unit fixed for 10 s, the terminal shall be visually examined for any damage. Force = 20 N	$ \Delta V/V (1 \text{ mA})  \leq 5\%$ No break of solder joint, no wire break
Vibration	IEC 60068-2, test Fc frequency range: 10 ... 55 Hz amplitude: 0.75 mm or 98 m/s <sup>2</sup> duration: 6 h (3 · 2 h) pulse: sine wave  After repeatedly applying a single harmonic vibration according to the table below. The change of $V_V$ and mechanical damages shall be examined.	$ \Delta V/V (1 \text{ mA})  \leq 5 \%$ No visible damage

**Strap varistors**
**B722\***
**HighE, standard, LS40 series**

Test	Test methods/conditions	Requirement
Shock	IEC 60068-2-27, test Ea pulse duration: 11 ms max. acceleration: 490 m/s <sup>2</sup> number of shocks: 6 · 3 pulse: half sine	$ \Delta V/V (1 \text{ mA})  \leq 5\%$ No visible damage
Flammability	IEC 60695-2-2 (needle flame test) Severity: vertical 10 s	5 s max.

**Note:**

UCT = Upper category temperature

LCT = Lower category temperature

 $R_{ins}$  = Insulation resistance to CECC 42 000, test 4.8

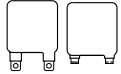

**v/i characteristics**

$v = f(i)$  for explanation of the characteristics refer to "General technical information", chapter 1.6.3  
 A = Leakage current, B = Protection level } for worst-case varistor tolerances

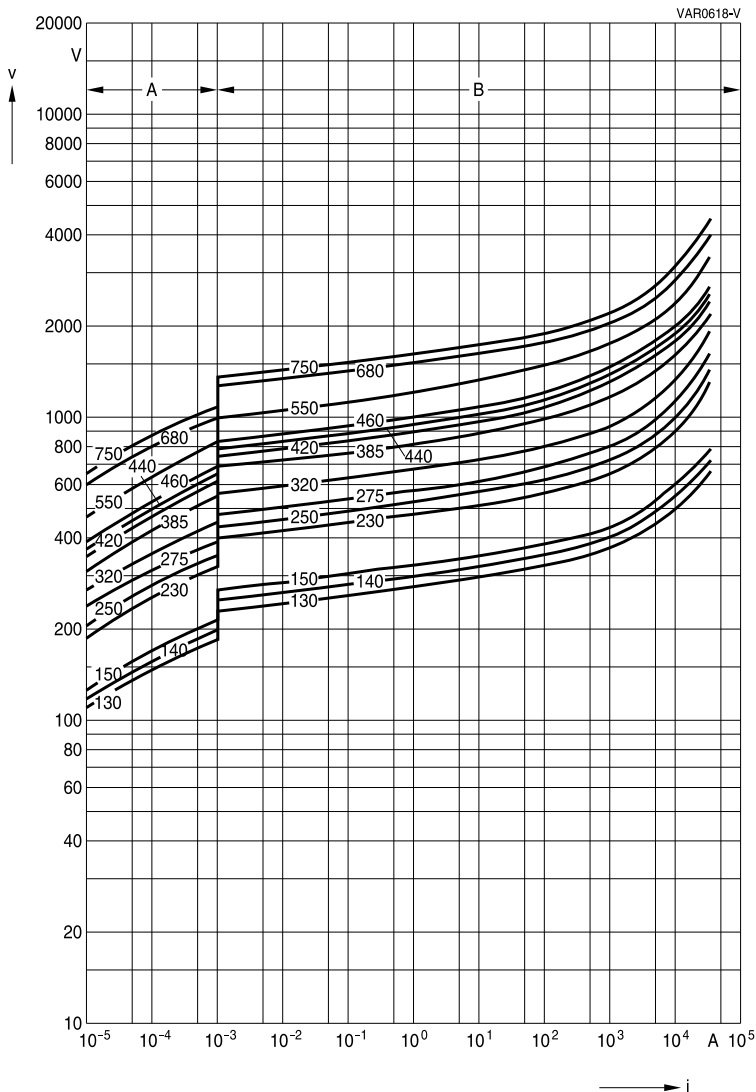

**SIOV-LS40K130QP(K2) ... K750QP(K2)**

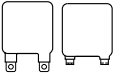

**Derating curves**

Maximum surge current  $i_{max} = f(t_r, \text{pulse train})$

For explanation of the derating curves refer to "General technical information", section 1.8.1

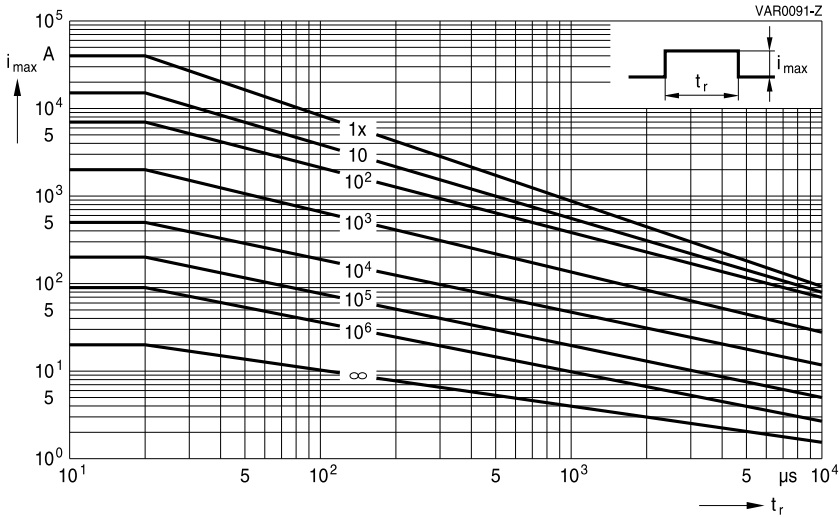

**SIOV-LS40K130QP(K2) ... K150QP(K2)**

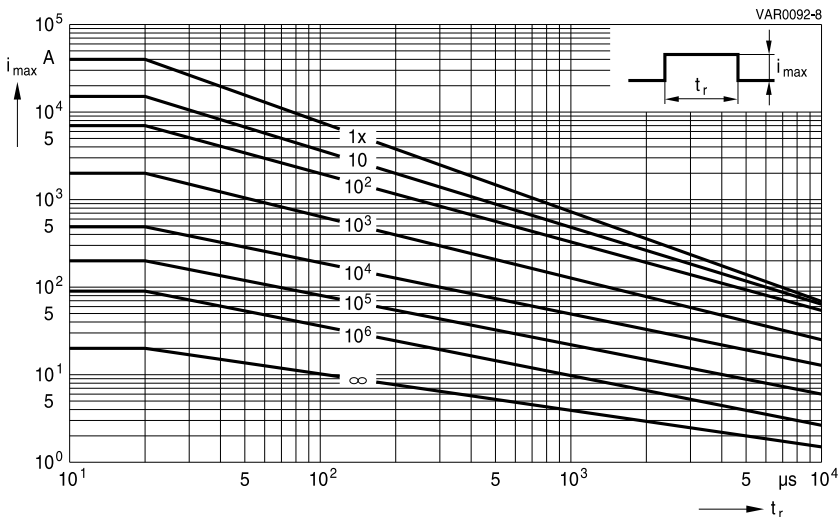

**SIOV-LS40K230QP(K2) ... K460QP(K2)**

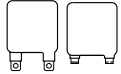

**Derating curves**

Maximum surge current  $i_{max} = f(t_r, \text{pulse train})$

For explanation of the derating curves refer to "General technical information", section 1.8.1

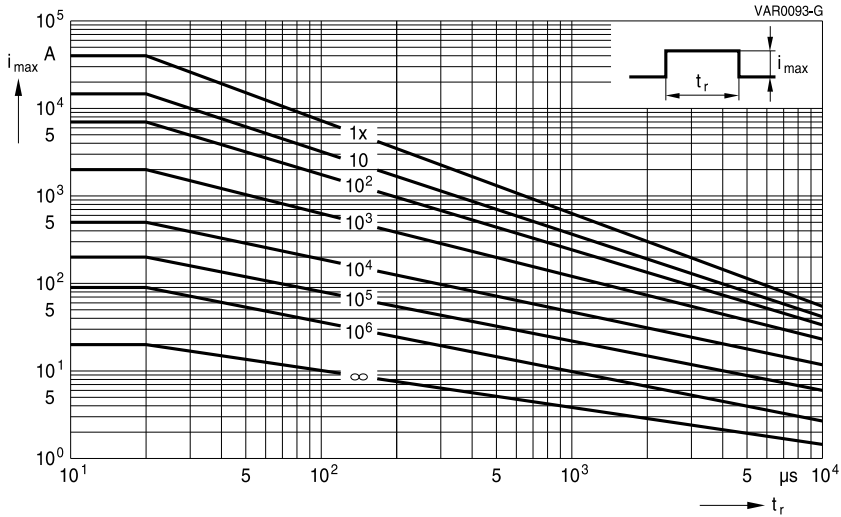

**SIOV-LS40K550QP(K2) ... K750QP(K2)**

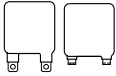

## Cautions and warnings

### General

1. EPCOS metal oxide varistors are designed for specific applications and should not be used for purposes not identified in our specifications, application notes and data books unless otherwise agreed with EPCOS during the design-in-phase.
2. Ensure suitability of SIOVs through reliability testing during the design-in phase. SIOVs should be evaluated taking into consideration worst-case conditions.
3. For applications of SIOVs in line-to-ground circuits based on various international and local standards there are restrictions existing or additional safety measures required.

### Storage

1. Store SIOVs only in original packaging. Do not open the package before storage.
2. Storage conditions in original packaging:  
 Storage temperature:  $-25\text{ }^{\circ}\text{C} \dots +45\text{ }^{\circ}\text{C}$ ,  
 Relative humidity:  $<75\%$  annual average,  
 $<95\%$  on maximum 30 days a year.  
 Dew precipitation: is to be avoided.
3. Avoid contamination of an SIOV's during storage, handling and processing.
4. Avoid storage of SIOVs in harmful environments that can affect the function during long-term operation (examples given under operation precautions).
5. The SIOV type series should be soldered within the time specified:
 

SIOV-S, -Q, -LS, -B, -SFS	24 months
ETFV	12 months.

### Handling

1. SIOVs must not be dropped.
2. Components must not be touched with bare hands. Gloves are recommended.
3. Avoid contamination of the surface of SIOV electrodes during handling, be careful of the sharp edge of SIOV electrodes.

### Soldering (where applicable)

1. Use rosin-type flux or non-activated flux.
2. Insufficient preheating may cause ceramic cracks.
3. Rapid cooling by dipping in solvent is not recommended.
4. Complete removal of flux is recommended.

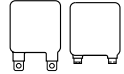

### Mounting

1. Potting, sealing or adhesive compounds can produce chemical reactions in the SIOV ceramic that will degrade the component's electrical characteristics.
2. Overloading SIOVs may result in ruptured packages and expulsion of hot materials. For this reason SIOVs should be physically shielded from adjacent components.

### Operation

1. Use SIOVs only within the specified temperature operating range.
2. Use SIOVs only within the specified voltage and current ranges.
3. Environmental conditions must not harm SIOVs. Use SIOVs only in normal atmospheric conditions. Avoid use in deoxidizing gases (chlorine gas, hydrogen sulfide gas, ammonia gas, sulfuric acid gas etc), corrosive agents, humid or salty conditions. Contact with any liquids and solvents should be prevented.

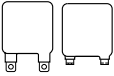
**Symbols and terms**

Symbol	Term
C	Capacitance
$C_{typ}$	Typical capacitance
i	Current
$i_c$	Current at which $V_{c, max}$ is measured
$I_{leak}$	Leakage current
$i_{max}$	Maximum surge current (also termed peak current)
$I_{max}$	Maximum discharge current to IEC 61643-1
$I_{nom}$	Nominal discharge current to IEC 61643-1
LCT	Lower category temperature
$L_{typ}$	Typical inductance
$P_{max}$	Maximum average power dissipation
$R_{ins}$	Insulation resistance
$R_{min}$	Minimum resistance
$T_A$	Ambient temperature
$t_r$	Duration of equivalent rectangular wave
UCT	Upper category temperature
v	Voltage
$V_{clamp}$	Clamping voltage
$V_{c, max}$	Maximum clamping voltage at specified current $i_c$
$V_{DC}$	DC operating voltage
$V_{jump}$	Maximum jump start voltage
$V_{max}$	Maximum voltage
$V_{op}$	Operating voltage
$V_{RMS}$	AC operating voltage, root-mean-square value
$V_{RMS, op, max}$	Root-mean-square value of max. DC operating voltage incl. ripple current
$V_{surge}$	Super imposed surge voltage
$V_V$	Varistor voltage
$\Delta V_V$	Tolerance of varistor voltage
$W_{LD}$	Maximum load dump
$W_{max}$	Maximum energy absorption
$e$	Lead spacing

All dimensions are given in mm.

The commas used in numerical values denote decimal points.



## Important notes

The following applies to all products named in this publication:

1. Some parts of this publication contain **statements about the suitability of our products for certain areas of application**. These statements are based on our knowledge of typical requirements that are often placed on our products in the areas of application concerned. We nevertheless expressly point out **that such statements cannot be regarded as binding statements about the suitability of our products for a particular customer application**. As a rule, EPCOS is either unfamiliar with individual customer applications or less familiar with them than the customers themselves. For these reasons, it is always ultimately incumbent on the customer to check and decide whether an EPCOS product with the properties described in the product specification is suitable for use in a particular customer application.
2. We also point out that **in individual cases, a malfunction of electronic components or failure before the end of their usual service life cannot be completely ruled out in the current state of the art, even if they are operated as specified**. In customer applications requiring a very high level of operational safety and especially in customer applications in which the malfunction or failure of an electronic component could endanger human life or health (e.g. in accident prevention or lifesaving systems), it must therefore be ensured by means of suitable design of the customer application or other action taken by the customer (e.g. installation of protective circuitry or redundancy) that no injury or damage is sustained by third parties in the event of malfunction or failure of an electronic component.
3. **The warnings, cautions and product-specific notes must be observed.**
4. In order to satisfy certain technical requirements, **some of the products described in this publication may contain substances subject to restrictions in certain jurisdictions (e.g. because they are classed as hazardous)**. Useful information on this will be found in our Material Data Sheets on the Internet ([www.epcos.com/material](http://www.epcos.com/material)). Should you have any more detailed questions, please contact our sales offices.
5. We constantly strive to improve our products. Consequently, **the products described in this publication may change from time to time**. The same is true of the corresponding product specifications. Please check therefore to what extent product descriptions and specifications contained in this publication are still applicable before or when you place an order. We also **reserve the right to discontinue production and delivery of products**. Consequently, we cannot guarantee that all products named in this publication will always be available. The aforementioned does not apply in the case of individual agreements deviating from the foregoing for customer-specific products.
6. Unless otherwise agreed in individual contracts, **all orders are subject to the current version of the "General Terms of Delivery for Products and Services in the Electrical Industry" published by the German Electrical and Electronics Industry Association (ZVEI)**.
7. The trade names EPCOS, BAOKE, Alu-X, CeraDiode, CSMP, CSSP, CTVS, DeltaCap, DigiSiMic, DSSP, FormFit, MiniBlue, MiniCell, MKK, MKD, MLSC, MotorCap, PCC, PhaseCap, PhaseCube, PhaseMod, PhiCap, SIFERRIT, SIFI, SIKOREL, SilverCap, SIMDAD, SiMic, SIMID, SineFormer, SIOV, SIP5D, SIP5K, ThermoFuse, WindCap are **trademarks registered or pending** in Europe and in other countries. Further information will be found on the Internet at [www.epcos.com/trademarks](http://www.epcos.com/trademarks).