

# Aluminum electrolytic capacitors

## Large-size capacitors

**Series/Type:** B41605  
**Date:** October 2015

© EPCOS AG 2015. Reproduction, publication and dissemination of this publication, enclosures hereto and the information contained therein without EPCOS' prior express consent is prohibited.

EPCOS AG is a TDK Group Company.

### Long-life grade capacitors

#### Applications

- High-reliability equipment in automotive power electronics
- Applications with highest ripple current load at high frequencies

#### Features

- High reliability and long useful life, up to 5000 h at 125 °C
- Very high ripple current capability optimized for high frequencies
- Compact design
- High vibration stability
- Storage for up to 15 years at a temperature of up to 35 °C.  
If the capacitor is stored for longer than two years, the operating voltage must be applied for one hour to ensure the specified leakage current.
- RoHS-compatible

#### Construction

- Charge/discharge-proof, polar
- Aluminum case, fully insulated
- Up to 40 g vibration stability version with middle corrugation
- Snap-in solder version with pins to hold component in place on PC-board
- Minus pole not insulated from case
- Overload protection (safety vent)
- Without insulation sleeve upon request

#### Terminals

- Version with wired terminals, weldable and solderable
- Snap-in with 3 terminals, protection against polarity reversal

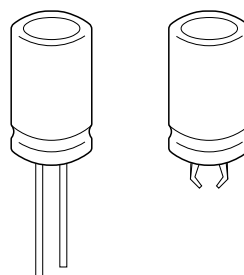
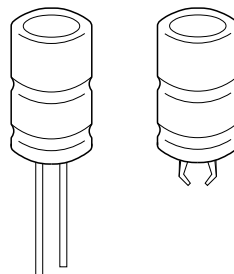

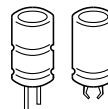

**Specifications and characteristics in brief**

Rated voltage $V_R$	25 ... 63 V DC	
Surge voltage $V_S$	$1.15 \cdot V_R$	
Rated capacitance $C_R$	2000 ... 27000 $\mu\text{F}$	
Capacitance tolerance	$\pm 20\% \triangleq M$	
Leakage current $I_{\text{leak}}$ (5 min, 20 °C)	$I_{\text{leak}} \leq 0.006 \mu\text{A} \cdot \left( \frac{C_R}{\mu\text{F}} \cdot \frac{V_R}{V} \right) + 4 \mu\text{A}$	
Self-inductance ESL	10 nH	
Useful life <sup>1)</sup>	Requirements:	
125 °C; $V_R$ ; $I_{\text{AC,R}}$	> 5000 h	$ \Delta C/C  \leq 30\%$ of initial value
85 °C; $V_R$ ; $2.3 \cdot I_{\text{AC,R}}$	> 20000 h	ESR $\leq 3$ times initial specified limit <sup>2)</sup>
40 °C; $V_R$ ; $2.0 \cdot I_{\text{AC,R}}$	> 500000 h	$I_{\text{leak}} \leq$ initial specified limit
Voltage endurance test	Post test requirements:	
125 °C; $V_R$	2000 h	$ \Delta C/C  \leq 10\%$ of initial value
		ESR $\leq 1.3$ times initial specified limit <sup>2)</sup>
		$I_{\text{leak}} \leq$ initial specified limit
Vibration resistance test	To IEC 60068-2-6, test Fc:	
	40 g vibration stability version with middle corrugation	Standard vibration version without middle corrugation
	Frequency range 10 Hz ... 2 kHz, displacement amplitude max. 3 mm, acceleration max. 40 g, duration $3 \times 2$ h. Capacitor mounted by its body which is rigidly clamped to the work surface.	Frequency range 10 Hz ... 2 kHz, displacement amplitude max. 0.75 mm, acceleration max. 10 g, duration $3 \times 2$ h. Capacitor mounted by its body which is rigidly clamped to the work surface.
IEC climatic category	To IEC 60068-1: 55/125/56 (–55 °C/+ 125 °C/56 days damp heat test)	
Detail specification	Similar to CECC 30301-809	
Sectional specification	IEC 60384-4	

1) Refer to chapter "General technical information, 5 Useful life" on how to interpret useful life.

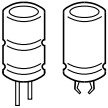
2)  $\text{ESR}_{\text{max}}$  at 100 Hz, 20 °C



**B41605**

**Compact – 125 °C**

**Dimensional drawings**

**Large-size capacitor, up to 40 g vibration stability version (with middle corrugation) with wired terminals**

\*) Permissible range of positions for minus pole marking

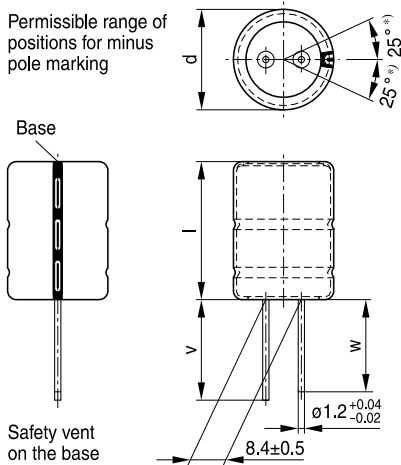

KAL1313-5-E

**Dimensions and weights**

Dimensions	Wire length	Approx.	Packing		
d +1	l ±2	v -2	w -2	weight	units
mm	mm	mm	mm	g	pcs.
22	40	25	23	21	56
25	40	25	23	28	56
25	50	25	23	35	56
30	50	15	13	50	36
35	50	15	13	68	30

**Large-size capacitor, standard vibration version with wired terminals**

\*) Permissible range of positions for minus pole marking

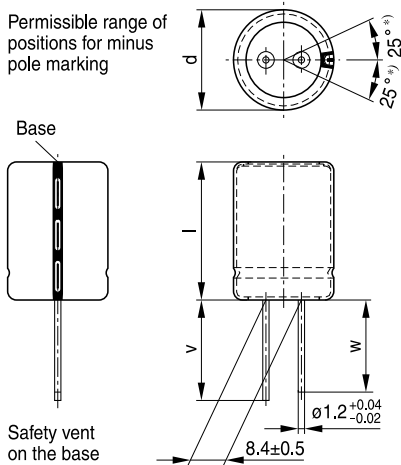

KAL1314-D-E

**Dimensions and weights**

Dimensions	Wire length	Approx.	Packing		
d +1	l ±2	v -2	w -2	weight	units
mm	mm	mm	mm	g	pcs.
22	40	25	23	21	56
25	40	25	23	28	56
25	50	25	23	35	56
30	50	15	13	50	36
35	50	15	13	68	30

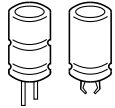
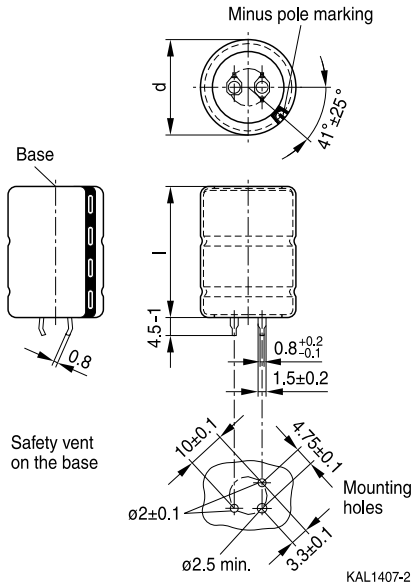
**Large-size capacitor, snap-in version high vibration stability (with middle corrugation)**

**Dimensions, weights and packing units**

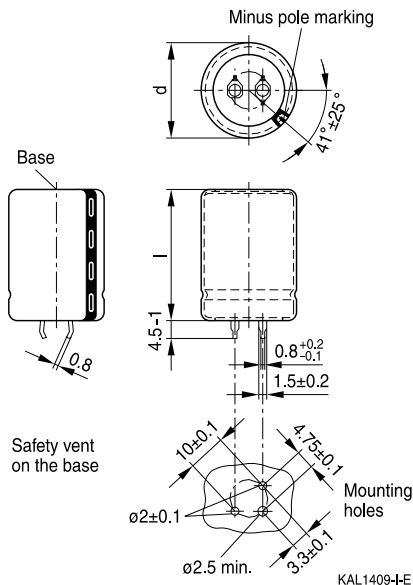
Dimensions		Approx. weight g	Packing units pcs.
d +1 mm	l ±2 mm		
22	40	21	160
25	40	28	130
25	50	35	130
30	50	50	80
35	50	68	60

**Large-size capacitor, snap-in version standard vibration stability**

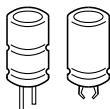
**Dimensions, weights and packing units**

Dimensions		Approx. weight g	Packing units pcs.
d +1 mm	l ±2 mm		
22	40	21	160
25	40	28	130
25	50	35	130
30	50	50	80
35	50	68	60



**B41605**

**Compact – 125 °C**

**Packing example of large-size capacitors, snap-in version**



For ecological reasons the packing is pure cardboard. Components can be withdrawn (in full or in part) in the correct position for insertion.

**Ordering codes for terminal styles and insulation features**

Identification in 3rd block of ordering code

Large-size capacitors

Terminal version	Insulation version	
	PET	
3 terminals 4.5 mm	M002	M003
Wired terminals	M008	M009

Ordering examples:

- B41605B5129M002 } large-size capacitor, snap-in version with 3 terminals and PET insulation
- B41605B5129M003 } large-size capacitor, snap-in version with 3 terminals, middle corrugation (high vibration stability up to 40 g) and PET insulation
- B41605B5129M008 } large-size capacitor, with wired terminals and PET insulation
- B41605B5129M009 } large-size capacitor, with wired terminals, middle corrugation (high vibration stability up to 40 g) and PET insulation

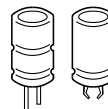
**Overview of available types**

$V_R$ (V DC)	25	40	55	63
	Case dimensions d × l (mm)			
$C_R$ (μF)				
2000				22 × 40
2500			22 × 40	
2700				25 × 40
3300			25 × 40	
3900		22 × 40		25 × 50
4700			25 × 50	
5100		25 × 40		
5600				30 × 50
6800	22 × 40	25 × 50	30 × 50	
8100				35 × 50
9000	25 × 40			
10000		30 × 50	35 × 50	
12000	25 × 50			
15000		35 × 50		
18000	30 × 50			
27000	35 × 50			

The capacitance and voltage ratings listed above are available in different cases upon request. Other voltage and capacitance ratings are also available upon request.

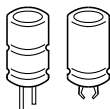
**B41605**
**Compact – 125 °C**
**Technical data and ordering codes**

$C_R$ 100 Hz 20 °C $\mu\text{F}$	Case dimensions $d \times l$ mm	$\text{ESR}_{\text{max}}$ 100 Hz 20 °C $\text{m}\Omega$	$\text{ESR}_{\text{max}}$ 100 Hz –40 °C $\text{m}\Omega$	$\text{ESR}_{\text{max}}$ 10 kHz 20 °C $\text{m}\Omega$	$I_{\text{AC,max}}$ 10 kHz 125 °C A	$I_{\text{AC,R}}$ 10 kHz 125 °C A	Ordering code (composition see below)
<b><math>V_R = 25 \text{ V DC}</math></b>							
6800	22 × 40	22	115	19	9.5	6.5	B41605C5688M00*
9000	25 × 40	18	80	15	10.5	7.1	B41605B5908M00*
12000	25 × 50	13	55	12	13.2	9.0	B41605B5129M00*
18000	30 × 50	11	45	11	14.3	9.8	B41605C5189M00*
27000	35 × 50	10	32	11	14.6	10.0	B41605C5279M00*
<b><math>V_R = 40 \text{ V DC}</math></b>							
3900	22 × 40	26	115	19	9.5	6.5	B41605B7398M00*
5100	25 × 40	21	80	15	10.5	7.1	B41605B7518M00*
6800	25 × 50	16	60	11	13.2	9.0	B41605B7688M00*
10000	30 × 50	13	45	11	14.4	9.9	B41605C7109M00*
15000	35 × 50	11	32	11	14.7	10.1	B41605C7159M00*
<b><math>V_R = 55 \text{ V DC}</math></b>							
2500	22 × 40	31	115	19	9.5	6.4	B41605B0258M00*
3300	25 × 40	24	80	15	10.5	7.1	B41605B0338M00*
4700	25 × 50	18	60	12	13.2	9.0	B41605B0478M00*
6800	30 × 50	15	45	11	14.3	9.8	B41605C0688M00*
10000	35 × 50	13	35	11	14.6	10.0	B41605C0109M00*
<b><math>V_R = 63 \text{ V DC}</math></b>							
2000	22 × 40	35	115	19	9.5	6.4	B41605B8208M00*
2700	25 × 40	26	85	15	10.4	7.0	B41605C8278M00*
3900	25 × 50	20	65	12	13.2	9.0	B41605B8398M00*
5600	30 × 50	16	45	11	14.3	9.8	B41605D8568M00*
8100	35 × 50	13	35	11	14.6	10.0	B41605C8818M00*

**Composition of ordering code**

\* = Terminal style

2 = for snap-in version with 3 terminals

3 = for snap-in version with 3 terminals and middle corrugation

8 = for version with wired terminals

9 = for version with wired terminals and middle corrugation



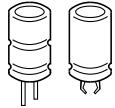

**B41605**

**Compact – 125 °C**

**Useful life<sup>1)</sup>**

depending on ambient temperature  $T_A$  under ripple current operating conditions at  $V_R$

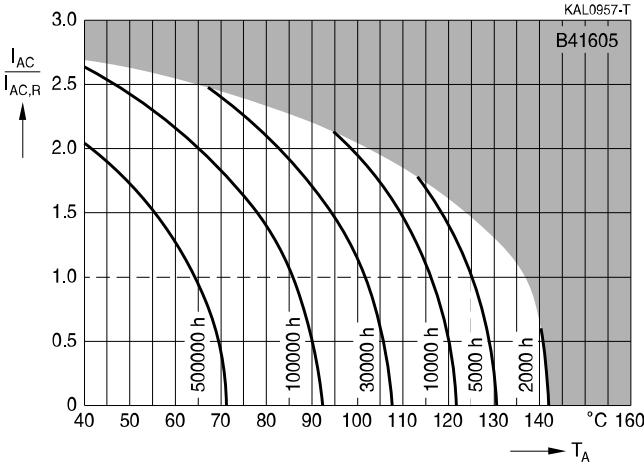

**Useful life<sup>1)</sup>**

depending on case temperature  $T_C$  under ripple current operating conditions at  $V_R$

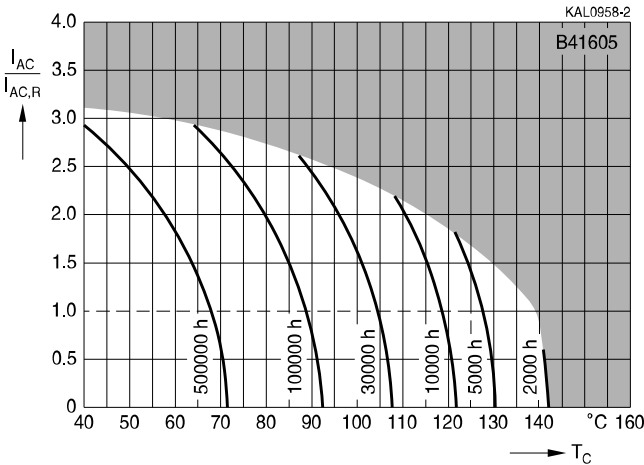

1) Refer to chapter "General technical information, 5 Useful life" on how to interpret useful life.

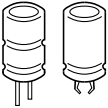

**B41605**

**Compact – 125 °C**

**Useful life<sup>1)</sup>**

depending on ambient temperature  $T_A$  under ripple current operating conditions at  $V_{op}$

$V_R = 25 \text{ V}; V_{op} \leq 20 \text{ V}$

$V_R = 55 \text{ V}; V_{op} \leq 48 \text{ V}$

$V_R = 40 \text{ V}; V_{op} \leq 35 \text{ V}$

$V_R = 63 \text{ V}; V_{op} \leq 55 \text{ V}$

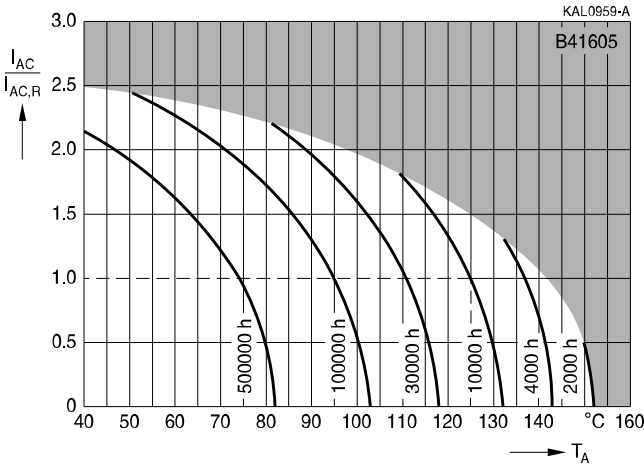

**Useful life<sup>1)</sup>**

depending on case temperature  $T_C$  under ripple current operating conditions at  $V_{op}$

$V_R = 25 \text{ V}; V_{op} \leq 20 \text{ V}$

$V_R = 55 \text{ V}; V_{op} \leq 48 \text{ V}$

$V_R = 40 \text{ V}; V_{op} \leq 35 \text{ V}$

$V_R = 63 \text{ V}; V_{op} \leq 55 \text{ V}$

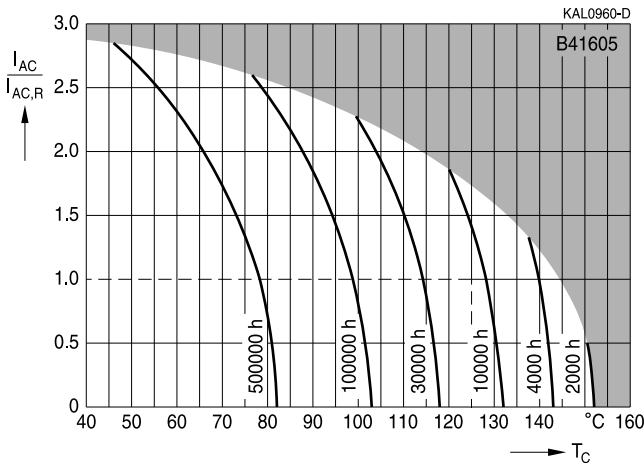

1) Refer to chapter "General technical information, 5 Useful life" on how to interpret useful life.

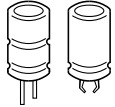

**Frequency factor of permissible ripple current  $I_{AC}$  versus frequency  $f$**

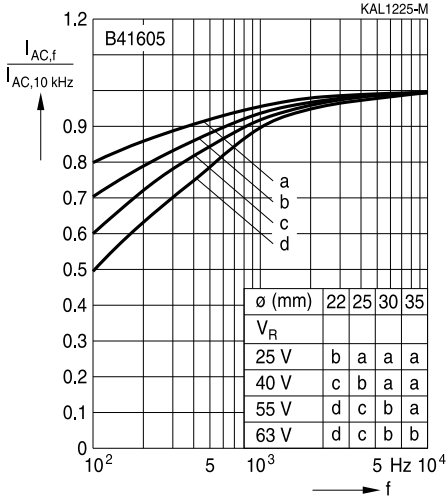

**Frequency characteristics of ESR**  
Typical behavior

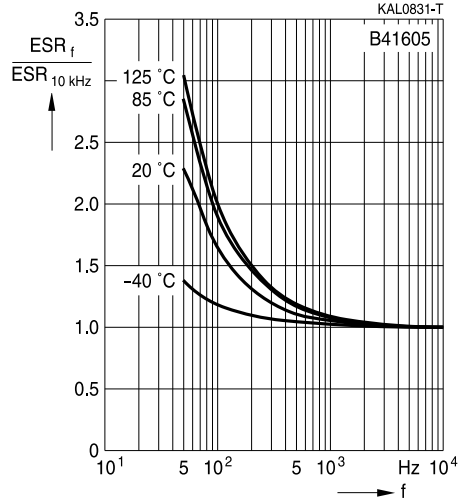

**Equivalent series resistance ESR versus frequency  $f$**

Typical behavior for 3300  $\mu$ F/55 V

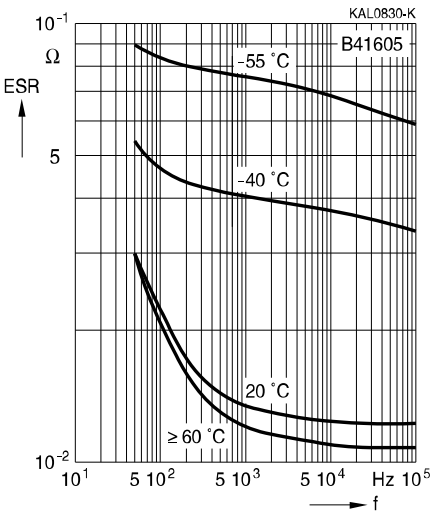

**Impedance  $Z$  versus frequency  $f$**

Typical behavior for 3300  $\mu$ F/55 V

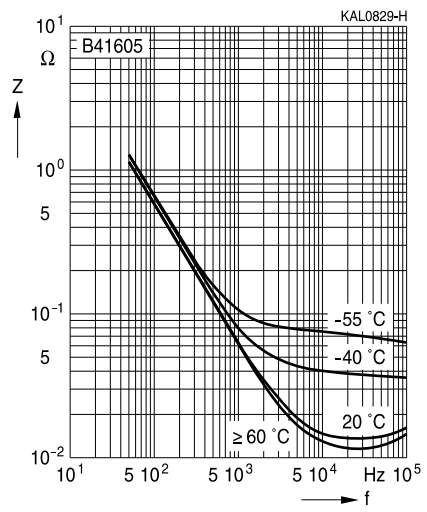

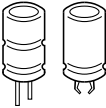

**B41605**

**Compact – 125 °C**

## Cautions and warnings

### Personal safety

The electrolytes used by EPCOS have been optimized both with a view to the intended application and with regard to health and environmental compatibility. They do not contain any solvents that are detrimental to health, e.g. dimethyl formamide (DMF) or dimethyl acetamide (DMAC).

Furthermore, some of the high-voltage electrolytes used by EPCOS are self-extinguishing.

As far as possible, EPCOS does not use any dangerous chemicals or compounds to produce operating electrolytes. However, in exceptional cases, such materials must be used in order to achieve specific physical and electrical properties because no alternative materials are currently known. However, the amount of dangerous materials used in our products is limited to an absolute minimum.

Materials and chemicals used in EPCOS aluminum electrolytic capacitors are continuously adapted in compliance with the EPCOS Corporate Environmental Policy and the latest EU regulations and guidelines such as RoHS, REACH/SVHC, GADSL, and ELV.

MDS (Material Data Sheets) are available on the EPCOS website for all types listed in the data book. MDS for customer specific capacitors are available upon request.

MSDS (Material Safety Data Sheets) are available for all of our electrolytes upon request.

Nevertheless, the following rules should be observed when handling aluminum electrolytic capacitors: No electrolyte should come into contact with eyes or skin. If electrolyte does come into contact with the skin, wash the affected areas immediately with running water. If the eyes are affected, rinse them for 10 minutes with plenty of water. If symptoms persist, seek medical treatment. Avoid inhaling electrolyte vapor or mists. Workplaces and other affected areas should be well ventilated. Clothing that has been contaminated by electrolyte must be changed and rinsed in water.

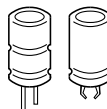

## Product safety

The table below summarizes the safety instructions that must be observed without fail. A detailed description can be found in the relevant sections of chapter "General technical information".

Topic	Safety information	Reference chapter "General technical information"
Polarity	Make sure that polar capacitors are connected with the right polarity.	1 "Basic construction of aluminum electrolytic capacitors"
Reverse voltage	Voltages of opposite polarity should be prevented by connecting a diode.	3.1.6 "Reverse voltage"
Mounting position of screw-terminal capacitors	Screw terminal capacitors must not be mounted with terminals facing down unless otherwise specified.	11.1. "Mounting positions of capacitors with screw terminals"
Robustness of terminals	The following maximum tightening torques must not be exceeded when connecting screw terminals: M5: 2.5 Nm M6: 4.0 Nm	11.3 "Mounting torques"
Mounting of single-ended capacitors	The internal structure of single-ended capacitors might be damaged if excessive force is applied to the lead wires. Avoid any compressive, tensile or flexural stress. Do not move the capacitor after soldering to PC board. Do not pick up the PC board by the soldered capacitor. Do not insert the capacitor on the PC board with a hole space different to the lead space specified.	11.4 "Mounting considerations for single-ended capacitors"
Soldering	Do not exceed the specified time or temperature limits during soldering.	11.5 "Soldering"
Soldering, cleaning agents	Do not allow halogenated hydrocarbons to come into contact with aluminum electrolytic capacitors.	11.6 "Cleaning agents"
Upper category temperature	Do not exceed the upper category temperature.	7.2 "Maximum permissible operating temperature"
Passive flammability	Avoid external energy, e.g. fire.	8.1 "Passive flammability"

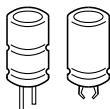

**B41605**

**Compact – 125 °C**

Topic	Safety information	Reference chapter "General technical information"
Active flammability	Avoid overload of the capacitors.	8.2 "Active flammability"
Maintenance	Make periodic inspections of the capacitors. Before the inspection, make sure that the power supply is turned off and carefully discharge the electricity of the capacitors. Do not apply excessive mechanical stress to the capacitor terminals when mounting.	10 "Maintenance"
Storage	Do not store capacitors at high temperatures or high humidity. Capacitors should be stored at +5 to +35 °C and a relative humidity of ≤ 75%.	7.3 "Shelf life and storage conditions"
		Reference chapter "Capacitors with screw terminals"
Breakdown strength of insulating sleeves	Do not damage the insulating sleeve, especially when ring clips are used for mounting.	"Screw terminals – accessories"

### Display of ordering codes for EPCOS products

The ordering code for one and the same product can be represented differently in data sheets, data books, other publications and the website of EPCOS, or in order-related documents such as shipping notes, order confirmations and product labels. The varying representations of the ordering codes are due to different processes employed and do not affect the specifications of the respective products. Detailed information can be found on the Internet under [www.epcos.com/orderingcodes](http://www.epcos.com/orderingcodes).

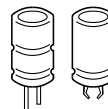
**Symbols and terms**

Symbol	English	German
C	Capacitance	Kapazität
$C_R$	Rated capacitance	Nennkapazität
$C_S$	Series capacitance	Serienkapazität
$C_{S,T}$	Series capacitance at temperature T	Serienkapazität bei Temperatur T
$C_f$	Capacitance at frequency f	Kapazität bei Frequenz f
d	Case diameter, nominal dimension	Gehäusedurchmesser, Nennmaß
$d_{max}$	Maximum case diameter	Maximaler Gehäusedurchmesser
ESL	Self-inductance	Eigeninduktivität
ESR	Equivalent series resistance	Ersatzserienwiderstand
$ESR_f$	Equivalent series resistance at frequency f	Ersatzserienwiderstand bei Frequenz f
$ESR_T$	Equivalent series resistance at temperature T	Ersatzserienwiderstand bei Temperatur T
f	Frequency	Frequenz
I	Current	Strom
$I_{AC}$	Alternating current (ripple current)	Wechselstrom
$I_{AC,RMS}$	Root-mean-square value of alternating current	Wechselstrom, Effektivwert
$I_{AC,f}$	Ripple current at frequency f	Wechselstrom bei Frequenz f
$I_{AC,max}$	Maximum permissible ripple current	Maximal zulässiger Wechselstrom
$I_{AC,R}$	Rated ripple current	Nennwechselstrom
$I_{leak}$	Leakage current	Reststrom
$I_{leak,op}$	Operating leakage current	Betriebsreststrom
l	Case length, nominal dimension	Gehäuselänge, Nennmaß
$l_{max}$	Maximum case length (without terminals and mounting stud)	Maximale Gehäuselänge (ohne Anschlüsse und Gewindebolzen)
R	Resistance	Widerstand
$R_{ins}$	Insulation resistance	Isolationswiderstand
$R_{symm}$	Balancing resistance	Symmetrierwiderstand
T	Temperature	Temperatur
$\Delta T$	Temperature difference	Temperaturdifferenz
$T_A$	Ambient temperature	Umgebungstemperatur
$T_C$	Case temperature	Gehäusetemperatur
$T_B$	Capacitor base temperature	Temperatur des Gehäusebodens
t	Time	Zeit
$\Delta t$	Period	Zeitraum
$t_b$	Service life (operating hours)	Brauchbarkeitsdauer (Betriebszeit)

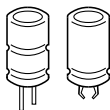

**B41605**

**Compact – 125 °C**

Symbol	English	German
V	Voltage	Spannung
V <sub>F</sub>	Forming voltage	Formierspannung
V <sub>op</sub>	Operating voltage	Betriebsspannung
V <sub>R</sub>	Rated voltage, DC voltage	Nennspannung, Gleichspannung
V <sub>S</sub>	Surge voltage	Spitzenspannung
X <sub>C</sub>	Capacitive reactance	Kapazitiver Blindwiderstand
X <sub>L</sub>	Inductive reactance	Induktiver Blindwiderstand
Z	Impedance	Scheinwiderstand
Z <sub>T</sub>	Impedance at temperature T	Scheinwiderstand bei Temperatur T
tan δ	Dissipation factor	Verlustfaktor
λ	Failure rate	Ausfallrate
ε <sub>0</sub>	Absolute permittivity	Elektrische Feldkonstante
ε <sub>r</sub>	Relative permittivity	Dielektrizitätszahl
ω	Angular velocity; $2 \cdot \pi \cdot f$	Kreisfrequenz; $2 \cdot \pi \cdot f$

**Note**

All dimensions are given in mm.



## Important notes

The following applies to all products named in this publication:

1. Some parts of this publication contain **statements about the suitability of our products for certain areas of application**. These statements are based on our knowledge of typical requirements that are often placed on our products in the areas of application concerned. We nevertheless expressly point out **that such statements cannot be regarded as binding statements about the suitability of our products for a particular customer application**. As a rule, EPCOS is either unfamiliar with individual customer applications or less familiar with them than the customers themselves. For these reasons, it is always ultimately incumbent on the customer to check and decide whether an EPCOS product with the properties described in the product specification is suitable for use in a particular customer application.
2. We also point out that **in individual cases, a malfunction of electronic components or failure before the end of their usual service life cannot be completely ruled out in the current state of the art, even if they are operated as specified**. In customer applications requiring a very high level of operational safety and especially in customer applications in which the malfunction or failure of an electronic component could endanger human life or health (e.g. in accident prevention or lifesaving systems), it must therefore be ensured by means of suitable design of the customer application or other action taken by the customer (e.g. installation of protective circuitry or redundancy) that no injury or damage is sustained by third parties in the event of malfunction or failure of an electronic component.
3. **The warnings, cautions and product-specific notes must be observed**.
4. In order to satisfy certain technical requirements, **some of the products described in this publication may contain substances subject to restrictions in certain jurisdictions (e.g. because they are classed as hazardous)**. Useful information on this will be found in our Material Data Sheets on the Internet ([www.epcos.com/material](http://www.epcos.com/material)). Should you have any more detailed questions, please contact our sales offices.
5. We constantly strive to improve our products. Consequently, **the products described in this publication may change from time to time**. The same is true of the corresponding product specifications. Please check therefore to what extent product descriptions and specifications contained in this publication are still applicable before or when you place an order. We also **reserve the right to discontinue production and delivery of products**. Consequently, we cannot guarantee that all products named in this publication will always be available. The aforementioned does not apply in the case of individual agreements deviating from the foregoing for customer-specific products.
6. Unless otherwise agreed in individual contracts, **all orders are subject to the current version of the "General Terms of Delivery for Products and Services in the Electrical Industry" published by the German Electrical and Electronics Industry Association (ZVEI)**.

## Important notes

7. The trade names EPCOS, Alu-X, CeraDiode, CeraLink, CeraPad, CeraPlas, CSMP, CSSP, CTVS, DeltaCap, DigiSiMic, DSSP, ExoCore, FilterCap, FormFit, LeaXield, MiniBlue, MiniCell, MKD, MKK, MotorCap, PCC, PhaseCap, PhaseCube, PhaseMod, PhiCap, PQSine, SIFERRIT, SIFI, SIKOREL, SilverCap, SIMDAD, SiMic, SIMID, SineFormer, SIOV, SIP5D, SIP5K, TFAP, ThermoFuse, WindCap are **trademarks registered or pending** in Europe and in other countries. Further information will be found on the Internet at [www.epcos.com/trademarks](http://www.epcos.com/trademarks).