



Film Capacitors

Power Electronic Capacitors

Series/Type: MKP DC
Ordering code: B2562*
Date: January 2016
Version: 11

© EPCOS AG 2016. Reproduction, publication and dissemination of this publication, enclosures hereto and the information contained therein without EPCOS' prior express consent is prohibited.

EPCOS AG is a TDK Group Company.

Construction

1. General data

Characteristics	
Standard capacitance tolerance	K: $\pm 10\%$
Dielectric dissipation factor ($\tan \delta_o$)	$2 \cdot 10^{-4}$
Service life expectancy (refer to section 2)	100 000 h at $\Theta_{hs} +75^\circ\text{C}$ und V_{RDC} up to 200 000 h (depending on real operating conditions)
Fit rate	50 at V_{RDC} and 70°C (refer to section 4)
Minimum temperature $\Theta_{min.}$	-55°C
Maximum temperature $\Theta_{max.}$	$+85^\circ\text{C}$ for diameter 85 and 90 mm $+75^\circ\text{C}$ for diameter 116 mm
Storage temperature Θ_{stg}	$-55 \dots +85^\circ\text{C}$
Maximum hotspot temperature Θ_{hs} (refer to section 1)	$+85^\circ\text{C}$ for diameter 85 and 90 mm $+75^\circ\text{C}$ for diameter 116 mm
Climatic category	55/85/56 for 85 and 90 mm diameter 55/75/56 for 116 mm diameter
Maximum altitude	2000 m above sea level (derating curves available upon request)

Test data	
Voltage between terminals U_{TT}	1.5 V DC, 10 s
Voltage between terminals and case U_{TC}	4000 V AC, 10 s
Life test	According to IEC 61071
Cooling	Naturally air-cooled (or forced air cooling)
Degree of protection	Indoor mounting

Design data	
Impregnation	Resin filling: Non PCB, hard polyurethane (dry type)
Mounting and grounding	M12 threaded bolt on bottom of the aluminum case
Max. torque (case) M12 stud	10 Nm
Max. torque terminal	Female M6: 5 Nm Female M8: 6 Nm Male M8: 8 Nm

Reference standards	
IEC 61071	
RoHS compliance	
Certification: UL 810-5th edition (refer to table 1.3)	

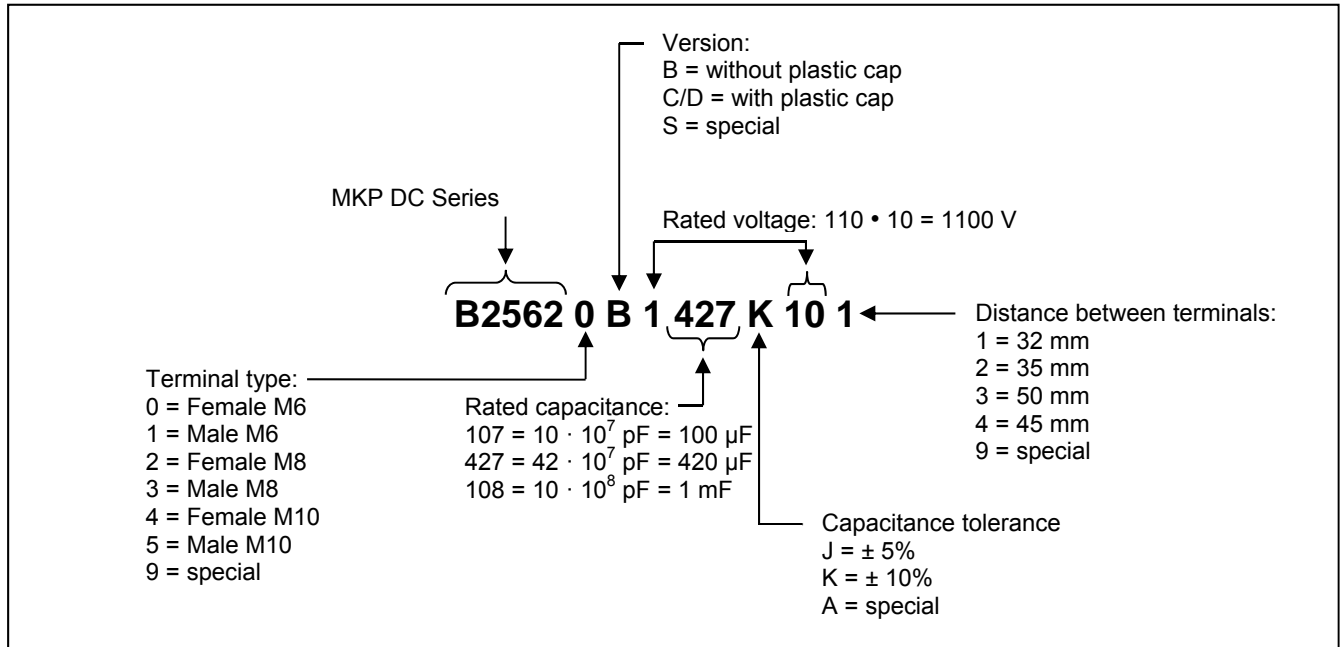
1.1 Structure of ordering code

1.2 Standard types

Diameter (Ø) Terminal type		D (mm) OC ending	32 ± 0.5 - **1	45 ± 0.5 - **4	50 ± 0.5 - **3
85 mm	Female M6 (B25620)		standard		
	Male M8 (B25623)			standard	
90 mm	Female M6 (B25620)			available	
	Female M6 (B25620)				standard

Other terminal configurations available upon request.

1.3 UL approved types

Diameter (Ø)	Series
85 mm	B2562xC B2562xD
90 mm	all types
116 mm	all types

1.4 Drawings types

Figure 1: - B25620B - Ø 85 mm
 - Female terminals (M6)
 - Between terminals 32±0.5 mm

Figure 2: - B25620C / B25620D - Ø 85 mm
 - Female terminals (M6)
 - Between terminals 32±0.5 mm

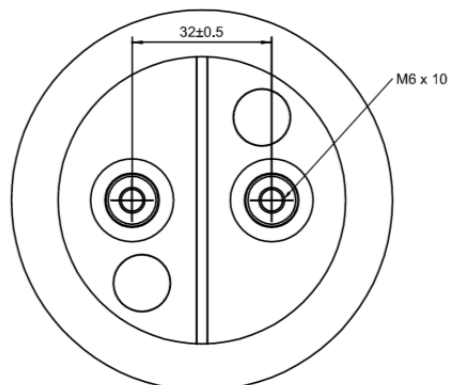
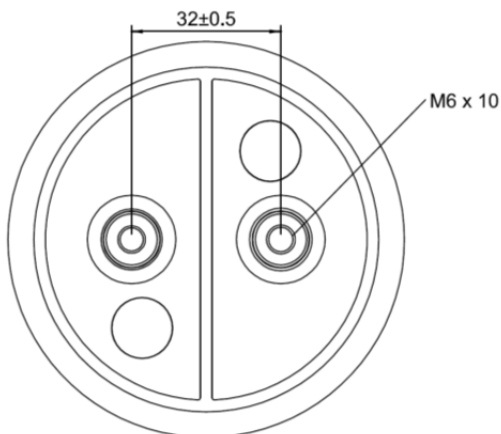
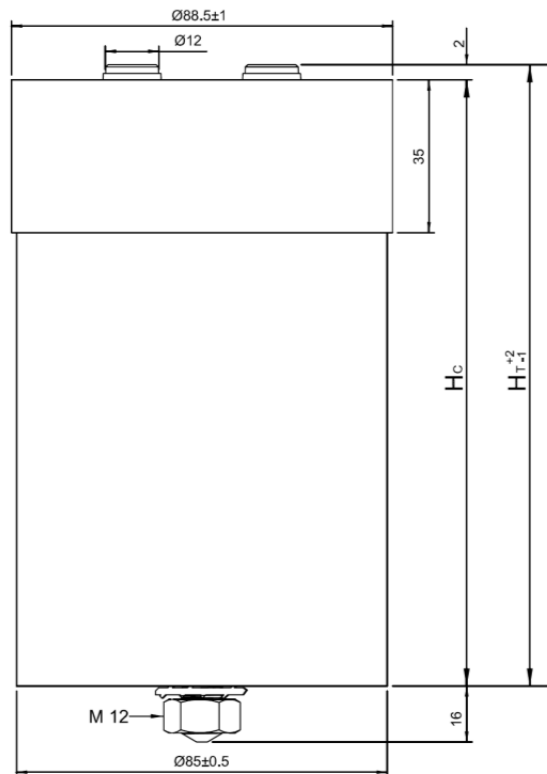
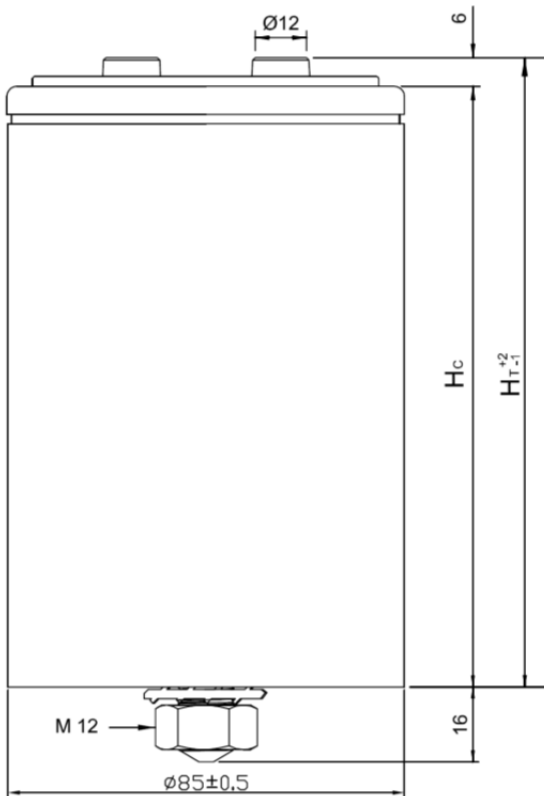

Figure 3: - B25623B - Ø 90 mm
 - Male terminals (M8)
 - Between terminals 45±0.5 mm

Figure 4: - B25620B - Ø 116 mm
 - Female terminals (M6)
 - Between terminals 50±0.5 mm

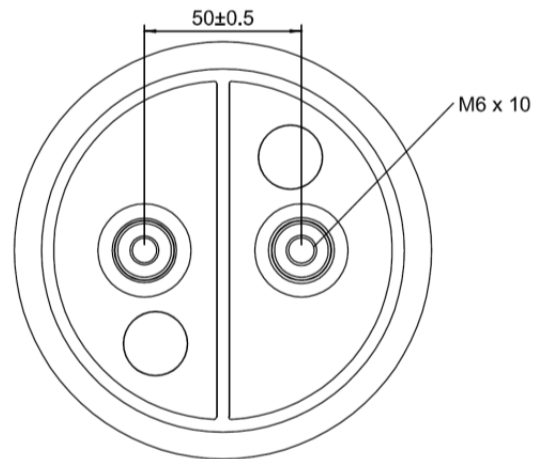
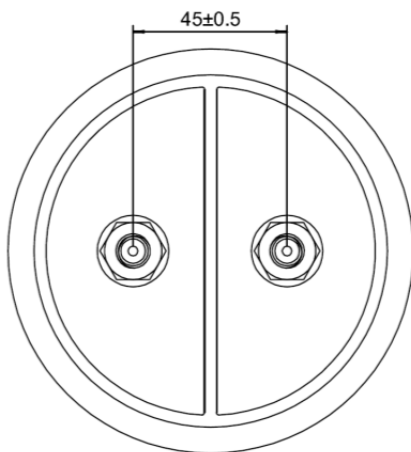
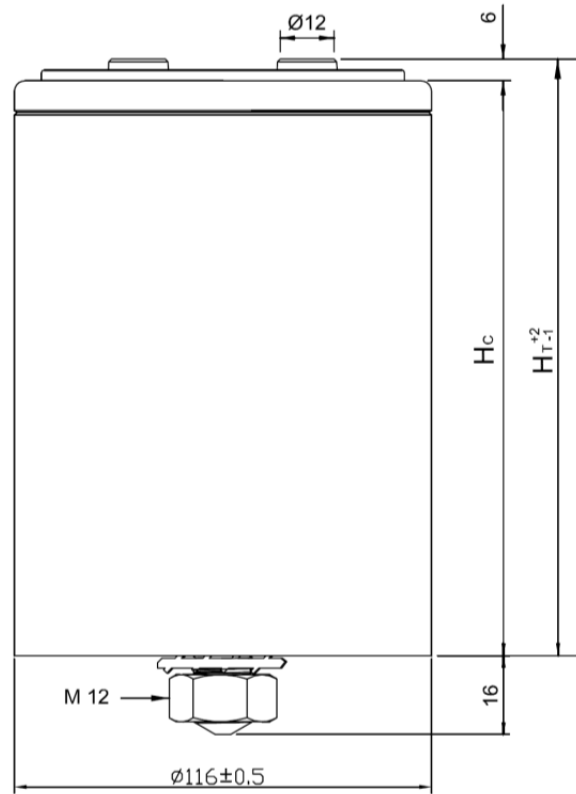
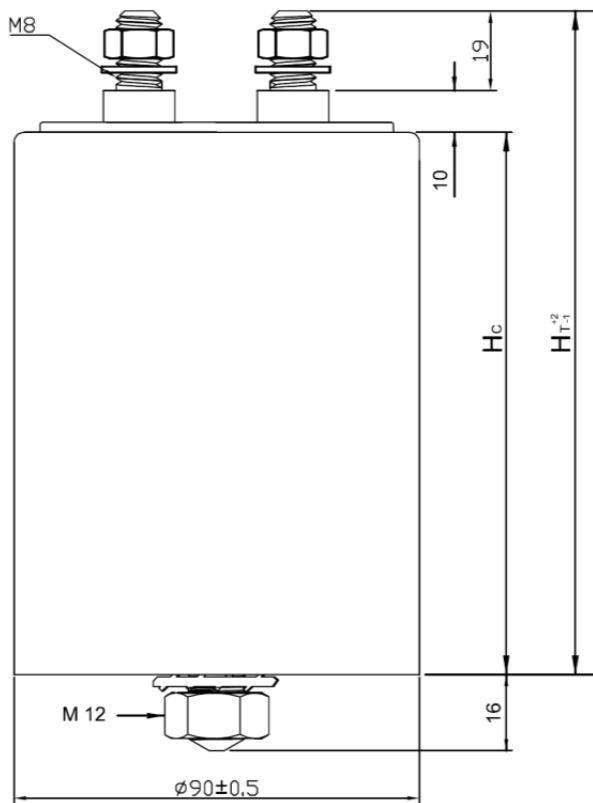
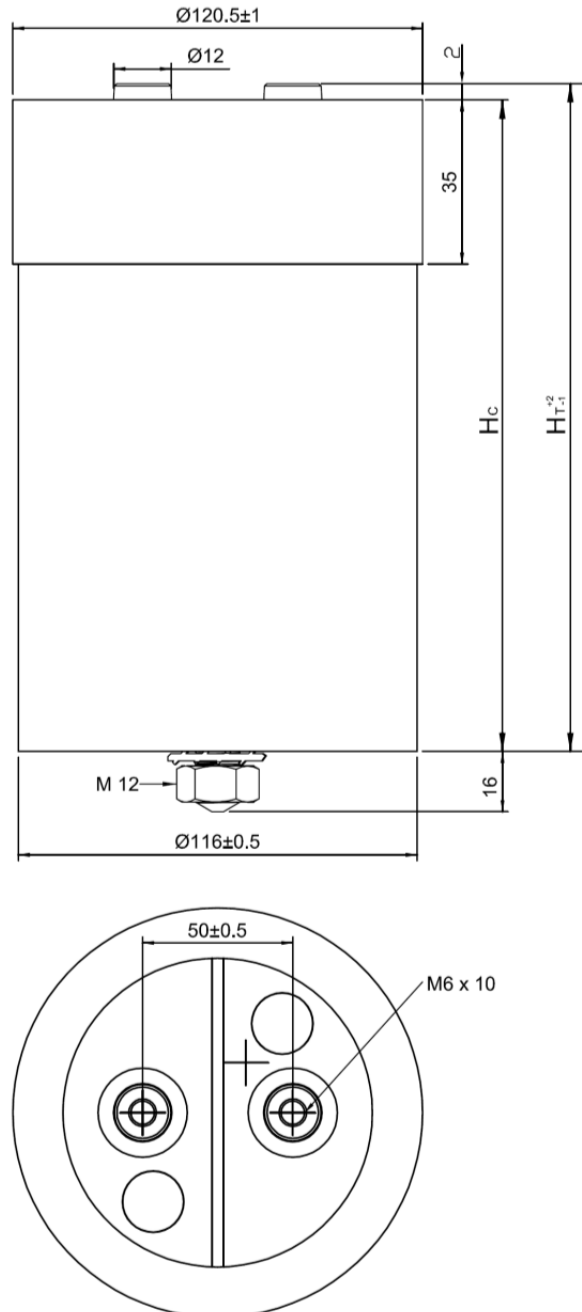

Figure 5: - B25620C / B25620D - Ø 116 mm
 - Female terminals (M6)
 - Between terminals 50±0.5 mm



M12 stud on bottom of the aluminum case, nut and washer for fixing are standard for all types.

Terms and characteristics

The following definitions apply to power capacitors according to IEC 61071.

Rated capacitance C_R

Nominal value of the capacitance at 20 °C and measuring frequency range of 50 to 120 Hz.

Rated DC voltage $V_{R\ DC}$

Maximum operating peak voltage of either polarity but of a non-reversing type wave form, for which the capacitor has been designed, for continuous operation.

Ripple voltage V_r

Peak-to-peak alternating component of the unidirectional voltage.

This value must not exceed $0.28 \cdot V_{R\ DC}$

Maximum surge voltage V_s

Peak voltage induced by a switching or any other disturbance of the system which is allowed for a limited number of times and duration.

- Maximum duration: 50 ms / pulse

- Maximum number of occurrences: 1000 (during load)

Insulation voltage V_i

Rms rated value of the insulation voltage of capacitive elements and terminals to case or earth. When it is not specified in the product data sheet, the insulation voltage is at least:

$$V_i = \frac{V_R}{\sqrt{2}}$$

Maximum rate of voltage rise $(dV/dt)_{\max}$

Maximum permissible repetitive rate of voltage rise of the operational voltage.

Maximum current I_{\max}

Maximum rms current for continuous operation.

Maximum peak current \hat{I}

Maximum permissible repetitive current amplitude during continuous operation.

Maximum peak current (\hat{I}) and maximum rate of voltage rise $(dV/dt)_{\max}$ on a capacitor are related as follows:

$$\hat{I} = C \cdot (dV/dt)_{\max}$$

Maximum surge current \hat{I}_s

Admissible peak current induced by a switching or any other disturbance of the system which is allowed for a limited number of times (1000 times) and duration (50 ms / pulse).

$$\hat{I}_s = C \cdot (dV/dt)_s$$

Ambient temperature Θ_A

Temperature of the surrounding air, measured at 10 cm distance and 2/3 of the case height of the capacitor.

Lowest operating temperature Θ_{\min}

Lowest permitted ambient temperature which a capacitor may be energized.

Maximum operating temperature Θ_{max}

Highest permitted capacitor temperature during operation, i.e. temperature at the hottest point of the case.

Hot-spot temperature Θ_{hs}

Temperature zone inside of the capacitor at hottest spot.

$$\Theta_{hs} = T_{amb} + I_{rms}^2 \cdot ESR \cdot R_{th}$$

Tangent of the loss angle of a capacitor $\tan \delta$

Ratio between the equivalent series resistance and the capacitive reactance of a capacitor at a specified sinusoidal alternating voltage, frequency and temperature.

Series resistance R_s

The sum of all Ohmic resistances occurring inside the capacitor.

ESR

ESR (Equivalent Series Resistance) representing entire active power in capacitor.

$$ESR = \frac{\tan \delta}{\omega \cdot C} = R_s + \frac{\tan \delta_0}{\omega \cdot C}$$

Thermal resistance R_{th}

The thermal resistance indicates by how many degrees the capacitor temperature at the hot spot rises in relation to the dissipation losses.

Maximum power loss P_{max}

Maximum permissible power dissipation for the capacitor's operation.

$$P_{max} = \frac{\Theta_{hs} - \Theta_A}{R_{th}}$$

Self inductance L_{self}

The sum of all inductive elements which are contained in a capacitor.

Resonance frequency f_r

The lowest frequency at which the impedance of the capacitor becomes minimum.

$$f_r = \frac{1}{2\pi \cdot \sqrt{L_{self} \cdot C_R}}$$

$V_{RDC} = 700 \text{ V DC} / V_{TT} = 1050 \text{ V DC}, 10 \text{ s} / V_{TC} = 4000 \text{ V AC}, 10 \text{ s}$

C_R μF	I_{MAX}^1 A	I_s kA	\hat{I} kA	ESR ² m Ω	L_{self} nH	R_{TH} K/W	D mm	H _c mm	H _r mm	Weight kg	Fig.	Ordering code
280	55	12.1	4.0	1.2	≤ 40	4.0	85	70	76	0.45	1	B25620B0287K701
500	60	13.5	4.5	1.3	≤ 40	3.0	90	95	124	0.73	3	B25623B0507K704
560	80	24.2	8.0	1.1	≤ 40	2.9	116	70	76	0.88	4	B25620B0567K703
620	55	12.1	4.0	1.9	≤ 40	2.9	85	120	126	0.71	1	B25620B0627K701
700	55	12.1	4.0	2.0	≤ 40	2.8	85	132	138	0.87	1	B25620B0707K701
780	65	13.4	4.5	1.9	≤ 40	2.5	90	132	161	1.00	3	B25623B0787K704
900	80	24.3	8.0	1.2	≤ 40	2.3	116	95	101	1.13	4	B25620B0907K703
1240	80	24.3	8.1	1.3	≤ 40	2.2	116	120	126	1.40	4	B25620B0128K743
1400	80	24.1	8.0	1.6	≤ 40	2.1	116	132	138	1.55	4	B25620B0148K703

 $V_{RDC} = 900 \text{ V DC} / V_{TT} = 1350 \text{ V DC}, 10 \text{ s} / V_{TC} = 4000 \text{ V AC}, 10 \text{ s}$

C_R μF	I_{MAX}^1 A	I_s kA	\hat{I} kA	ESR ² m Ω	L_{self} nH	R_{TH} K/W	D mm	H _c mm	H _r mm	Weight kg	Fig.	Ordering code
220	50	10.8	3.6	1.3	≤ 40	4.0	85	70	76	0.45	1	B25620B0227K881
220	50	10.8	3.6	1.3	≤ 40	4.0	85	74	76	0.48	2	B25620C0227K881
350	50	10.7	3.6	1.5	≤ 40	3.3	85	95	101	0.58	1	B25620B0357K881
350	50	10.7	3.6	1.5	≤ 40	3.3	85	99	101	0.61	2	B25620C0357K881
420	60	11.9	4.0	1.4	≤ 40	3.0	90	95	124	0.73	3	B25623B0427K904
440	65	21.7	7.2	0.8	≤ 40	2.9	116	70	76	0.88	4	B25620B0447K883
480	55	10.8	3.6	2.0	≤ 40	2.9	85	120	126	0.71	1	B25620B0487K881
480	55	10.8	3.6	2.0	≤ 40	2.9	85	124	126	0.74	2	B25620C0487K881
550	50	11	3.7	2.8	≤ 40	2.8	85	132	138	0.87	1	B25620B0557K881
550	50	11	3.7	2.8	≤ 40	2.8	85	136	138	0.9	2	B25620C0557K881
580	62	11.9	4.0	1.8	≤ 40	2.8	90	120	149	0.9	3	B25623B0587K904
650	62	11.8	3.9	2.0	≤ 40	2.5	90	132	161	1	3	B25623B0657K904
700	70	21.5	7.1	1.3	≤ 40	2.3	116	95	101	1.13	4	B25620B0707K883
730	62	11.8	3.9	2.8	≤ 60	2.3	90	145	174	1.2	3	B25623B0737K904
750	75	23.1	7.7	1.1	≤ 60	2.1	85	173	179	1.1	1	B25620B0757K881
750	75	23.1	7.7	1.1	≤ 60	2.1	85	177	179	1.13	2	B25620C0757K881
830	75	23.5	7.8	1.5	≤ 60	2.0	90	173	202	1.3	3	B25623B0837K904
970	75	21.7	7.2	1.9	≤ 40	2.2	116	120	126	1.4	4	B25620B0977K883
1100	80	21.7	7.2	1.4	≤ 40	2.1	116	132	138	1.55	4	B25620B0118K883
1500	100	43	15.4	1.1	≤ 60	2.0	116	173	179	1.945	4	B25620B0158K883
1500	100	43	15.4	1.1	≤ 60	2.0	116	177	179	1.945	5	B25620C0158K883

¹ I_{MAX} at $\ominus 40 \text{ }^\circ\text{C}$, refer to "current derating" section for more details

² ESR at 1 kHz (typical value)

Other configurations and capacitance tolerances available upon request

$V_{RDC} = 1100 \text{ V DC} / V_{TT} = 1650 \text{ V DC}, 10 \text{ s} / V_{TC} = 4000 \text{ V AC}, 10 \text{ s}$

C_R μF	I_{MAX}^1 A	I_s kA	I kA	ESR ² m Ω	L_{self} nH	R_{TH} K/W	D mm	H _c mm	H _T mm	Weight kg	Fig.	Ordering code
140	50	8.6	2.9	1.4	≤ 40	4.0	85	70	76	0.45	1	B25620B1147K101
140	50	8.6	2.9	1.4	≤ 40	4.0	85	74	76	0.48	2	B25620C1147K101
220	55	9.5	3.2	1.6	≤ 40	3.3	90	83	112	0.53	3	B25623B1227K104
270	55	9.6	3.2	1.8	≤ 40	3.0	90	95	124	0.73	3	B25623B1277K104
280	75	17.2	5.7	1.2	≤ 40	2.9	116	70	76	0.9	4	B25620B1287K103
310	50	8.6	2.9	2.3	≤ 40	2.9	85	120	126	0.71	1	B25620B1317K101
310	50	8.6	2.9	2.3	≤ 40	2.9	85	124	126	0.73	2	B25620C1317K101
370	60	9.5	3.2	2.1	≤ 40	2.8	90	120	149	0.9	3	B25623B1377K104
400	75	17.3	5.8	1.5	≤ 40	2.4	85	152	154	1	2	B25620D1407K101
420	63	8.8	2.9	2.4	≤ 40	2.8	85	135	141	0.87	1	B25620B1427A101*
420	63	8.8	2.9	2.4	≤ 40	2.8	85	139	141	0.9	2	B25620C1427A101*
420	75	17.3	5.8	1.5	≤ 40	2.4	85	155	161	1	1	B25620B1427K101
420	75	17.3	5.8	1.5	≤ 40	2.4	85	159	161	1	2	B25620C1427K101
420	60	9.5	3.2	2.4	≤ 40	2.5	90	132	161	1	3	B25623B1427K104
450	75	16.5	5.4	2.0	≤ 40	2.3	116	95	101	1.13	4	B25620B1457K103
450	80	17.3	5.8	1.1	≤ 60	2.1	85	177	179	1.05	2	B25620D1457K101
470	60	9.5	3.2	2.6	≤ 60	2.3	90	145	174	1.2	3	B25623B1477K104
480	80	17.3	5.8	1.8	≤ 60	2.1	85	173	179	1.05	1	B25620B1487K101
480	80	17.3	5.8	1.8	≤ 60	2.1	85	177	179	1.08	2	B25620C1487K101
530	80	18.8	6.3	1.0	≤ 60	2.0	90	173	202	1.3	3	B25623B1537K104
610	80	16.8	5.6	1.7	≤ 40	2.2	116	120	126	1.4	4	B25620B1617K103
610	80	17	5.7	1.2	≤ 60	1.9	85	227	229	2.2	2	B25620D1617K101
700	80	16.8	5.6	1.8	≤ 40	2.1	116	132	138	1.55	4	B25620B1707K103
700	100	27	8.9	0.9	≤ 60	2.0	116	177	179	2.05	5	B25620D1707K103
940	100	32.7	11.0	1.2	≤ 60	2.0	116	173	179	2.06	4	B25620B1947K103
1100	100	30.8	10.3	1.5	≤ 100	1.8	116	223	229	2.56	4	B25620B1118K103
1500	100	32.5	10.8	1.3	≤ 90	1.5	116	273	279	2.8	4	B25620B1158K103

* Capacitance tolerance A: -15% ... 0%

¹ I_{MAX} at $\Theta 40 \text{ }^\circ\text{C}$, refer to "current derating" section for more details

² ESR at 1 kHz (typical value)

Other configurations and capacitance tolerances available upon request

$V_{RDC} = 1200 \text{ V DC} / V_{TT} = 1800 \text{ V DC}, 10 \text{ s} / V_{TC} = 4000 \text{ V AC}, 10 \text{ s}$

C_R μF	I_{MAX}^1 A	I_s kA	\hat{I} kA	ESR ² m Ω	L_{self} nH	R_{TH} K/W	D mm	H _c mm	H _T mm	Weight kg	Fig.	Ordering code
220	50	8.6	2.9	3.1	≤ 40	3.0	90	95	124	0.73	3	B25623B1227K204
300	50	8.5	2.8	2.9	≤ 40	2.8	90	120	149	0.9	3	B25623B1307K204
340	50	8.5	2.8	3.0	≤ 40	2.5	90	132	161	1	3	B25623B1347K204
360	70	15.2	5.07	1.8	≤ 40	2.3	116	95	101	1.13	4	B25620B1367K203
440	75	17.1	5.7	1.6	≤ 60	2.0	90	173	202	1.3	3	B25623B1447K204
500	75	15.3	5.12	2.2	≤ 40	2.2	116	120	126	1.4	4	B25620B1507K203
550	80	16.9	5.63	1.5	≤ 90	1.8	90	223	252	1.4	3	B25623B1557K204
570	75	15.4	5.14	2.2	≤ 40	2.1	116	133	139	1.55	4	B25620B1577K203
730	100	30.8	10.2	1.4	≤ 60	2.0	116	173	179	2.05	4	B25620B1737K203
1000	100	30.7	10.2	1.4	≤ 90	1.8	116	223	229	2.56	4	B25620B1108K203

 $V_{RDC} = 1320 \text{ V DC} / V_{TT} = 1980 \text{ V DC}, 10 \text{ s} / V_{TC} = 4000 \text{ V AC}, 10 \text{ s}$

C_R μF	I_{MAX}^1 A	I_s kA	\hat{I} kA	ESR ² m Ω	L_{self} nH	R_{TH} K/W	D mm	H _c mm	H _T mm	Weight kg	Fig.	Ordering code
160	48	6.8	2.3	2.8	≤ 40	3.3	85	95	101	0.58	1	B25620B1167K321
190	51	8.1	2.7	2.6	≤ 40	3.0	90	95	124	0.73	3	B25623B1197K304
220	45	7.4	2.5	3.4	≤ 40	2.9	85	120	126	0.71	1	B25620B1227K321
220	45	7.4	2.5	3.4	≤ 40	2.9	85	124	126	0.73	2	B25620C1227K321
250	51	7.7	2.6	3.2	≤ 40	2.8	90	120	149	0.9	3	B25623B1257K304
260	45	7.6	2.6	3.6	≤ 40	2.8	85	132	138	0.87	1	B25620B1267K321
260	45	7.6	2.6	3.6	≤ 40	2.8	85	136	138	0.9	2	B25620C1267K321
290	52	7.9	2.6	3.4	≤ 40	2.5	90	132	161	1	3	B25623B1297K304
310	65	14.3	4.8	2	≤ 40	2.3	116	95	101	1.13	4	B25620B1317K323
330	52	7.9	2.6	3.6	≤ 60	2.3	90	145	174	1.2	3	B25623B1337K304
340	70	14.8	5	2.5	≤ 60	2.1	85	173	179	1.05	1	B25620B1347K321
340	70	14.8	5	2.5	≤ 60	2.1	85	177	179	1.08	2	B25620C1347K321
370	50	15.7	5.2	2.3	≤ 60	2.0	90	173	202	1.3	3	B25623B0377K304
420	65	14.1	4.7	2.6	≤ 40	2.2	116	120	126	1.4	4	B25620B1427K323
480	70	14.1	4.7	2.6	≤ 40	2.1	116	132	138	1.55	4	B25620B1487K323
660	100	27.8	9.3	1.3	≤ 90	2.0	116	173	179	2.05	4	B25620B1667K323
1000	100	26.4	8.8	1.6	≤ 90	1.5	116	273	279	2.8	4	B25620B1108K323

¹ I_{MAX} at $\Theta 40 \text{ }^\circ\text{C}$, refer to "current derating" section for more details

² ESR at 1 kHz (typical value)

Other configurations and capacitance tolerances available upon request

$V_{RDC} = 1980 \text{ V DC} / V_{TT} = 2970 \text{ V DC}, 10 \text{ s} / V_{TC} = 4000 \text{ V AC}, 10 \text{ s}$

C_R μF	I_{MAX}^1 A	I_s kA	\hat{I} kA	ESR ² m Ω	L_{self} nH	R_{TH} K/W	D mm	H _c mm	H _r mm	Weight kg	Fig.	Ordering Code
40	35	4.5	1.5	6.0	≤ 60	4.0	85	70	76	0.45	1	B25620B1406K981
40	35	4.5	1.5	6.0	≤ 60	4.0	85	74	76	0.48	2	B25620C1406K981
70	40	4.9	1.6	5.6	≤ 60	3.3	85	95	101	0.58	1	B25620B1706K981
70	40	4.9	1.6	5.6	≤ 60	3.3	85	99	101	0.61	2	B25620C1706K981
145	50	10.0	3.4	2.8	≤ 60	2.1	85	173	179	1.05	1	B25620B1147K981
145	50	10.0	3.4	2.8	≤ 60	2.1	85	177	179	1.08	2	B25620C1147K981
190	60	18.9	6.3	3.2	≤ 60	2.2	116	120	126	1.4	4	B25620B1197K983
215	60	9.6	3.2	3.4	≤ 40	2.1	116	132	138	1.55	4	B25620B1217K983
295	80	18.8	6.3	1.7	≤ 60	2.0	116	173	179	2.05	4	B25620B1297K983
460	100	18.2	6	2.9	≤ 90	1.7	116	263	269	2.6	4	B25620B1467K983
510	100	19.3	6.4	3.0	≤ 90	1.5	116	273	279	2.8	4	B25620B1517K983

¹ I_{MAX} at $\Theta 40 \text{ }^\circ\text{C}$, refer to “current derating” section for more details

² ESR at 1 kHz (typical value)

Other configurations and capacitance tolerances available upon request

Display of ordering codes for EPCOS products

The ordering code for one and the same EPCOS product can be represented differently in data sheets, data books, other publications, on the EPCOS website, or in order-related documents such as shipping notes, order confirmations and product labels. The varying representations of the ordering codes are due to different processes employed and do not affect the specifications of the respective products. Detailed information can be found on the Internet under www.epcos.com/orderingcodes

2. Service life

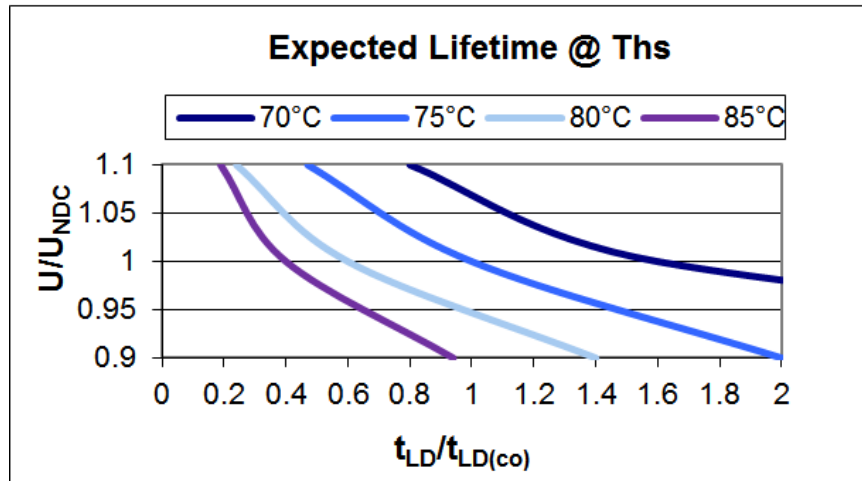

Service life t_{LD} at different hotspot temperature (Θ_{hs}) and voltage V

For capacitors with diameter 116mm a maximum hot spot temperature of 85 °C is allowed during short term operation (maximum 10% of the total load duration) without further reduction of the service life.

The expected lifetime is a calculated value based on real application data and life endurance test for this capacitor series. The lifetime calculation correlates the time of test, voltage and temperature always comparing testing conditions to real application data and its own ageing factors. In order to determine the ageing factor used for this capacitor design it was performed life endurance tests with different stress is voltage and temperature. Failure criteria is capacitance drop higher than 3%.

3. Current derating

3.1 Current derating graphs for capacitors 700 V_{R DC}

B25620B0287K701

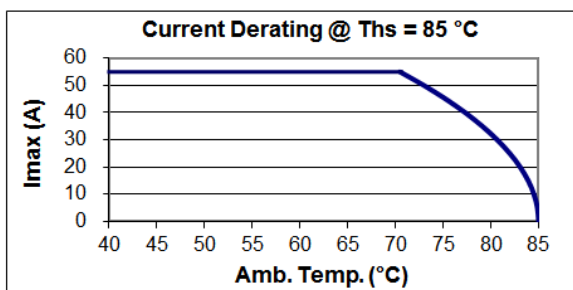

B25620B0627K701

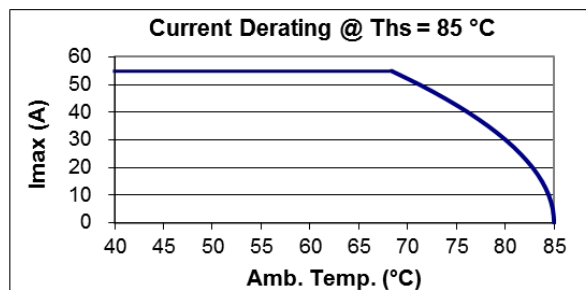

B25620B0707K701

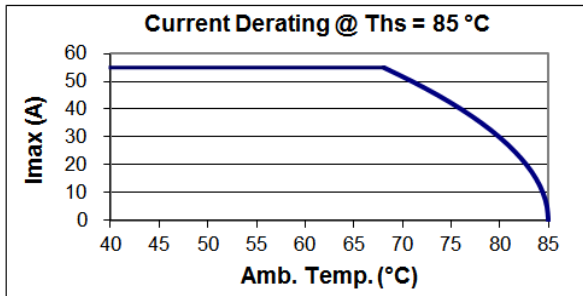

B25620B0567K703

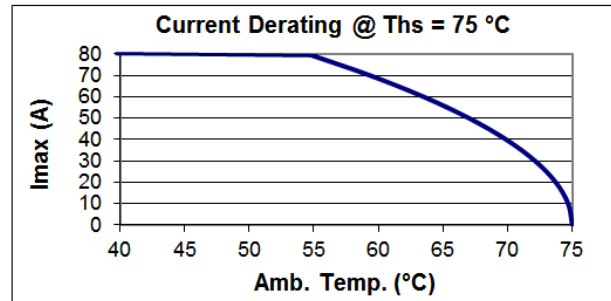

B25620B0907K703

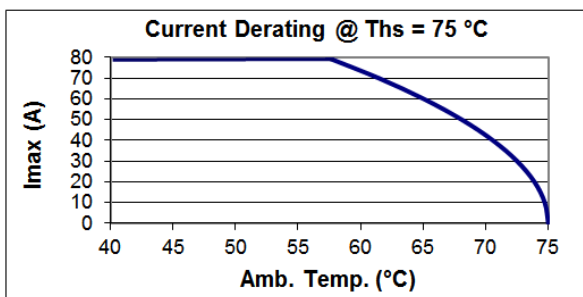

B25620B0128K743

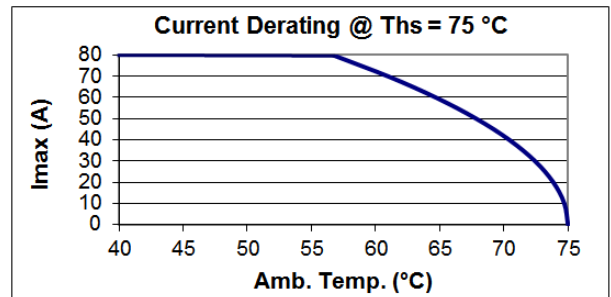

B25620B0148K703

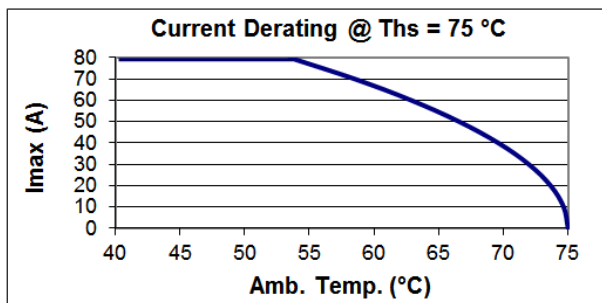

B25620B0507K704

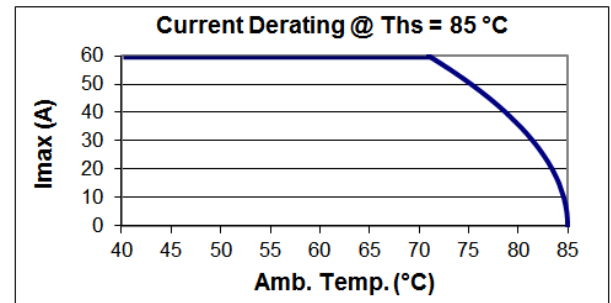

B25620B0787K704

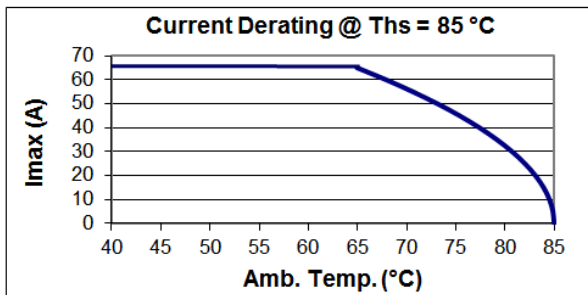

3.2 Current derating graphs for capacitors 900 V_{NDC}

B25620B0227K881/B25620C0227K881

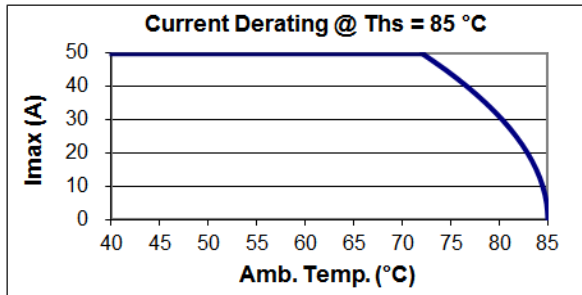

B25620B0357K881/B25620C0357K881

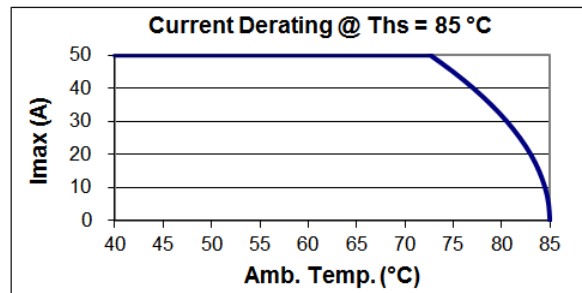

B25623B0427K904

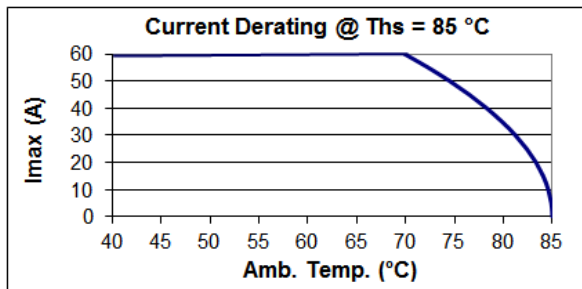

B25620B0447K883

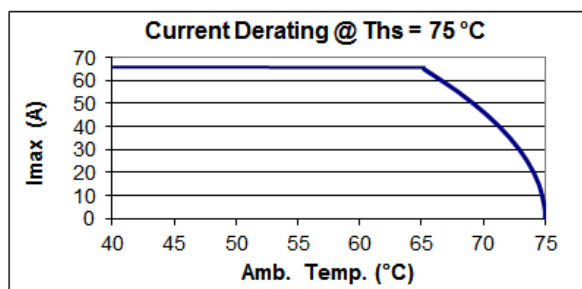

B25620B0487K881/B25620C0487K881

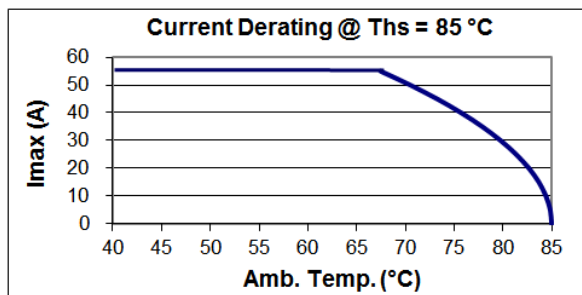

B25620B0557K881/B25620C0557K881

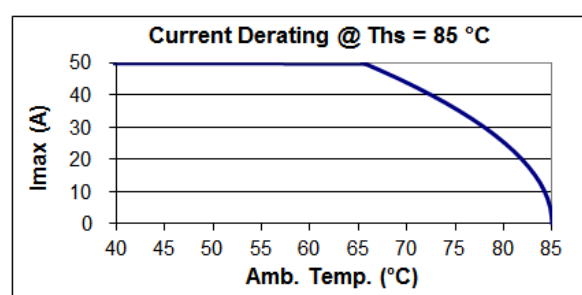

B25623B0587K904

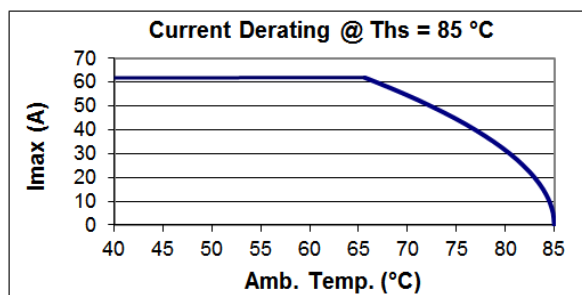

B25623B0657K904

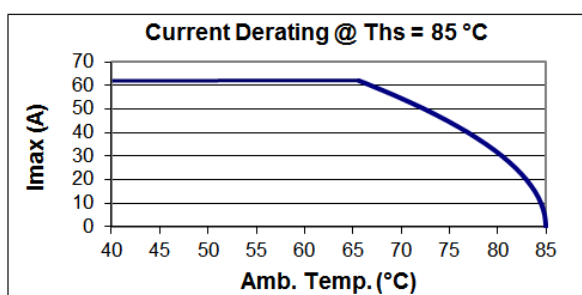

B25620B0707K883

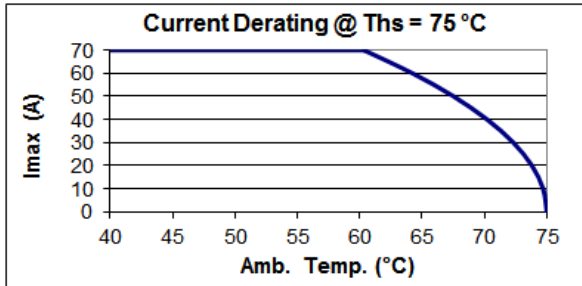

B25623B0737K904

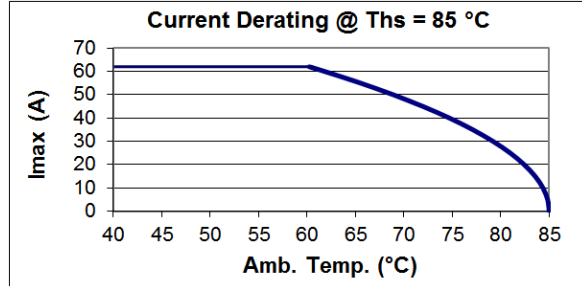

B25620B0757K881/B25620C0757K881

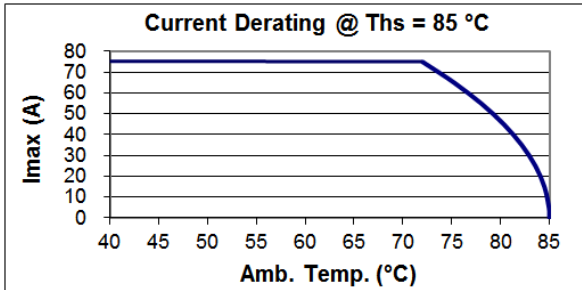

B25623B0837K904

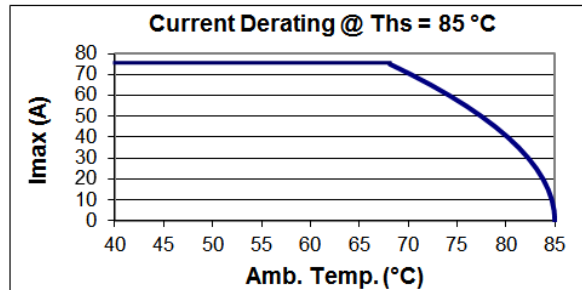

B25620B0977K883

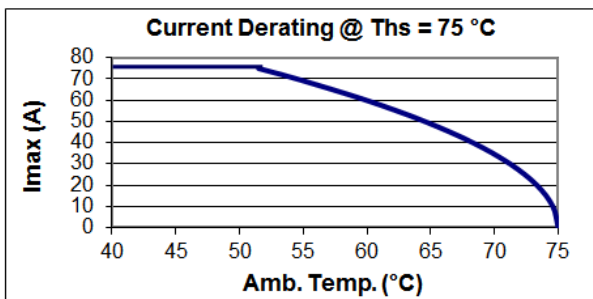

B25620B0118K883

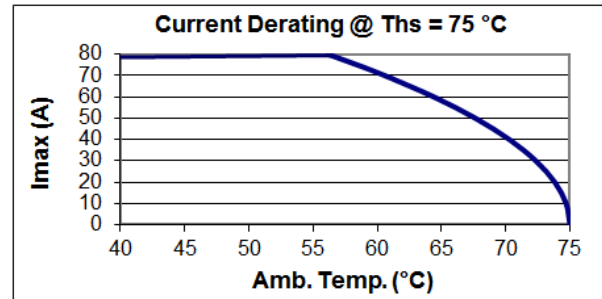

B25620B0158K883/B25620C0158K883

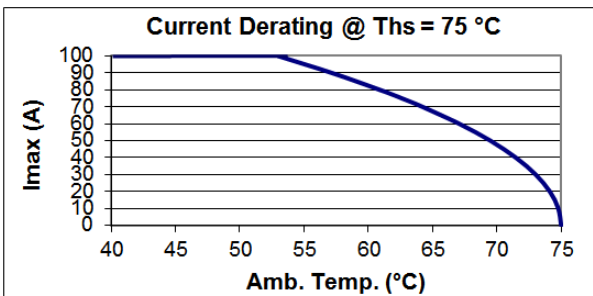

3.3 Current derating graphs for capacitors 1100 V_{NDC}

B25620B1147K101

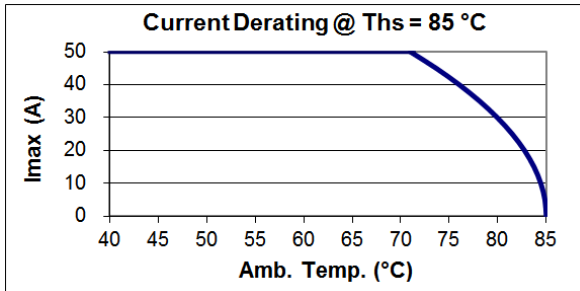

B25620B1287K103

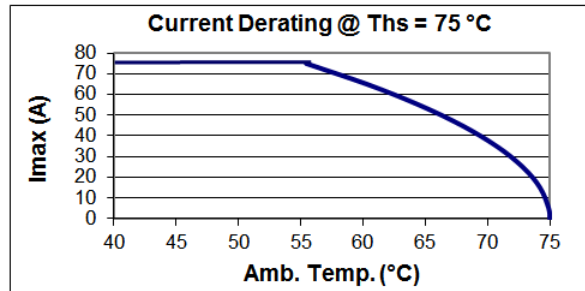

B25620B1317K101

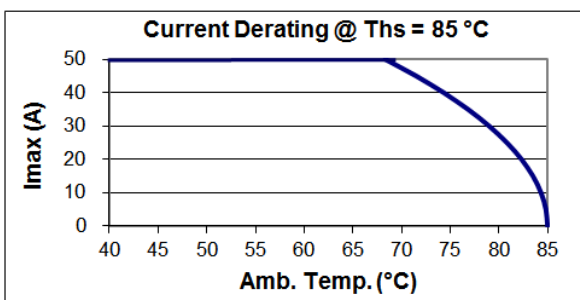

B25620B1427A101

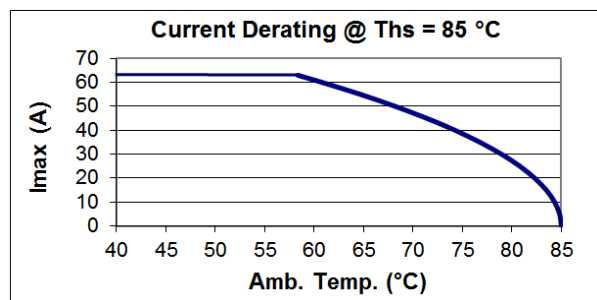

B25620B1427K101

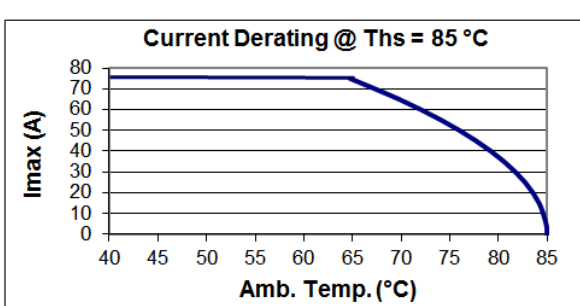

B25620D1457K101

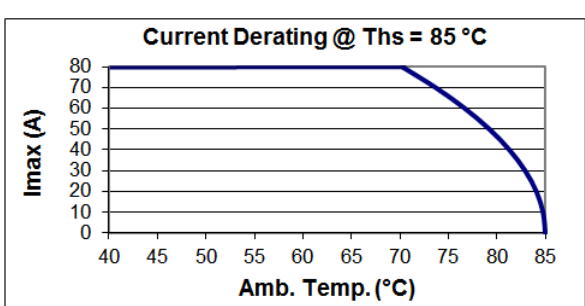

B25620B1457K103

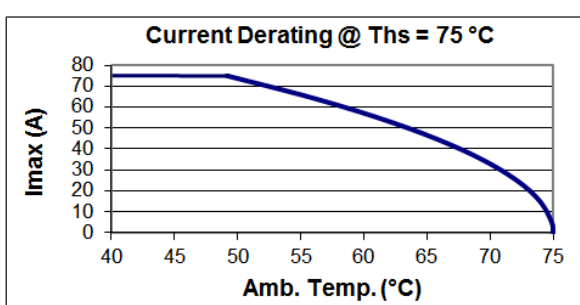

B25620B1487K101

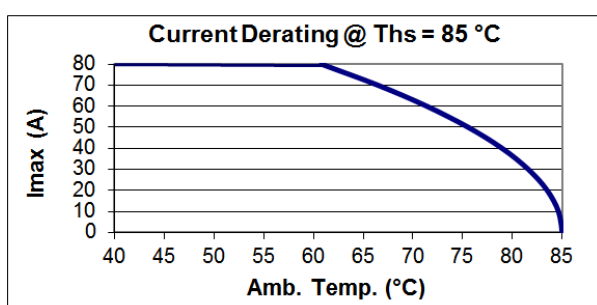

B25620B1617K103

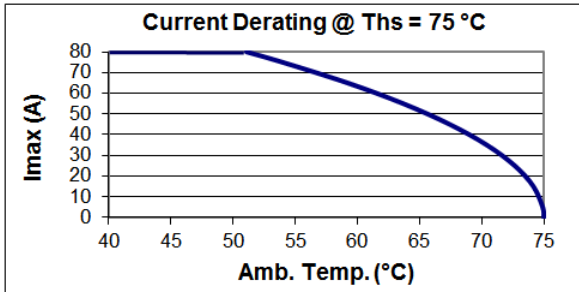

B25620D1617K101

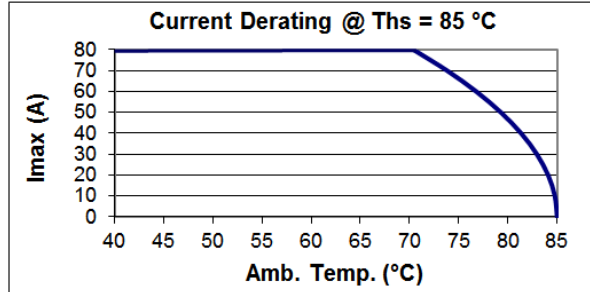

B25620B1707K103

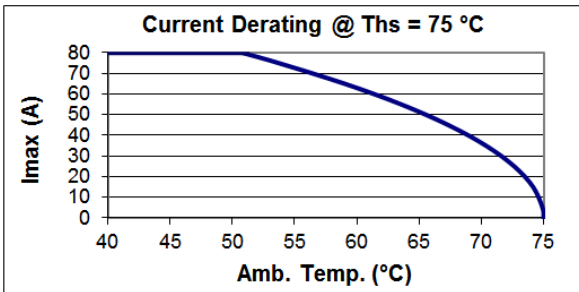

B25620D1707K103

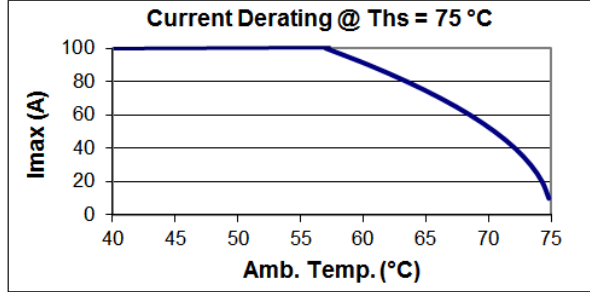

B25620B1947K103

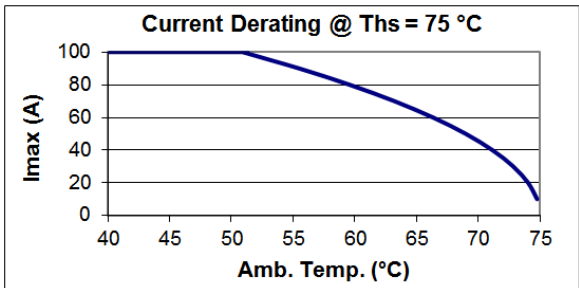

B25620B1118K103

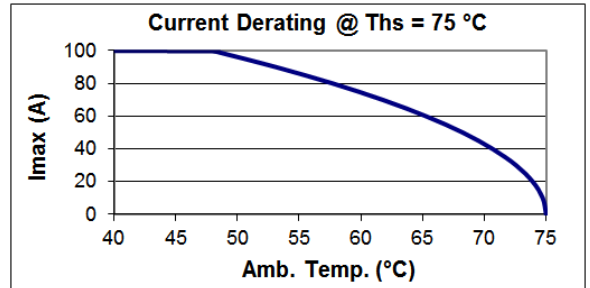

B25620B1158K103

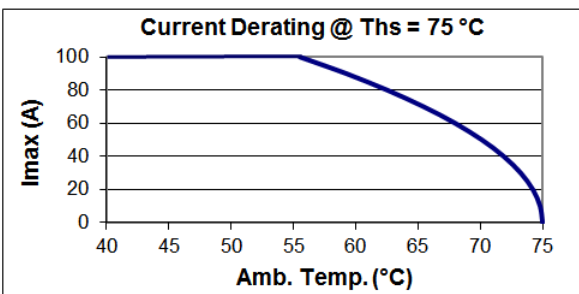

B25623B1227K104

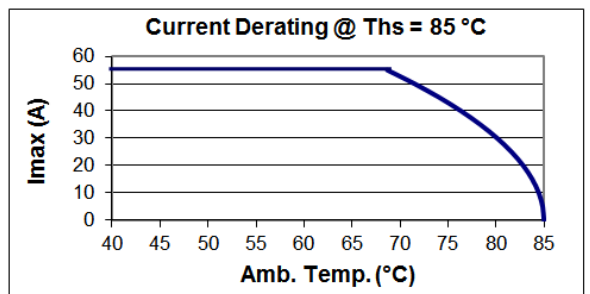

B25623B1277K104

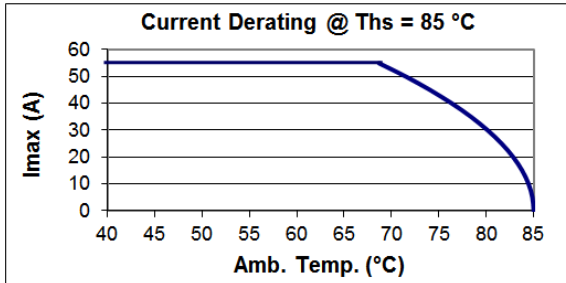

B25623B1377K104

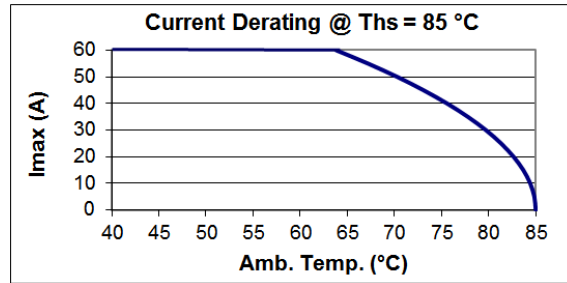

B25623B1427K104

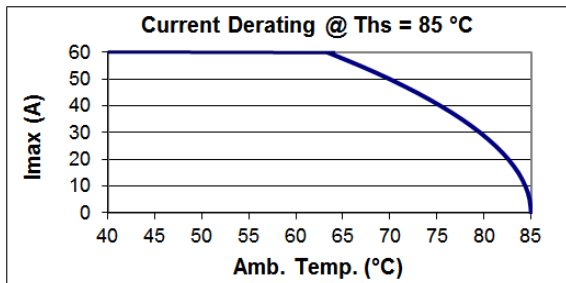

B25623B1477K104

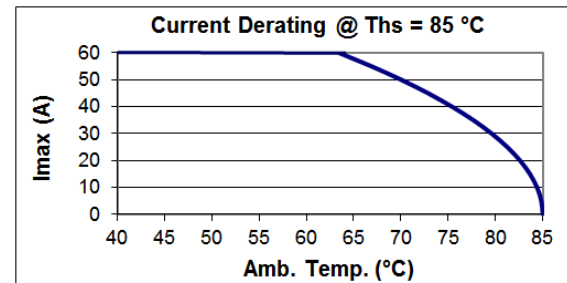

B25623B1537K104

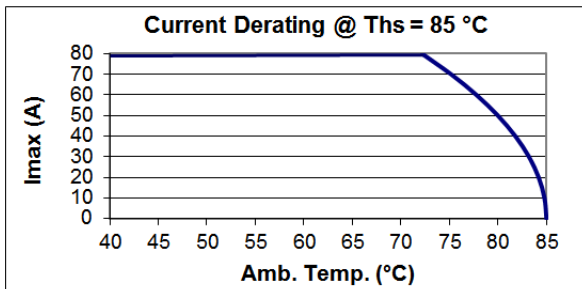

3.4 Current derating graphs for capacitors 1200 V_{R DC}

B25623B1227K204

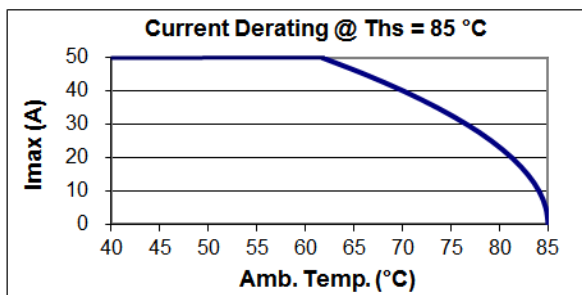

B25623B1307K204

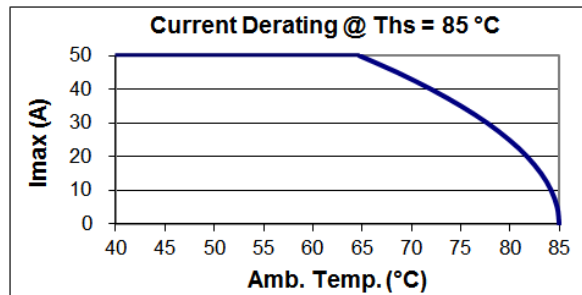

B25623B1347K204

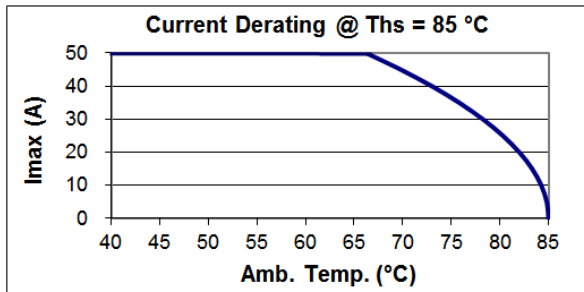

B25623B1447K204

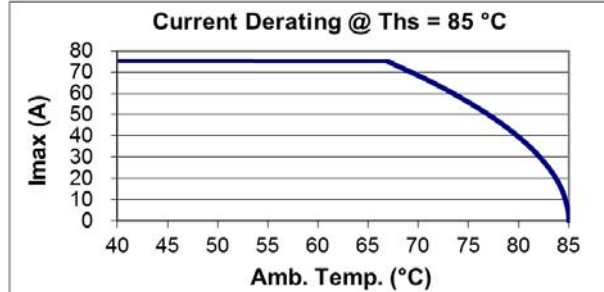

B25623B1557K204

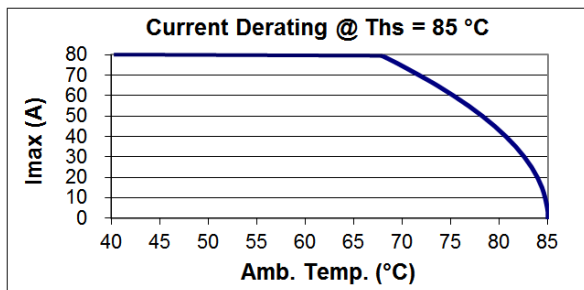

B25620B1367K203

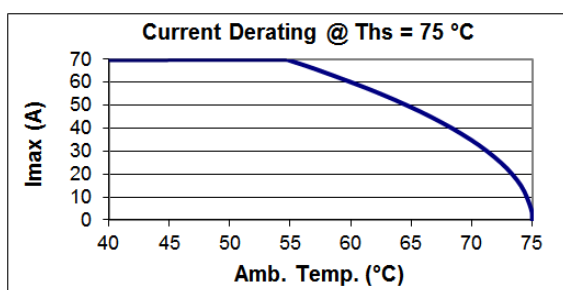

B25620B1507K203

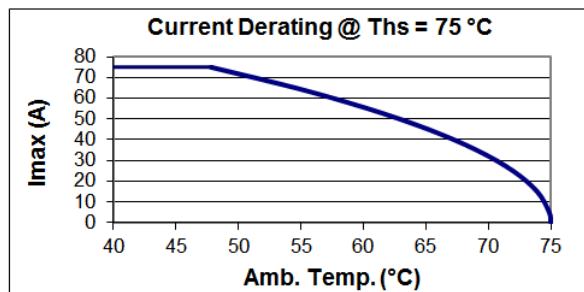

B25620B1577K203

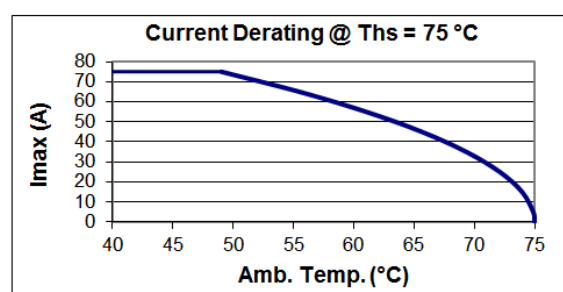

B25620B1737K203

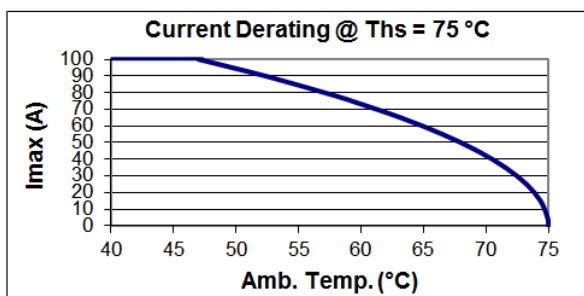

B25620B1108K203

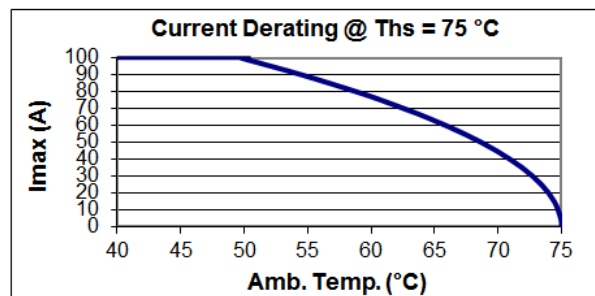

Current derating graphs for capacitors rated 1320 / 1980 V_{R DC} are available upon request.

FIT

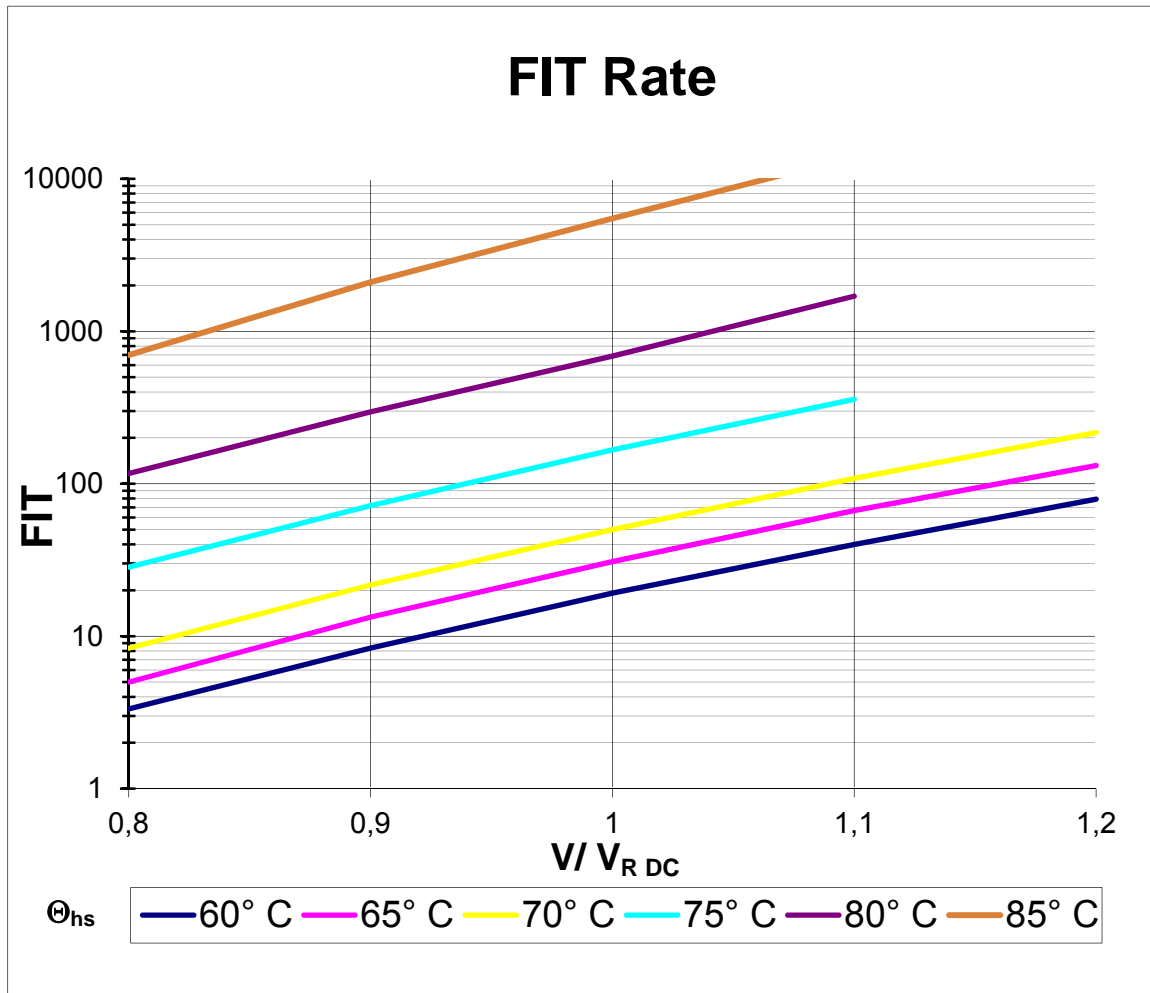

The FIT (Failure In Time) of a component is defined as the number of expected failures in 10⁹ hours of operation. The FIT rate is calculated on the basis of the number of components operating in the field and the estimated hours of operation. All the reports of failures are taken into consideration for this calculation, which is updated every year. The other values in the graph are given as indication and calculated based on acceleration factors. Failure criteria is capacitance drop higher than 3%.

Cautions and warnings

- In case of dents of more than 1 mm depth or any other mechanical damage, capacitors must not be used at all.
- Check tightness of the connections/terminals periodically.
- The energy stored in capacitors may be lethal. To prevent any chance of shock, discharge and short-circuit the capacitor before handling.
- Failure to follow cautions may result, worst case, in premature failures, bursting and fire.
- EPCOS AG is not responsible for any kind of possible damages to persons or things due to improper installation and application of capacitors for power electronics.

Safety

- Electrical or mechanical misapplication of capacitors may be hazardous. Personal injury or property damage may result from bursting of the capacitor or from expulsion of oil or melted material due to mechanical disruption of the capacitor.
- Ensure good, effective grounding for capacitor enclosures.
- Observe appropriate safety precautions during operation (self-recharging phenomena and the high energy contained in capacitors).
- Handle capacitors carefully, because they may still be charged even after disconnection.
- The terminals of capacitors, connected bus bars and cables as well as other devices may also be energized.
- Follow good engineering practice.

Thermal load

After installation of the capacitor it is necessary to verify that maximum hot-spot temperature is not exceeded at extreme service conditions.

Mechanical protection

The capacitor has to be installed in a way that mechanical damages and dents in the aluminum can are avoided.

Storage and operating conditions

Do not use or store capacitors in corrosive atmosphere, especially where chloride gas, sulfide gas, acid, alkali, salt or the like are present. In dusty environments regular maintenance and cleaning especially of the terminals is required to avoid conductive path between phases and/or phases and ground.

The maximum storage temperature is 85 °C.

Service life expectancy

Electrical components do not have an unlimited service life expectancy; this applies to self-healing capacitors, too. The maximum service life expectancy may vary depending on the application the capacitor is used in.

Important notes

The following applies to all products named in this publication:

1. Some parts of this publication contain **statements about the suitability of our products for certain areas of application**. These statements are based on our knowledge of typical requirements that are often placed on our products in the areas of application concerned. We nevertheless expressly point out **that such statements cannot be regarded as binding statements about the suitability of our products for a particular customer application**. As a rule, EPCOS is either unfamiliar with individual customer applications or less familiar with them than the customers themselves. For these reasons, it is always ultimately incumbent on the customer to check and decide whether an EPCOS product with the properties described in the product specification is suitable for use in a particular customer application.
2. We also point out that **in individual cases, a malfunction of electronic components or failure before the end of their usual service life cannot be completely ruled out in the current state of the art, even if they are operated as specified**. In customer applications requiring a very high level of operational safety and especially in customer applications in which the malfunction or failure of an electronic component could endanger human life or health (e.g. in accident prevention or life-saving systems), it must therefore be ensured by means of suitable design of the customer application or other action taken by the customer (e.g. installation of protective circuitry or redundancy) that no injury or damage is sustained by third parties in the event of malfunction or failure of an electronic component.
3. **The warnings, cautions and product-specific notes must be observed.**
4. In order to satisfy certain technical requirements, **some of the products described in this publication may contain substances subject to restrictions in certain jurisdictions (e.g. because they are classed as hazardous)**. Useful information on this will be found in our Material Data Sheets on the Internet (www.epcos.com/material). Should you have any more detailed questions, please contact our sales offices.
5. We constantly strive to improve our products. Consequently, **the products described in this publication may change from time to time**. The same is true of the corresponding product specifications. Please check therefore to what extent product descriptions and specifications contained in this publication are still applicable before or when you place an order. We also **reserve the right to discontinue production and delivery of products**. Consequently, we cannot guarantee that all products named in this publication will always be available. The aforementioned does not apply in the case of individual agreements deviating from the foregoing for customer-specific products.
6. Unless otherwise agreed in individual contracts, **all orders are subject to the current version of the "General Terms of Delivery for Products and Services in the Electrical Industry" published by the German Electrical and Electronics Industry Association (ZVEI)**.
7. The trade names EPCOS, Alu-X, CeraDiode, CeraLink, CeraPad, CeraPlas, CSMP, CSSP, CTVS, DeltaCap, DigiSiMic, DSSP, ExoCore, FilterCap, FormFit, LeaXield, MiniBlue, MiniCell, MKD, MKK, MotorCap, PCC, PhaseCap, PhaseCube, PhaseMod, PhiCap, PQSine, SIFERRIT, SIFI, SIKOREL, SilverCap, SIMDAD, SiMic, SIMID, SineFormer, SIOV, SIP5D, SIP5K, TFAP, ThermoFuse, WindCap are **trademarks registered or pending** in Europe and in other countries. Further information will be found on the Internet at www.epcos.com/trademarks.