

## Ceramic transient voltage suppressors

SMD multilayer transient voltage suppressors,  
standard series

The following products presented in this data sheet are being withdrawn.

Ordering Code	Substitute Product	Date of Withdrawal	Deadline Last Orders	Last Shipments
B72580V0110K062	B72580T0110K062	2012-11-09	2013-03-01	2013-06-01
B72580V0080L062	B72580T0080L062	2012-11-09	2013-03-01	2013-06-01
B72580V0060M062	B72580T0040M062	2012-11-09	2013-03-01	2013-06-01

© EPCOS AG 2015. Reproduction, publication and dissemination of this publication, enclosures hereto and the information contained therein without EPCOS' prior express consent is prohibited.

EPCOS AG is a TDK Group Company.



Ordering Code	Substitute Product	Date of Withdrawal	Deadline Last Orders	Last Shipments
B72580V0040M062	B72580T0040M062	2012-11-09	2013-03-01	2013-06-01
B72540V0080L062	B72540T0080L062	2012-11-09	2013-03-01	2013-06-01

For further information please contact your nearest EPCOS sales office, which will also support you in selecting a suitable substitute. The addresses of our worldwide sales network are presented at [www.epcos.com/sales](http://www.epcos.com/sales).

**Multilayer varistors (MLVs)**
**Standard series**
SMD
**EPCOS type designation system for standard series**

CT	0603	K	17	G	K2
<b>Construction:</b> CT $\triangleq$ Single chip with nickel barrier termination (AgNiSn) CN $\triangleq$ Single chip with silver-palladium termination (AgPd) CN...K2 $\triangleq$ Single chip with silver-platinum termination (AgPt)					
<b>Case sizes:</b> 0201 0402 0603 0805 1206 1210 1812 2220					
<b>Tolerance of the varistor voltage:</b> K $\triangleq$ $\pm 10\%$ L $\triangleq$ $\pm 15\%$ M $\triangleq$ $\pm 20\%$ S $\triangleq$ Special tolerance					
<b>Maximum RMS operating voltage (<math>V_{RMS}</math>):</b> 17 $\triangleq$ 17 V					
<b>Taping mode:</b> G $\triangleq$ 180-mm reel					
AgPt termination					

## Multilayer varistors (MLVs)

### Standard series

#### SMD

#### Features

- ESD acc. to IEC 61000-4-2 level 4 (8 kV contact, 15 kV air discharge)
- Surge current up to 1200 A
- Bidirectional protection
- No derating up to 125°C (for case sizes  $\geq$  0603)
- Fast response ( $<$  0.5 ns)
- RoHS-compatible
- CT version suitable for lead-free soldering
- PSpice simulation models available

#### Applications

- ESD protection in mobile phones, cordless phones and accessories
- ESD protection in data bus applications
- ESD protection in control electronics, detectors and sensors, touch screens, plug-in cards, remote controls

#### Design

- Multilayer technology
- Lack of plastic or epoxy encapsulation for flammability rating better than UL 94 V-0
- Termination (see "Soldering directions"):
  - CT types with nickel barrier terminations (AgNiSn), recommended for lead-free soldering, and compatible with tin/lead solder.
  - CN types with silver-palladium terminations (AgPd) only suitable for reflow and wave soldering with solder on tin/lead basis.
  - CN...K2 types with silver-platinum terminations (AgPt) suitable for reflow lead-free soldering.

#### V/I characteristics and derating curves

V/I and derating curves are attached to the data sheet. The curves are sorted by  $V_{RMS}$  and then by case size, which is included in the type designation.

#### Single chip

##### Internal circuit

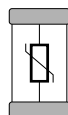

MLV0006-H

##### Available case sizes:

EIA	Metric
0201	0603
0402	1005
0603	1608
0805	2012
1206	3216
1210	3225
1812	4532
2220	5750

**Multilayer varistors (MLVs)**
**Standard series**
**SMD**
**General technical data**

Maximum RMS operating voltage		$V_{RMS,max}$	4 ... 60	V
Maximum DC operating voltage		$V_{DC,max}$	5.5 ... 85	V
Maximum surge current	(8/20 $\mu$ s)	$I_{surge,max}$	10 ... 1200	A
Maximum energy absorption	(2 ms)	$W_{max}$	7.5 ... 12000	mJ
Maximum power dissipation		$P_{diss,max}$	3 ... 20	mW
Maximum clamping voltage	(8/20 $\mu$ s)	$V_{clamp,max}$	17 ... 165	V
Operating temperature	for case size 0201, 0402	$T_{op}$	-40/+85	$^{\circ}$ C
	for case size $\geq$ 0603	$T_{op}$	-55/+125	$^{\circ}$ C
Storage temperature	for case size 0201, 0402	LCT/UCT	-40/+125	$^{\circ}$ C
	for case size $\geq$ 0603	LCT/UCT	-55/+150	$^{\circ}$ C

## Multilayer varistors (MLVs)

### Standard series

### SMD

#### Temperature derating

Climatic category:

–40/+85 °C for case size 0201 and 0402

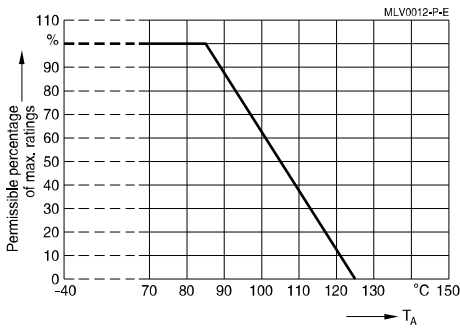

Climatic category:

–55/+125 °C for case size  $\geq 0603$

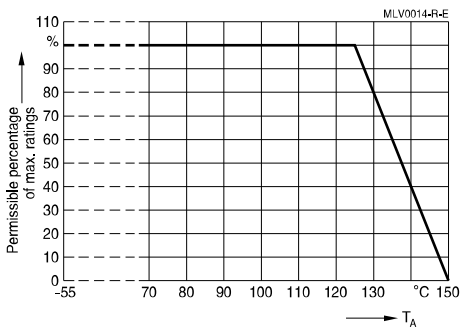

**Multilayer varistors (MLVs)**
**Standard series**
SMD
**Electrical specifications and ordering codes**
**Maximum ratings ( $T_{op,max}$ )**

Type	Ordering code	$V_{RMS,max}$	$V_{DC,max}$	$I_{surge,max}$ (8/20 $\mu$ s)	$W_{max}$ (2 ms)	$P_{diss,max}$	$T_{op,max}$
		V	V	A	mJ	mW	$^{\circ}$ C
<b>CN standard series</b>							
CN1812M4G	B72580V0040M062	4	5.5	500	800	15	+125
CN2220M4G	B72540V0040M062	4	5.5	1000	1400	20	+125
CN1812M6G	B72580V0060M062	6	8	500	1000	15	+125
CN2220M6G	B72540V0060M062	6	8	1200	3600	20	+125
CN1812L8G	B72580V0080L062	8	11	800	1800	15	+125
CN2220L8G	B72540V0080L062	8	11	1200	4200	20	+125
CN1812K11G	B72580V0110K062	11	14	800	1900	15	+125
CN2220K11G	B72540V0110K062	11	14	1200	5400	20	+125
CN1812K14G	B72580V0140K062	14	18	800	2300	15	+125
CN1812K14GK2	B72582V0140K062	14	18	800	2300	15	+125
CN2220K14G	B72540V0140K062	14	18	1200	5800	20	+125
CN1812K17G	B72580V0170K062	17	22	800	2700	15	+125
CN2220K17G	B72540V0170K062	17	22	1200	7200	20	+125
CN1812K20G	B72580V0200K062	20	26	800	3000	15	+125
CN2220K20G	B72540V0200K062	20	26	1200	7800	20	+125
CN2220K20GK2	B72542V0200K062	20	26	1200	7800	20	+125
CN1812K25G	B72580V0250K062	25	31	800	3700	15	+125
CN2220K25G	B72540V0250K062	25	31	1200	9600	20	+125
CN2220K25GK2	B72542V0250K062	25	31	1200	9600	20	+125
CN1812K30G	B72580V0300K062	30	38	800	4200	15	+125
CN1812K30GK2	B72582V0300K062	30	38	800	4200	15	+125
CN2220K30G	B72540V0300K062	30	38	1200	12000	20	+125
CN2220K30GK2	B72542V0300K062	30	38	1200	12000	20	+125
CN1812K35GK2	B72582V0350K062	35	45	500	4000	15	+125
CN2220K35GK2	B72542V0350K062	35	45	1000	7700	20	+125
CN2220K40GK2	B72542V0400K062	40	56	1000	9000	20	+125
<b>CT standard series</b>							
CT0201S4AG	B72440T0040S160	4	5.5	-	-	-	+85
CT0402M4G	B72590T0040M060	4	5.5	20	7.5	3	+85
CT0603M4G	B72500T0040M060	4	5.5	30	100	3	+125
CT0805M4G	B72510T0040M062	4	5.5	100	100	5	+125
CT1206M4G	B72520T0040M062	4	5.5	150	300	8	+125
CT1210M4G	B72530T0040M062	4	5.5	250	400	10	+125
CT0603M6G	B72500T0060M060	6	8	30	100	3	+125

**Multilayer varistors (MLVs)**
**Standard series**
**SMD**
**Characteristics (T<sub>A</sub> = 25 °C)**

Type	V <sub>V</sub> (1 mA) V	ΔV <sub>V</sub> %	V <sub>clamp,max</sub> V	I <sub>clamp</sub> (8/20 μs) A	C <sub>typ</sub> (1 kHz, 1 V) pF
<b>CN standard series</b>					
CN1812M4G	8	±20	17	5	10000
CN2220M4G	8	±20	17	10	24000
CN1812M6G	11	±20	25	5	8000
CN2220M6G	11	±20	25	10	20000
CN1812L8G	15	±15	30	5	6000
CN2220L8G	15	±15	30	10	16000
CN1812K11G	18	±10	33	5	5000
CN2220K11G	18	±10	33	10	12000
CN1812K14G	22	±10	38	5	4500
CN1812K14GK2	22	±10	38	5	4500
CN2220K14G	22	±10	38	10	10000
CN1812K17G	27	±10	44	5	4000
CN2220K17G	27	±10	44	10	9000
CN1812K20G	33	±10	54	5	3000
CN2220K20G	33	±10	54	10	7000
CN2220K20GK2	33	±10	54	10	7000
CN1812K25G	39	±10	65	5	2500
CN2220K25G	39	±10	65	10	5000
CN2220K25GK2	39	±10	65	10	5000
CN1812K30G	47	±10	77	5	2000
CN1812K30GK2	47	±10	77	5	2000
CN2220K30G	47	±10	77	10	4000
CN2220K30GK2	47	±10	77	10	4000
CN1812K35GK2	56	±10	90	5	1200
CN2220K35GK2	56	±10	90	10	2500
CN2220K40GK2	68	±10	110	10	2000
<b>CT standard series</b>					
CT0201S4AG	15	±20	35	1	22 <sup>1)</sup>
CT0402M4G	10	±20	24	1	200 <sup>1)</sup>
CT0603M4G	8	±20	19	1	200
CT0805M4G	8	±20	19	1	700
CT1206M4G	8	±20	17	1	1500
CT1210M4G	8	±20	17	2.5	5000
CT0603M6G	11	±20	27	1	200

1) Measured @ 1 MHz, 1 V



**Multilayer varistors (MLVs)**
**Standard series**
SMD
**Electrical specifications and ordering codes**
**Maximum ratings ( $T_{op,max}$ )**

Type	Ordering code	$V_{RMS,max}$	$V_{DC,max}$	$I_{surge,max}$ (8/20 $\mu$ s)	$W_{max}$ (2 ms)	$P_{diss,max}$	$T_{op,max}$
		V	V	A	mJ	mW	$^{\circ}$ C
<b>CT standard series</b>							
CT0805M6G	B72510T0060M062	6	8	120	200	5	+125
CT1206M6G	B72520T0060M062	6	8	200	400	8	+125
CT1210M6G	B72530T0060M062	6	8	300	700	10	+125
CT0603K7G	B72500T0070K060	7	9	30	100	3	+125
CT0603M7G	B72500T0070M060	7	9	30	100	3	+125
CT0603L8G	B72500T0080L060	8	11	30	100	3	+125
CT0805L8G	B72510T0080L062	8	11	120	200	5	+125
CT1206L8G	B72520T0080L062	8	11	200	500	8	+125
CT1210L8G	B72530T0080L062	8	11	400	1000	10	+125
CT0402S11AG	B72590T0110S160	11	14	20	7.5	3	+85
CT0603K11G	B72500T0110K060	11	14	30	200	3	+125
CT0805K11G	B72510T0110K062	11	14	120	200	5	+125
CT1206K11G	B72520T0110K062	11	14	200	500	8	+125
CT1210K11G	B72530T0110K062	11	14	400	1200	10	+125
CT0402L14G	B72590T0140L060	14	16	20	10	3	+85
CT0402L14UG	B72590T0140L960	14	16	10	10	3	+85
CT0603K14G	B72500T0140K060	14	18	30	200	3	+125
CT0603S14BG	B72500T0140S160	14	18	30	200	3	+125
CT0805K14G	B72510T0140K062	14	18	120	300	5	+125
CT1206K14G	B72520T0140K062	14	18	200	500	8	+125
CT1210K14G	B72530T0140K062	14	18	400	1500	10	+125
CT0402S17AG	B72590T0170S160	17	19	20	10	3	+85
CT0603K17G	B72500T0170K060	17	22	30	200	3	+125
CT0805K17G	B72510T0170K062	17	22	120	300	5	+125
CT1206K17G	B72520T0170K062	17	22	200	600	8	+125
CT1210K17G	B72530T0170K062	17	22	400	1700	10	+125
CT0603K20G	B72500T0200K060	20	26	30	200	3	+125
CT0805K20G	B72510T0200K062	20	26	80	300	5	+125
CT1206K20G	B72520T0200K062	20	26	200	700	8	+125
CT1210K20G	B72530T0200K062	20	26	400	1900	10	+125
CT0603K25G	B72500T0250K060	25	31	30	300	3	+125
CT0805K25G	B72510T0250K062	25	31	80	300	5	+125
CT1206K25G	B72520T0250K062	25	31	200	1000	8	+125
CT1210K25G	B72530T0250K062	25	31	300	1700	10	+125
CT0805K30G	B72510T0300K062	30	38	80	300	5	+125

**Multilayer varistors (MLVs)**
**Standard series**
**SMD**
**Characteristics (T<sub>A</sub> = 25 °C)**

Type	V <sub>V</sub> (1 mA) V	ΔV <sub>V</sub> %	V <sub>clamp,max</sub> V	I <sub>clamp</sub> (8/20 μs) A	C <sub>typ</sub> (1 kHz, 1 V) pF
<b>CT standard series</b>					
CT0805M6G	11	±20	27	1	600
CT1206M6G	11	±20	25	1	1200
CT1210M6G	11	±20	25	2.5	4000
CT0603K7G	12.5	±10	27	1	130
CT0603M7G	12.5	±20	30	1	200
CT0603L8G	15	±15	33	1	150
CT0805L8G	15	±15	33	1	500
CT1206L8G	15	±15	30	1	1000
CT1210L8G	15	±15	30	2.5	3000
CT0402S11AG	18.4	±10	35	1	120 <sup>1)</sup>
CT0603K11G	18	±10	35	1	100
CT0805K11G	18	±10	35	1	400
CT1206K11G	18	±10	33	1	800
CT1210K11G	18	±10	33	2.5	2400
CT0402L14G	23.5	±15	46	1	47 <sup>1)</sup>
CT0402L14UG	23.5	±15	46	1	47 <sup>1)</sup>
CT0603K14G	22	±10	40	1	100
CT0603S14BG	22	+23/-0	42	1	120
CT0805K14G	22	±10	40	1	350
CT1206K14G	22	±10	38	1	700
CT1210K14G	22	±10	38	2.5	2000
CT0402S17AG	32	±25	59	1	33 <sup>1)</sup>
CT0603K17G	27	±10	46	1	100
CT0805K17G	27	±10	46	1	400
CT1206K17G	27	±10	44	1	650
CT1210K17G	27	±10	44	2.5	1800
CT0603K20G	33	±10	56	1	90
CT0805K20G	33	±10	56	1	300
CT1206K20G	33	±10	54	1	600
CT1210K20G	33	±10	54	2.5	1500
CT0603K25G	39	±10	67	1	90 <sup>1)</sup>
CT0805K25G	39	±10	67	1	250
CT1206K25G	39	±10	65	1	550
CT1210K25G	39	±10	65	2.5	1200
CT0805K30G	47	±10	77	1	200

1) Measured @ 1 MHz, 1 V

**Multilayer varistors (MLVs)**
**Standard series**
SMD
**Electrical specifications and ordering codes**
**Maximum ratings ( $T_{op,max}$ )**

Type	Ordering code	$V_{RMS,max}$ V	$V_{DC,max}$ V	$I_{surge,max}$ (8/20 $\mu$ s) A	$W_{max}$ (2 ms) mJ	$P_{diss,max}$ mW	$T_{op,max}$ $^{\circ}$ C
<b>CT standard series</b>							
CT1206K30G	B72520T0300K062	30	38	200	1100	8	+125
CT1210K30G	B72530T0300K062	30	38	300	2000	10	+125
CT1206K35G	B72520T0350K062	35	45	100	400	8	+125
CT1210K35G	B72530T0350K062	35	45	250	2000	10	+125
CT1206K40G	B72520T0400K062	40	56	100	500	8	+125
CT1210K40G	B72530T0400K062	40	56	250	2300	10	+125
CT1206K50G	B72520T0500K062	50	65	100	600	8	+125
CT1210K50G	B72530T0500K062	50	65	200	1600	10	+125
CT1206K60G	B72520T0600K062	60	85	100	700	8	+125
CT1210K60G	B72530T0600K062	60	85	200	2000	10	+125

**Characteristics ( $T_A = 25^{\circ}$ C)**

Type	$V_V$ (1 mA) V	$\Delta V_V$ %	$V_{clamp,max}$ V	$I_{clamp}$ (8/20 $\mu$ s) A	$C_{typ}$ (1 kHz, 1 V) pF
<b>CT standard series</b>					
CT1206K30G	47	$\pm$ 10	77	1	500
CT1210K30G	47	$\pm$ 10	77	2.5	1000
CT1206K35G	56	$\pm$ 10	90	1	200
CT1210K35G	56	$\pm$ 10	90	2.5	600
CT1206K40G	68	$\pm$ 10	110	1	250
CT1210K40G	68	$\pm$ 10	110	2.5	500
CT1206K50G	82	$\pm$ 10	135	1	120
CT1210K50G	82	$\pm$ 10	135	2.5	250
CT1206K60G	100	$\pm$ 10	165	1	100
CT1210K60G	100	$\pm$ 10	165	2.5	200

## Multilayer varistors (MLVs)

### Standard series

### SMD

#### Dimensional drawing

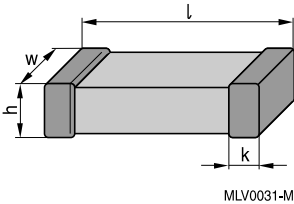

#### Dimensions in mm

Case size EIA / mm	l	w	h	k
0201 / 0603	0.6 ±0.03	0.30 ±0.03	0.33 max.	0.15 ±0.05
0402 / 1005	1.0 ±0.15	0.50 ±0.10	0.6 max.	0.10 ... 0.30
0603 / 1608	1.6 ±0.15	0.80 ±0.10	0.9 max.	0.10 ... 0.40
0805 / 2012	2.0 ±0.20	1.25 ±0.15	1.4 max.	0.13 ... 0.75
1206 / 3216	3.2 ±0.30	1.60 ±0.20	1.7 max.	0.25 ... 0.75
1210 / 3225	3.2 ±0.30	2.50 ±0.25	1.7 max.	0.25 ... 0.75
1812 / 4532	4.5 ±0.40	3.20 ±0.30	2.5 max.	0.25 ... 1.00
2220 / 5750	5.7 ±0.40	5.00 ±0.40	2.5 max.	0.25 ... 1.00

#### Recommended solder pad layout

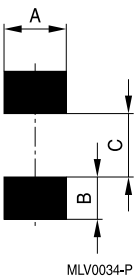

#### Dimensions in mm

Case size EIA / mm	A	B	C
0201 / 0603	0.30	0.25	0.30
0402 / 1005	0.60	0.60	0.50
0603 / 1608	1.00	1.00	1.00
0805 / 2012	1.40	1.20	1.00
1206 / 3216	1.80	1.20	2.10
1210 / 3225	2.80	1.20	2.10
1812 / 4532	3.60	1.50	3.00
2220 / 5750	5.50	1.50	4.20

**Multilayer varistors (MLVs)**
**Standard series**
SMD
**Delivery mode**

EIA case size	Taping	Reel size mm	Packing unit pcs.	Type	Ordering code
0201	Cardboard	180	15000	CT0201S4AG	B72440T0040S160
0402	Cardboard	180	10000	CT0402L14G	B72590T0140L060
0402	Cardboard	180	10000	CT0402L14UG	B72590T0140L960
0402	Cardboard	180	10000	CT0402M4G	B72590T0040M060
0402	Cardboard	180	10000	CT0402S11AG	B72590T0110S160
0402	Cardboard	180	10000	CT0402S17AG	B72590T0170S160
0603	Cardboard	180	4000	CT0603K11G	B72500T0110K060
0603	Cardboard	180	4000	CT0603K14G	B72500T0140K060
0603	Cardboard	180	4000	CT0603K17G	B72500T0170K060
0603	Cardboard	180	4000	CT0603K20G	B72500T0200K060
0603	Cardboard	180	4000	CT0603K25G	B72500T0250K060
0603	Cardboard	180	4000	CT0603K7G	B72500T0070K060
0603	Cardboard	180	4000	CT0603L8G	B72500T0080L060
0603	Cardboard	180	4000	CT0603M4G	B72500T0040M060
0603	Cardboard	180	4000	CT0603M6G	B72500T0060M060
0603	Cardboard	180	4000	CT0603M7G	B72500T0070M060
0603	Cardboard	180	4000	CT0603S14BG	B72500T0140S160
0805	Blister	180	3000	CT0805K11G	B72510T0110K062
0805	Blister	180	3000	CT0805K14G	B72510T0140K062
0805	Blister	180	3000	CT0805K17G	B72510T0170K062
0805	Blister	180	3000	CT0805K20G	B72510T0200K062
0805	Blister	180	3000	CT0805K25G	B72510T0250K062
0805	Blister	180	3000	CT0805K30G	B72510T0300K062
0805	Blister	180	3000	CT0805L8G	B72510T0080L062
0805	Blister	180	3000	CT0805M4G	B72510T0040M062
0805	Blister	180	3000	CT0805M6G	B72510T0060M062
1206	Blister	180	3000	CT1206K11G	B72520T0110K062
1206	Blister	180	3000	CT1206K14G	B72520T0140K062
1206	Blister	180	3000	CT1206K17G	B72520T0170K062
1206	Blister	180	3000	CT1206K20G	B72520T0200K062
1206	Blister	180	2000	CT1206K25G	B72520T0250K062
1206	Blister	180	2000	CT1206K30G	B72520T0300K062
1206	Blister	180	2000	CT1206K35G	B72520T0350K062
1206	Blister	180	2000	CT1206K40G	B72520T0400K062
1206	Blister	180	2000	CT1206K50G	B72520T0500K062
1206	Blister	180	2000	CT1206K60G	B72520T0600K062
1206	Blister	180	3000	CT1206L8G	B72520T0080L062
1206	Blister	180	3000	CT1206M4G	B72520T0040M062
1206	Blister	180	3000	CT1206M6G	B72520T0060M062
1210	Blister	180	3000	CT1210K11G	B72530T0110K062
1210	Blister	180	3000	CT1210K14G	B72530T0140K062
1210	Blister	180	3000	CT1210K17G	B72530T0170K062

**Multilayer varistors (MLVs)**
**Standard series**
SMD

EIA case size	Taping	Reel size mm	Packing unit pcs.	Type	Ordering code
1210	Blister	180	3000	CT1210K20G	B72530T0200K062
1210	Blister	180	2000	CT1210K25G	B72530T0250K062
1210	Blister	180	2000	CT1210K30G	B72530T0300K062
1210	Blister	180	2000	CT1210K35G	B72530T0350K062
1210	Blister	180	2000	CT1210K40G	B72530T0400K062
1210	Blister	180	2000	CT1210K50G	B72530T0500K062
1210	Blister	180	2000	CT1210K60G	B72530T0600K062
1210	Blister	180	3000	CT1210L8G	B72530T0080L062
1210	Blister	180	3000	CT1210M4G	B72530T0040M062
1210	Blister	180	3000	CT1210M6G	B72530T0060M062
1812	Blister	180	1500	CN1812K11G	B72580V0110K062
1812	Blister	180	1500	CN1812K14G	B72580V0140K062
1812	Blister	180	1500	CN1812K14GK2	B72582V0140K062
1812	Blister	180	1500	CN1812K17G	B72580V0170K062
1812	Blister	180	1500	CN1812K20G	B72580V0200K062
1812	Blister	180	1000	CN1812K25G	B72580V0250K062
1812	Blister	180	1000	CN1812K30G	B72580V0300K062
1812	Blister	180	1000	CN1812K30GK2	B72582V0300K062
1812	Blister	180	1000	CN1812K35GK2	B72582V0350K062
1812	Blister	180	1500	CN1812L8G	B72580V0080L062
1812	Blister	180	1500	CN1812M4G	B72580V0040M062
1812	Blister	180	1500	CN1812M6G	B72580V0060M062
2220	Blister	180	1500	CN2220K11G	B72540V0110K062
2220	Blister	180	1500	CN2220K14G	B72540V0140K062
2220	Blister	180	1500	CN2220K17G	B72540V0170K062
2220	Blister	180	1500	CN2220K20G	B72540V0200K062
2220	Blister	180	1500	CN2220K20GK2	B72542V0200K062
2220	Blister	180	1000	CN2220K25G	B72540V0250K062
2220	Blister	180	1000	CN2220K25GK2	B72542V0250K062
2220	Blister	180	1000	CN2220K30G	B72540V0300K062
2220	Blister	180	1000	CN2220K30GK2	B72542V0300K062
2220	Blister	180	1000	CN2220K35GK2	B72542V0350K062
2220	Blister	180	1000	CN2220K40GK2	B72542V0400K062
2220	Blister	180	1500	CN2220L8G	B72540V0080L062
2220	Blister	180	1500	CN2220M4G	B72540V0040M062
2220	Blister	180	1500	CN2220M6G	B72540V0060M062

Multilayer varistors (MLVs)

Standard series

SMD

V/I characteristics

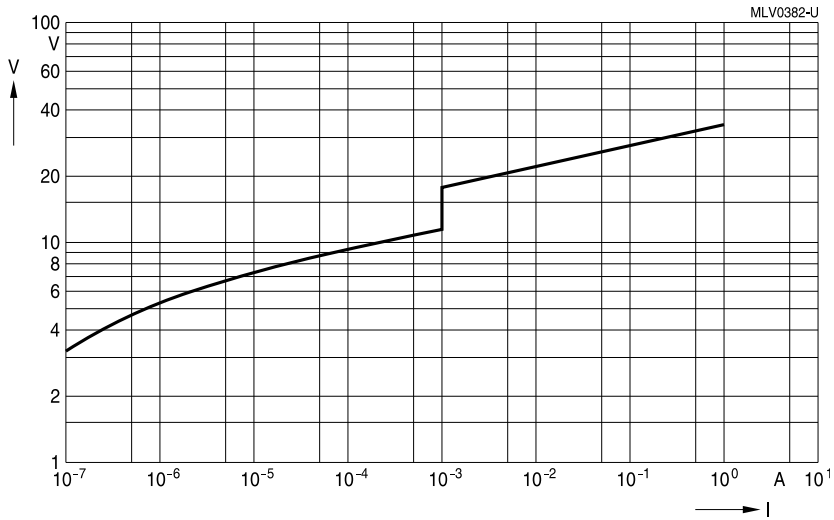

CT0201S4AG

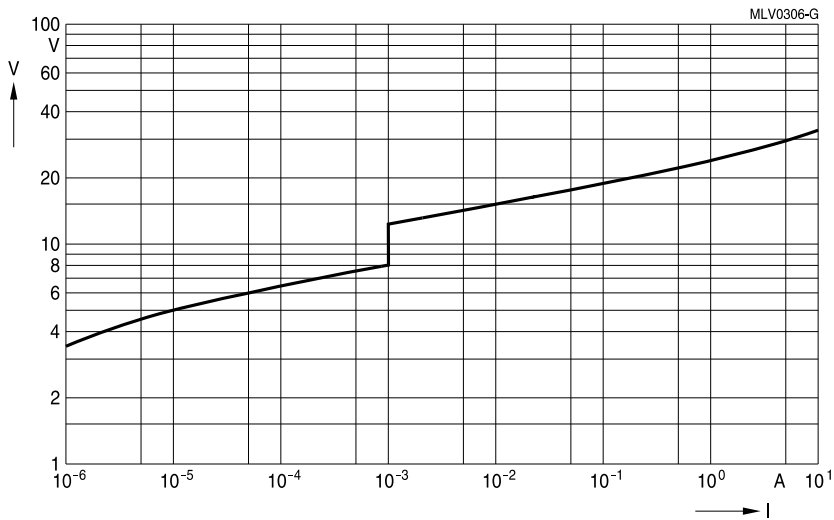

CT0402M4G

**Multilayer varistors (MLVs)**

**Standard series**

**SMD**

**V/I characteristics**

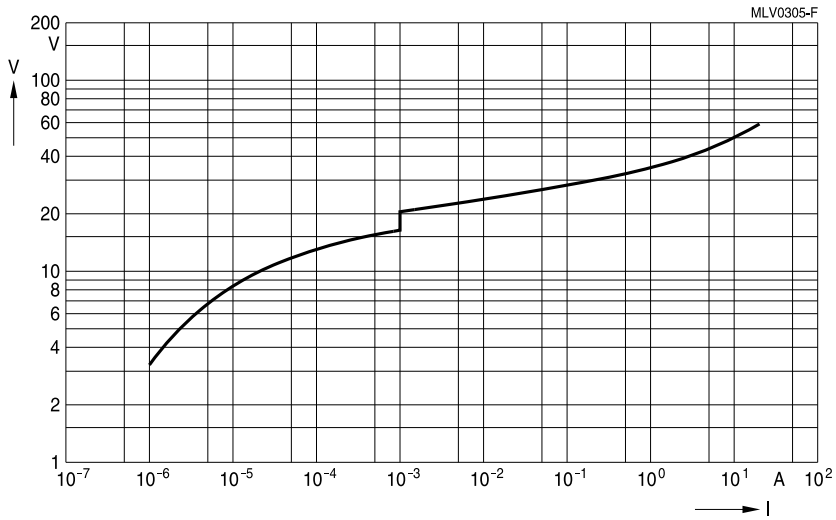

**CT0402S11AG**

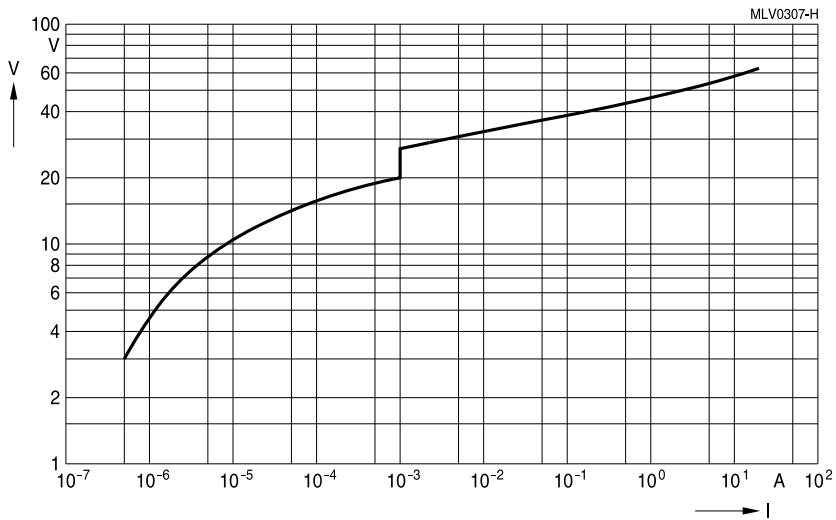

**CT0402L14G**



**Multilayer varistors (MLVs)**

**Standard series**

**SMD**

**V/I characteristics**

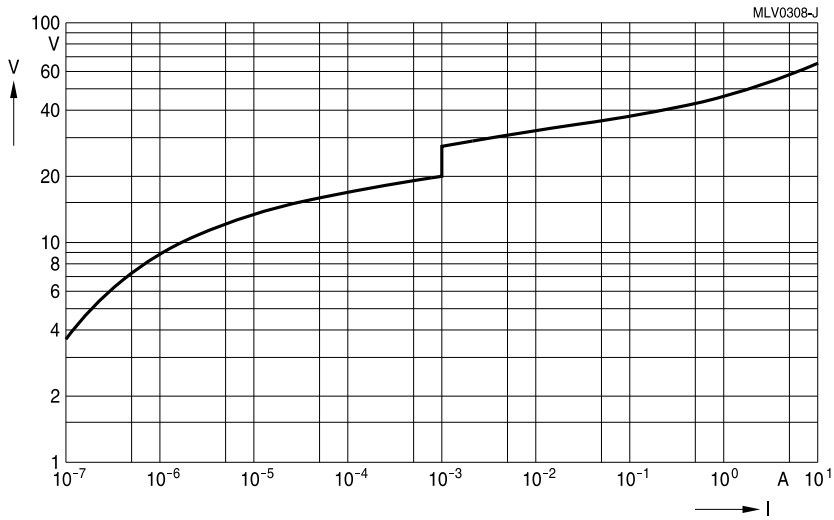

**CT0402L14UG**

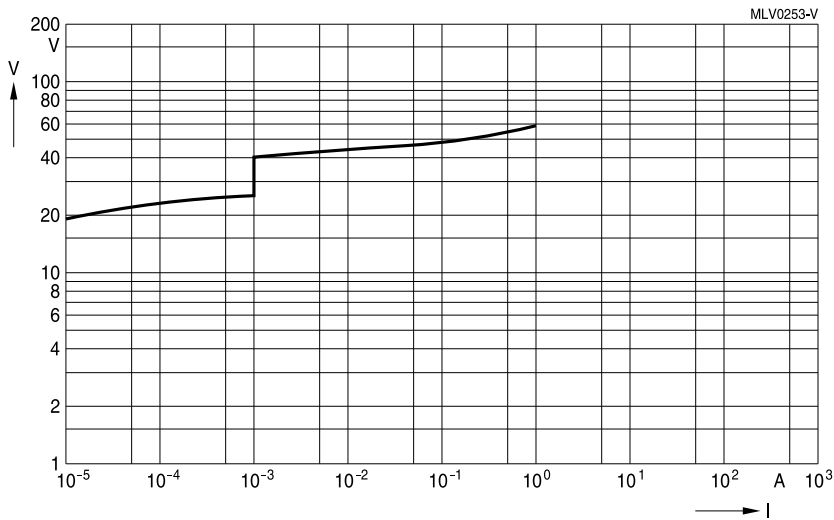

**CT0402S17AG**

**Multilayer varistors (MLVs)**

**Standard series**

**SMD**

**V/I characteristics**

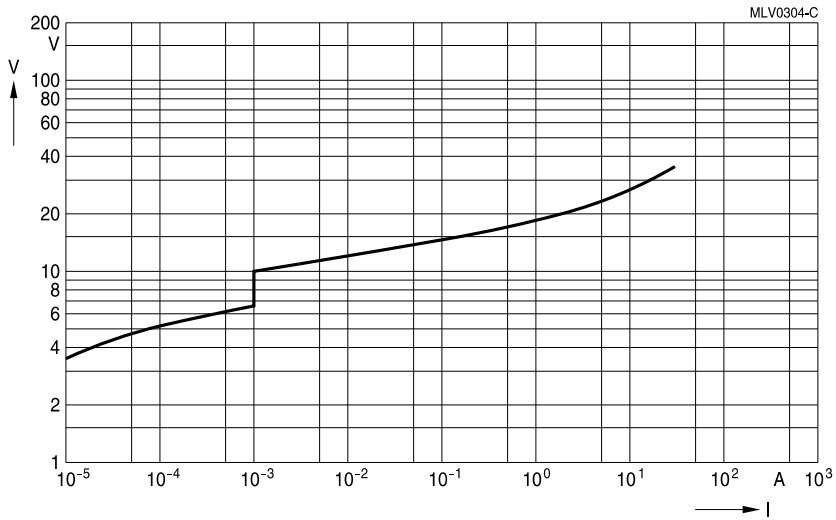

**CT0603M4G**

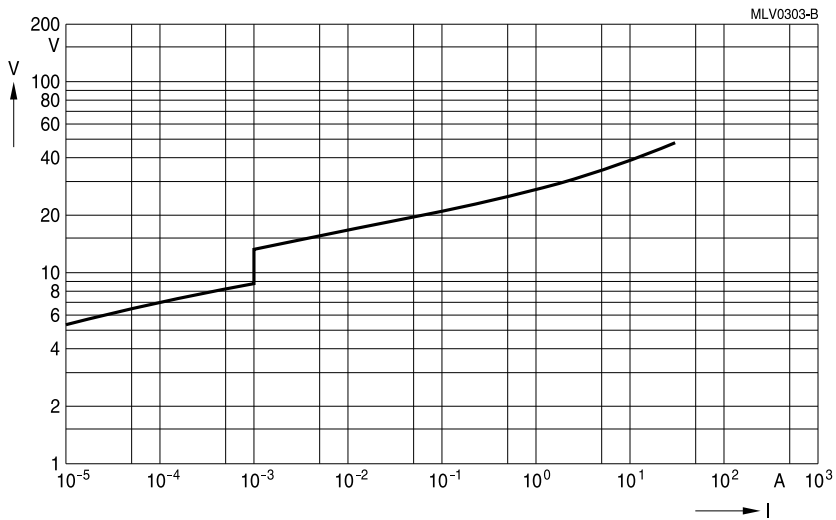

**CT0603M6G**

**Multilayer varistors (MLVs)**

**Standard series**

**SMD**

**V/I characteristics**

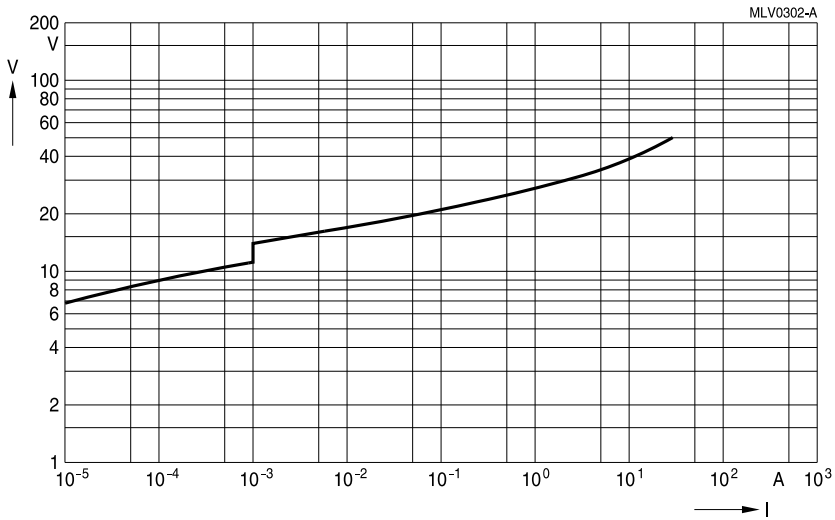

**CT0603K7G**

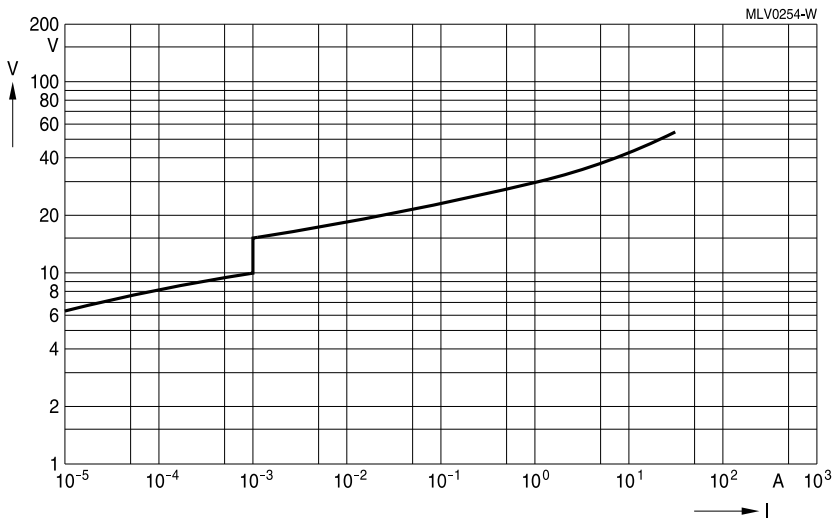

**CT0603M7G**

**Multilayer varistors (MLVs)**

**Standard series**

**SMD**

**V/I characteristics**

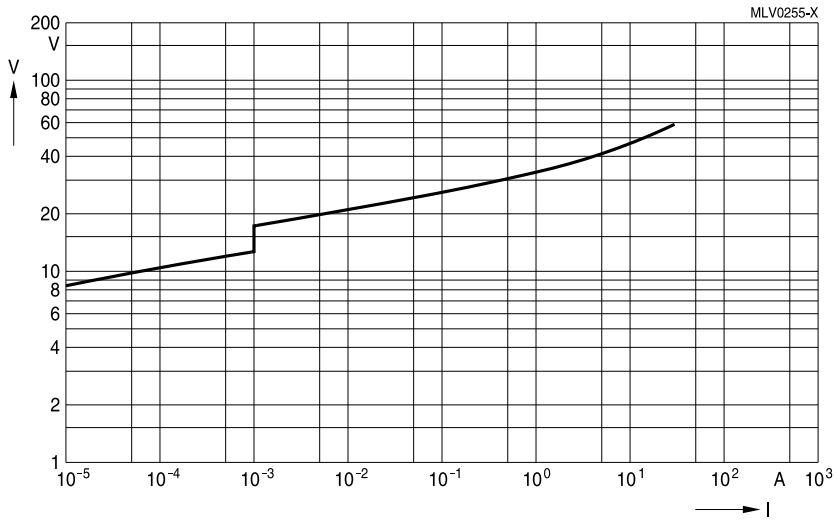

**CT0603L8G**

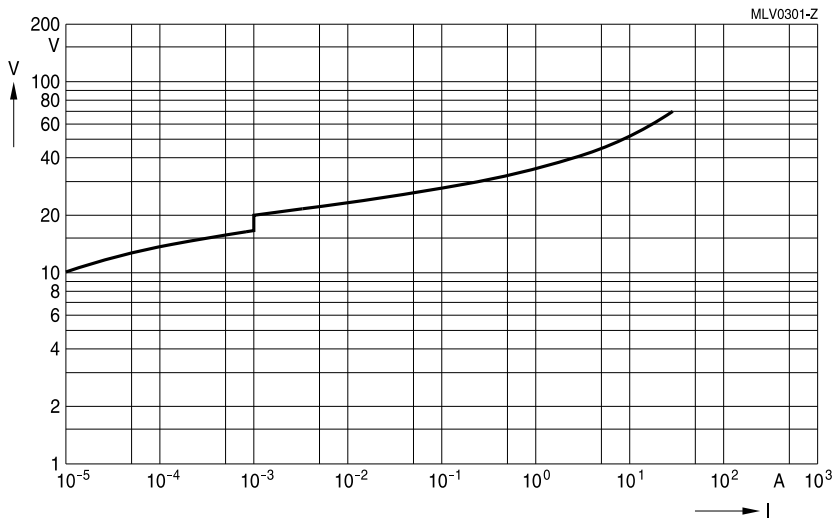

**CT0603K11G**

**Multilayer varistors (MLVs)**

**Standard series**

**SMD**

**V/I characteristics**

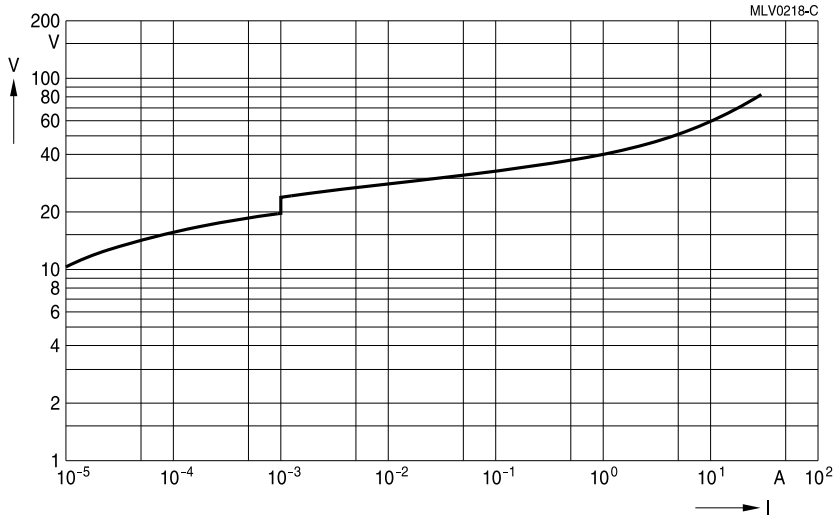

**CT0603K14G**

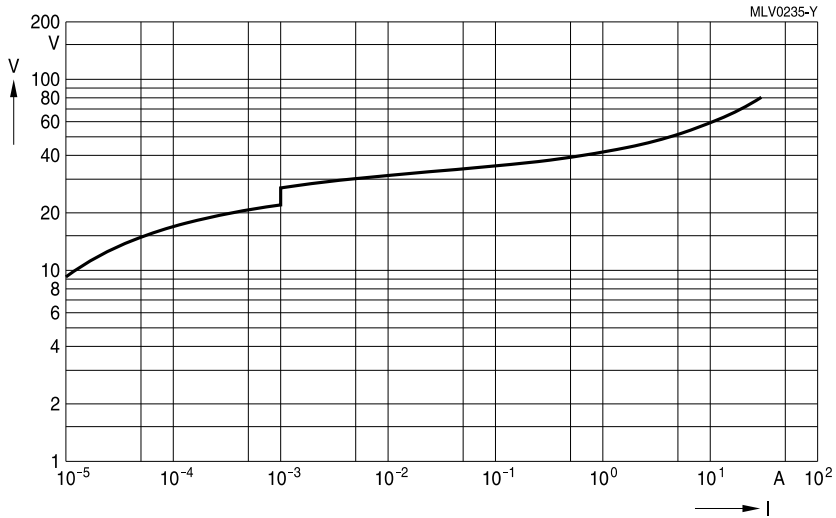

**CT0603S14BG**

**Multilayer varistors (MLVs)**

**Standard series**

**SMD**

**V/I characteristics**

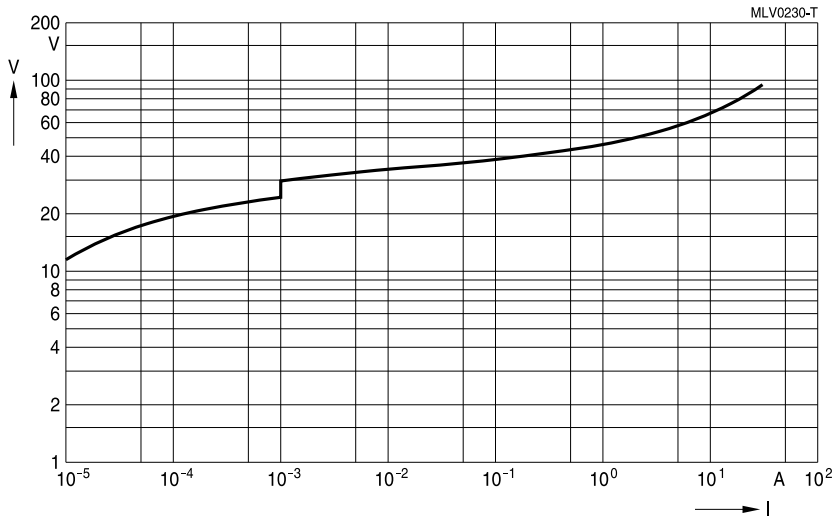

**CT0603K17G**

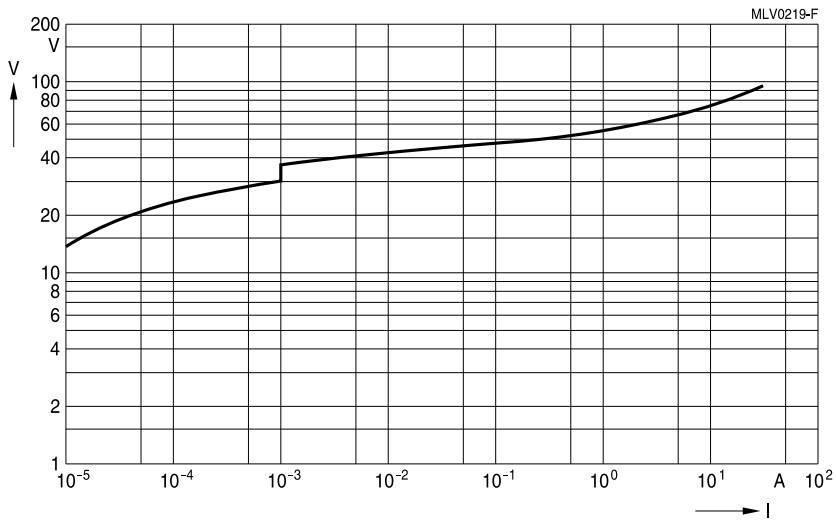

**CT0603K20G**

**Multilayer varistors (MLVs)**

**Standard series**

**SMD**

**V/I characteristics**

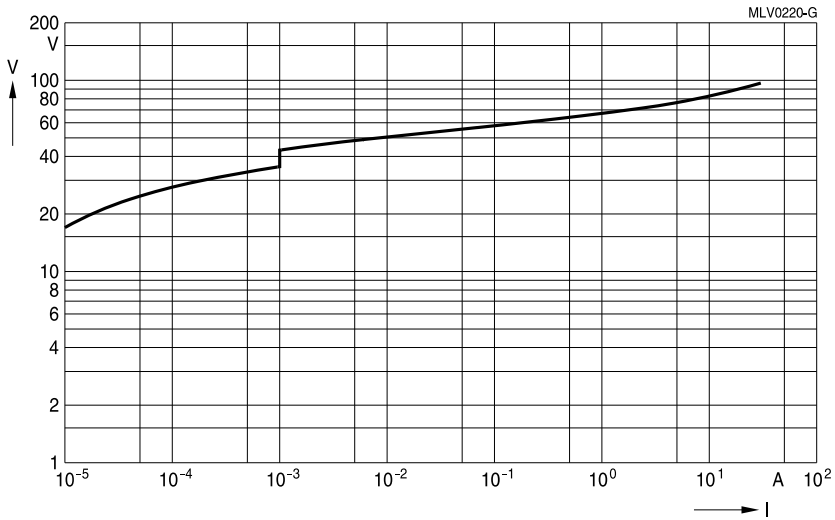

**CT0603K25G**

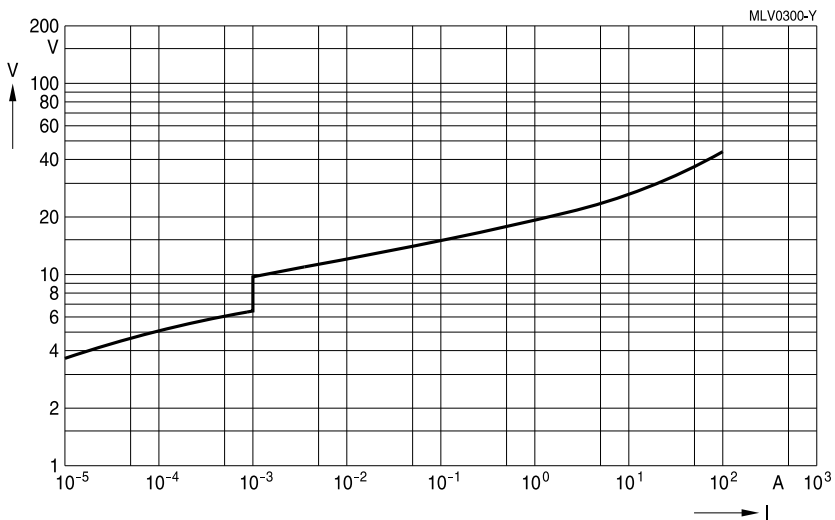

**CT0805M4G**

**Multilayer varistors (MLVs)**

**Standard series**

**SMD**

**V/I characteristics**

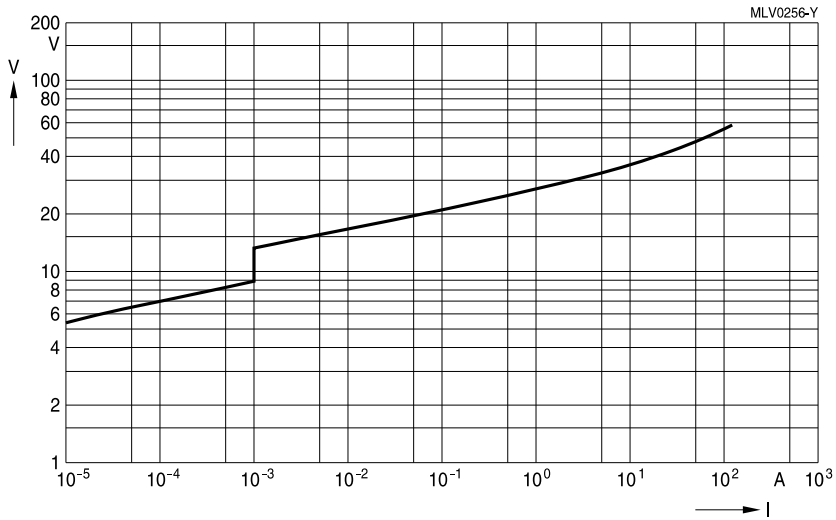

**CT0805M6G**

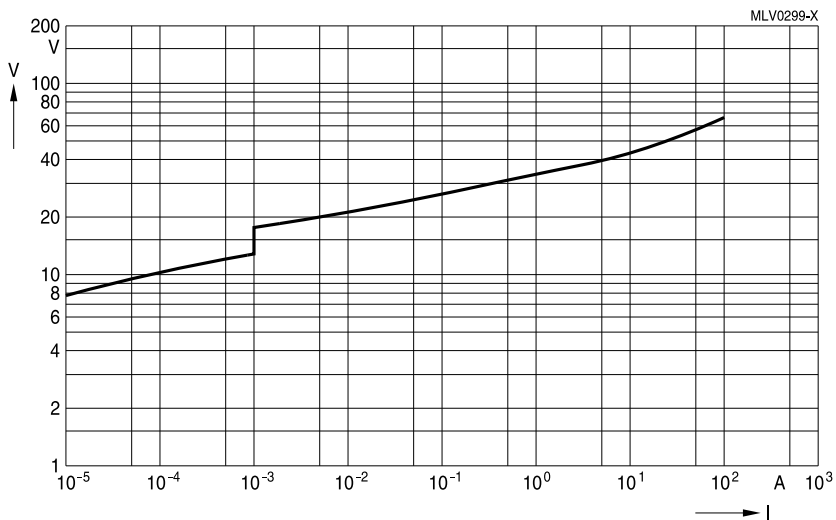

**CT0805L8G**



**Multilayer varistors (MLVs)**

**Standard series**

**SMD**

**V/I characteristics**

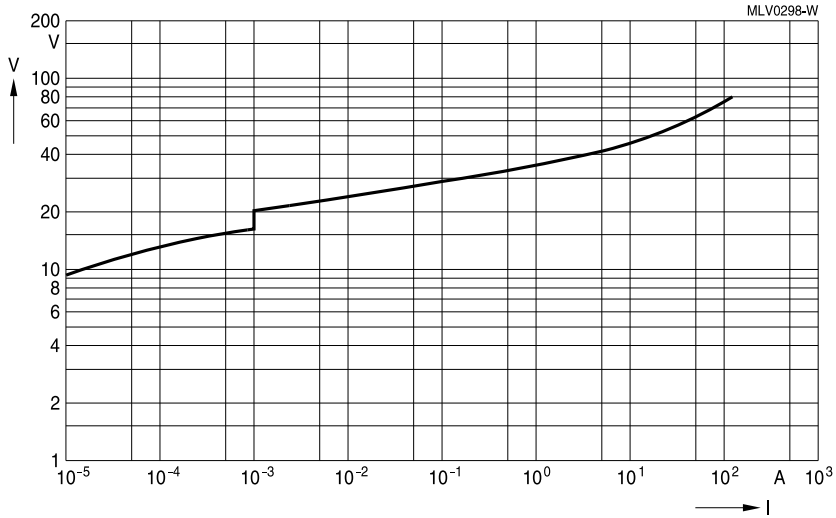

**CT0805K11G**

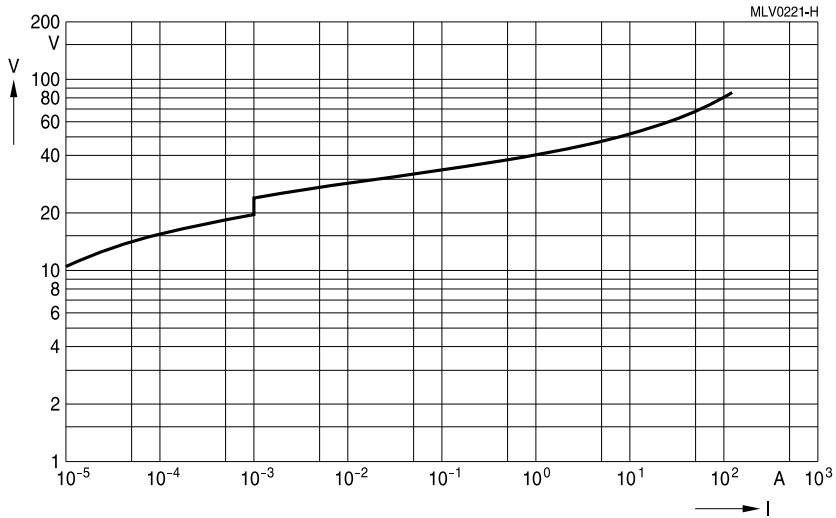

**CT0805K14G**

Multilayer varistors (MLVs)

Standard series

SMD

V/I characteristics

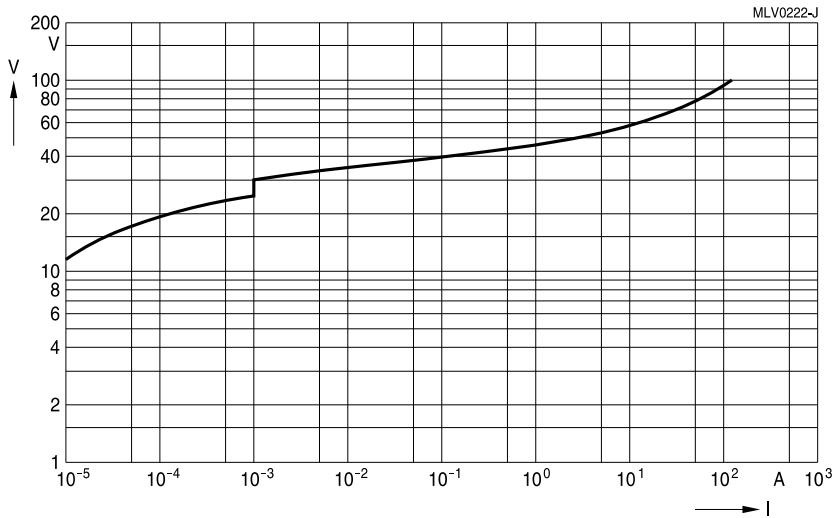

CT0805K17G

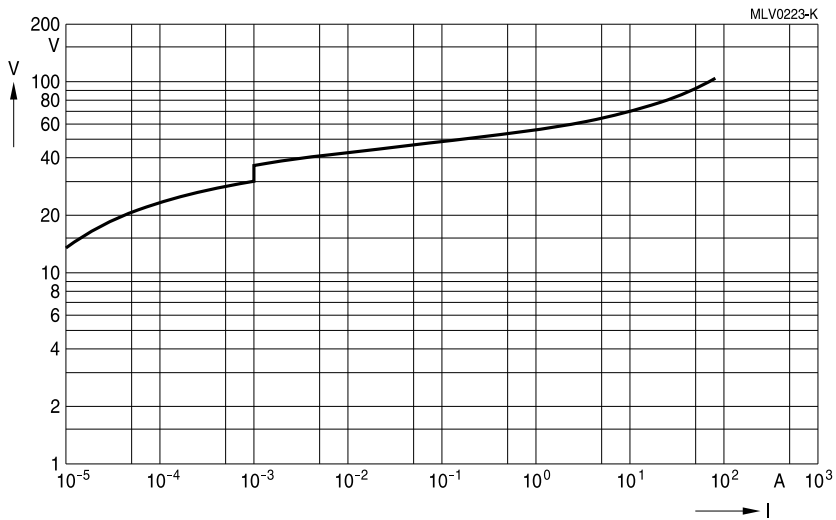

CT0805K20G

**Multilayer varistors (MLVs)**

**Standard series**

**SMD**

**V/I characteristics**

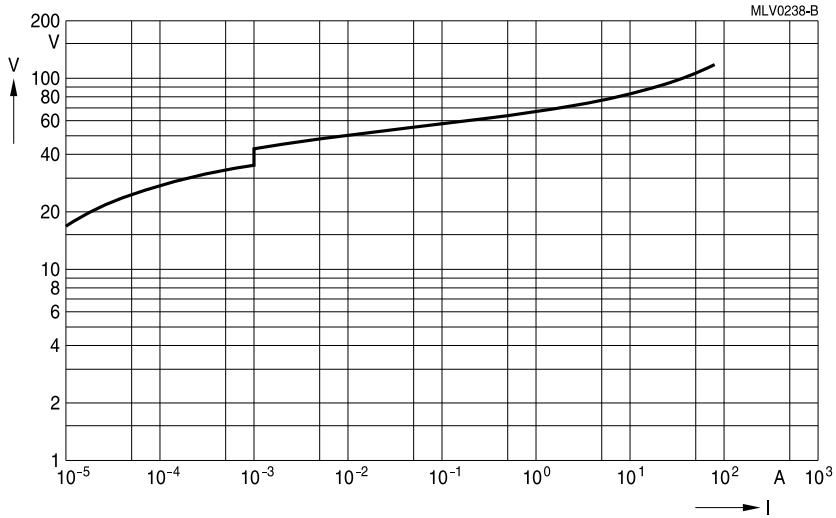

**CT0805K25G**

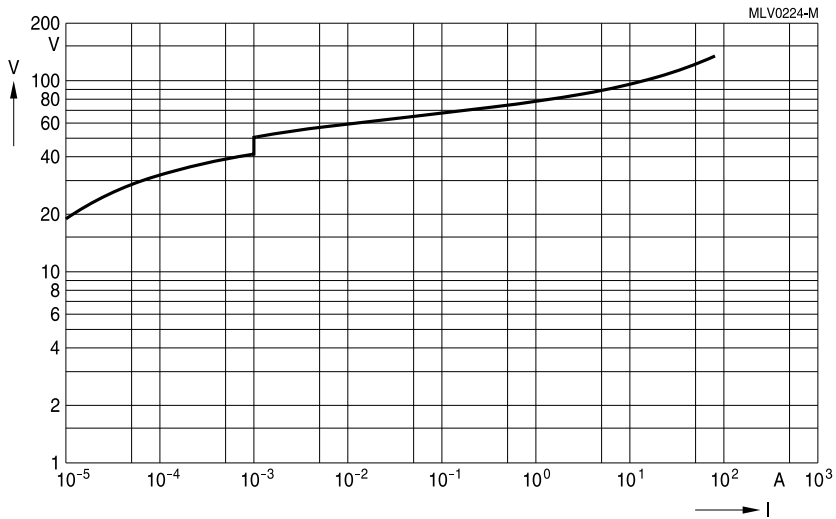

**CT0805K30G**

**Multilayer varistors (MLVs)**

**Standard series**

**SMD**

**V/I characteristics**

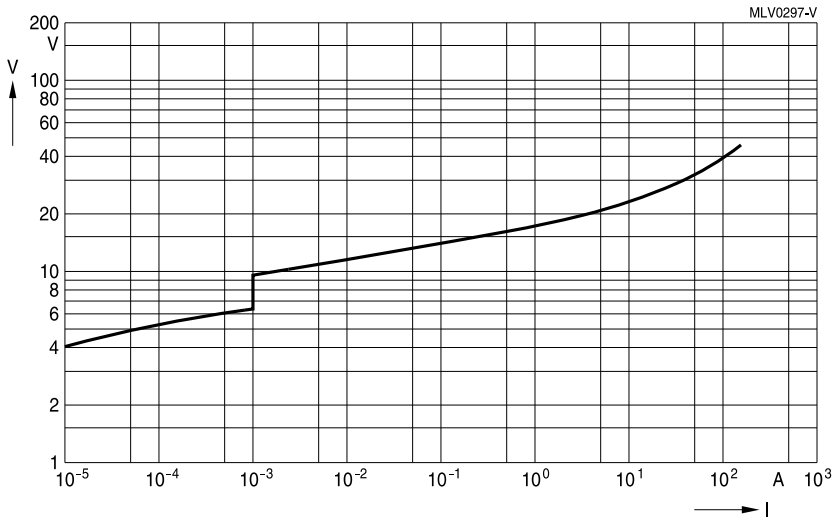

**CT1206M4G**

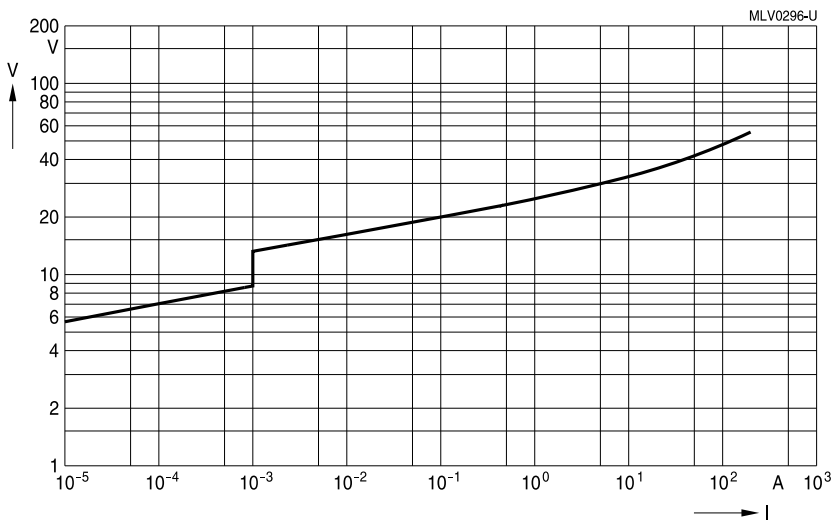

**CT1206M6G**

**Multilayer varistors (MLVs)**

**Standard series**

**SMD**

**V/I characteristics**

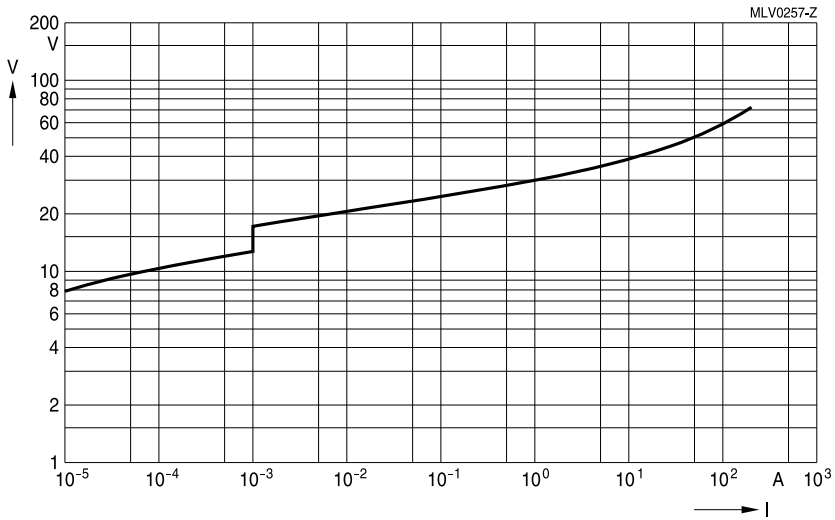

**CT1206L8G**

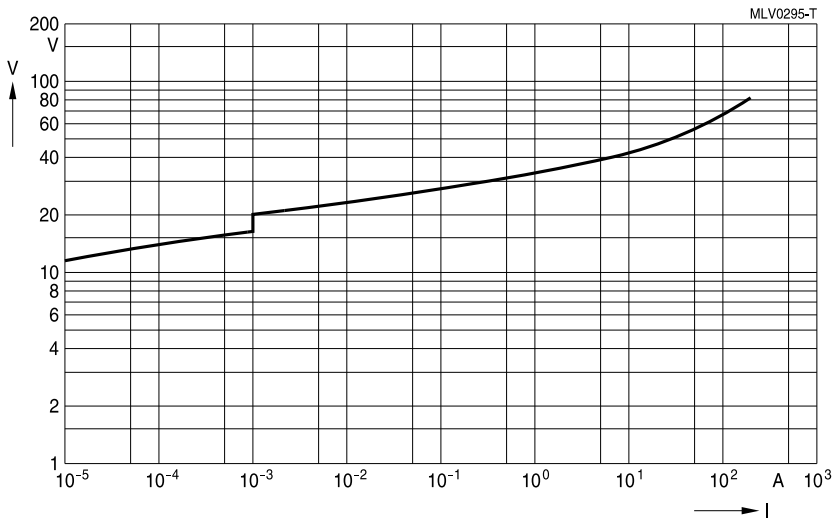

**CT1206K11G**

Multilayer varistors (MLVs)

Standard series

SMD

V/I characteristics

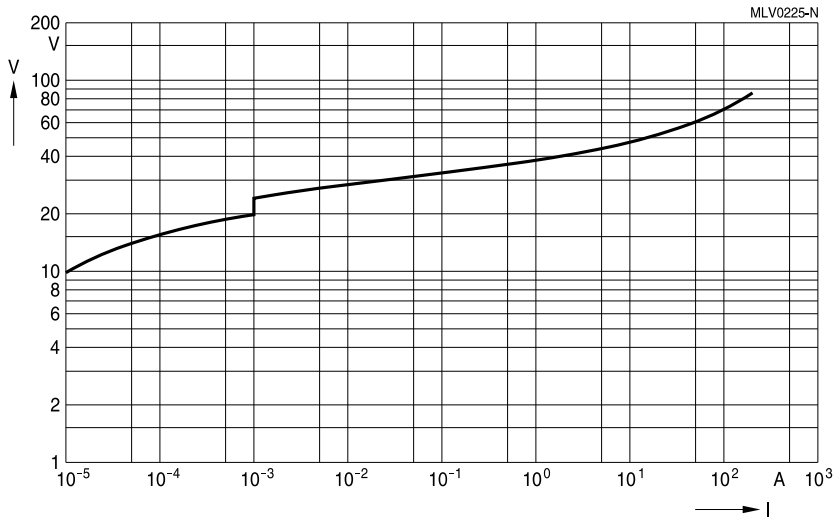

CT1206K14G

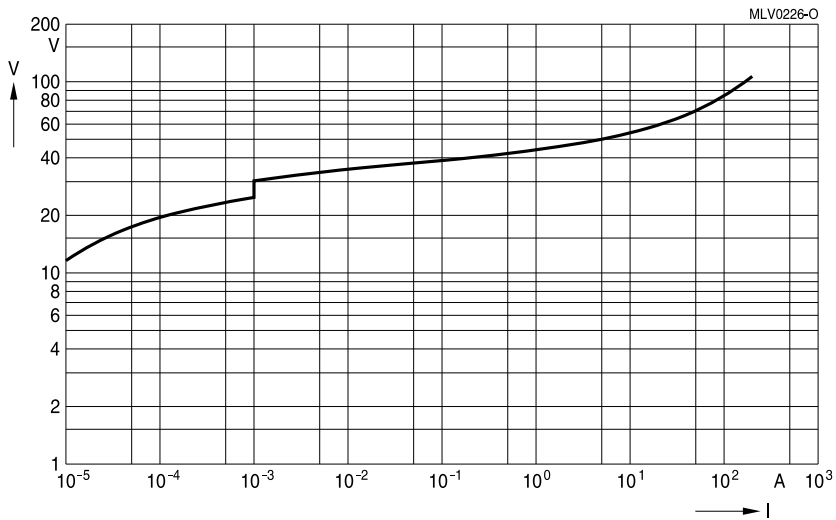

CT1206K17G

Multilayer varistors (MLVs)

Standard series

SMD

V/I characteristics

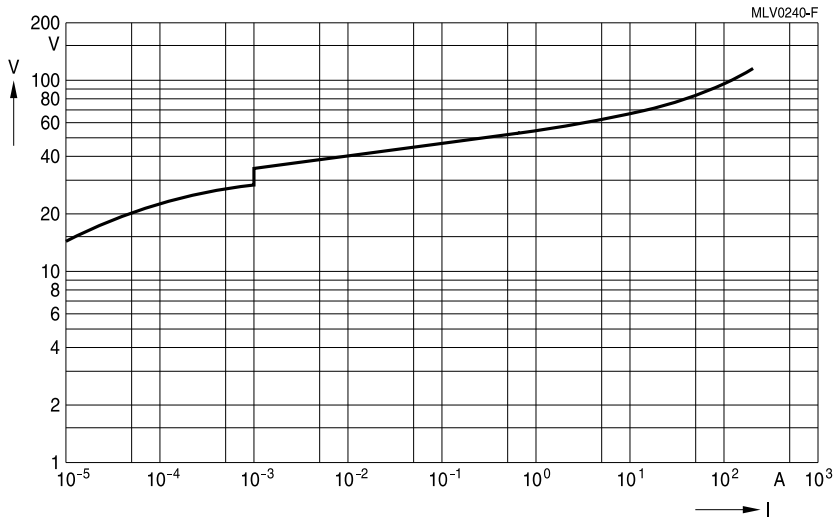

CT1206K20G

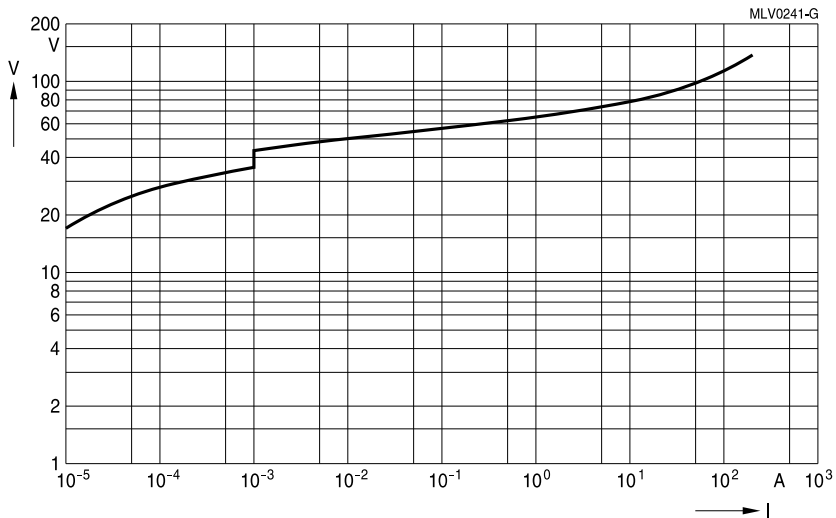

CT1206K25G

**Multilayer varistors (MLVs)**

**Standard series**

**SMD**

**V/I characteristics**

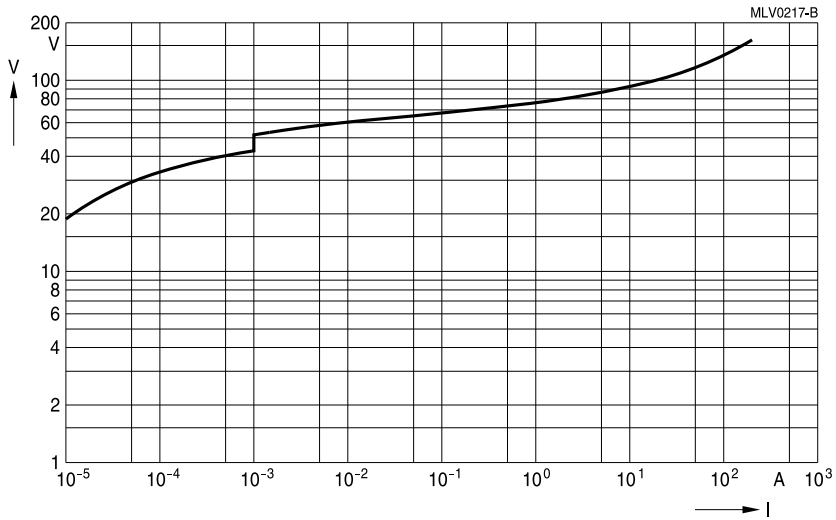

**CT1206K30G**

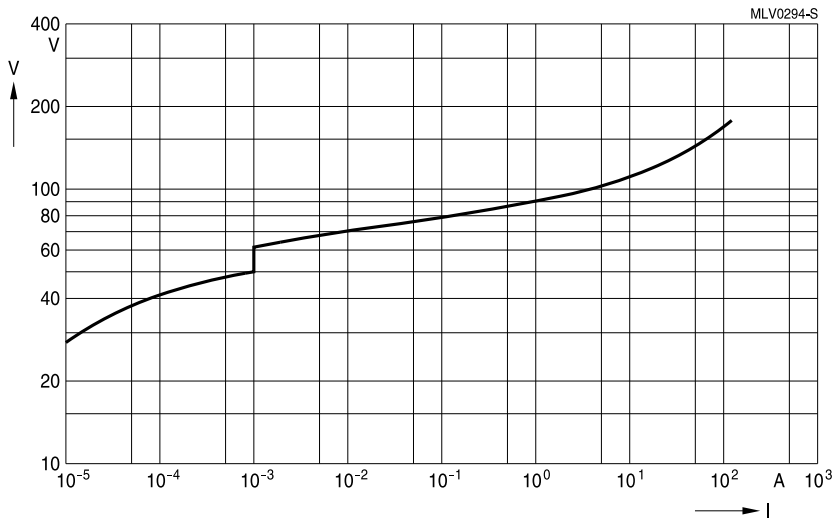

**CT1206K35G**



**Multilayer varistors (MLVs)**

**Standard series**

**SMD**

**V/I characteristics**

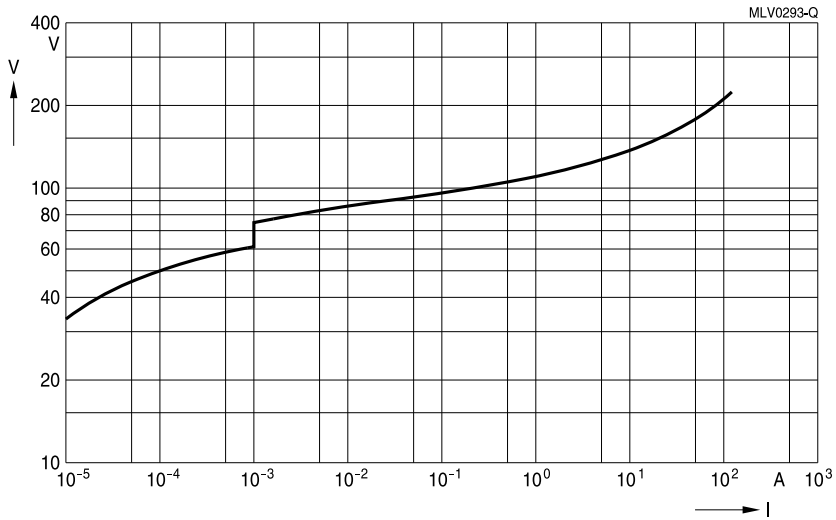

**CT1206K40G**

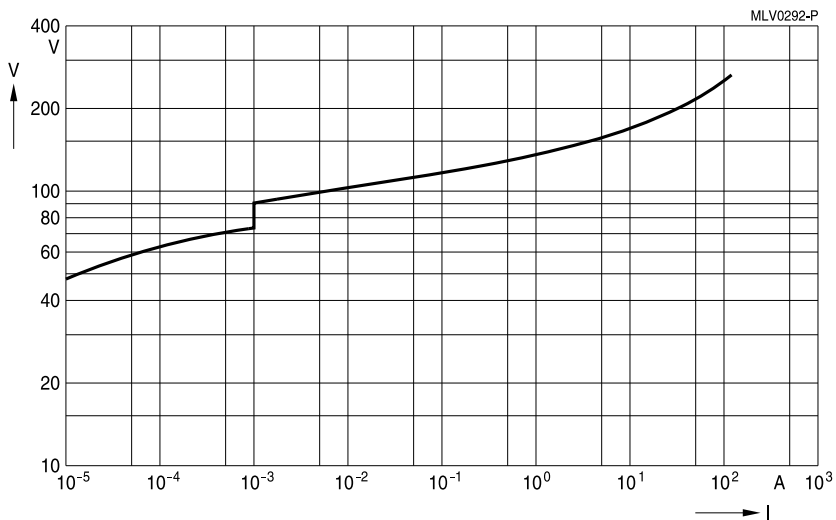

**CT1206K50G**

**Multilayer varistors (MLVs)**

**Standard series**

**SMD**

**V/I characteristics**

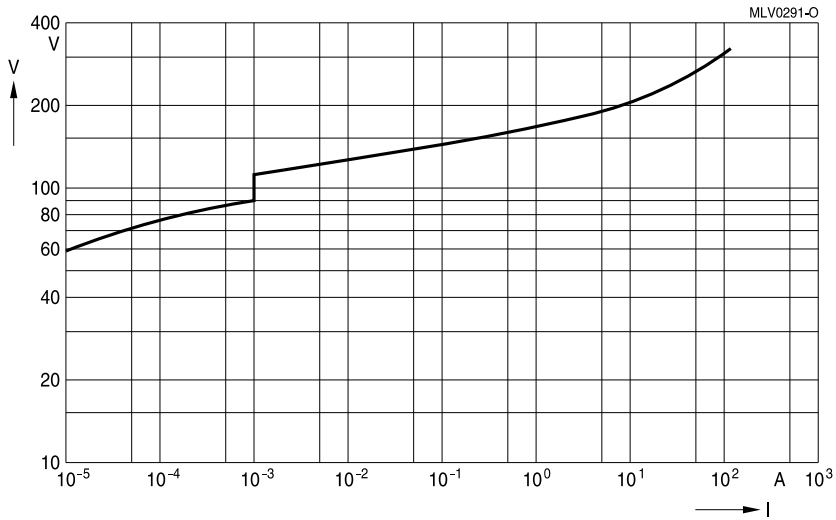

**CT1206K60G**

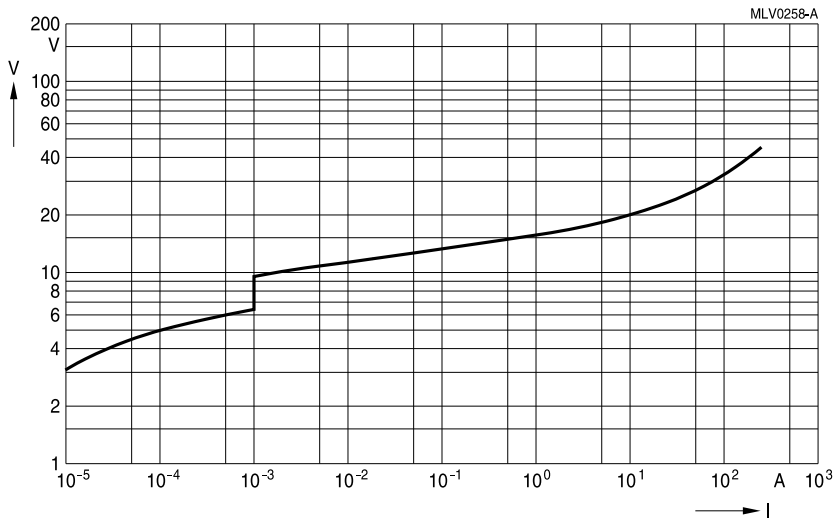

**CT1210M4**

**Multilayer varistors (MLVs)**

**Standard series**

**SMD**

**V/I characteristics**

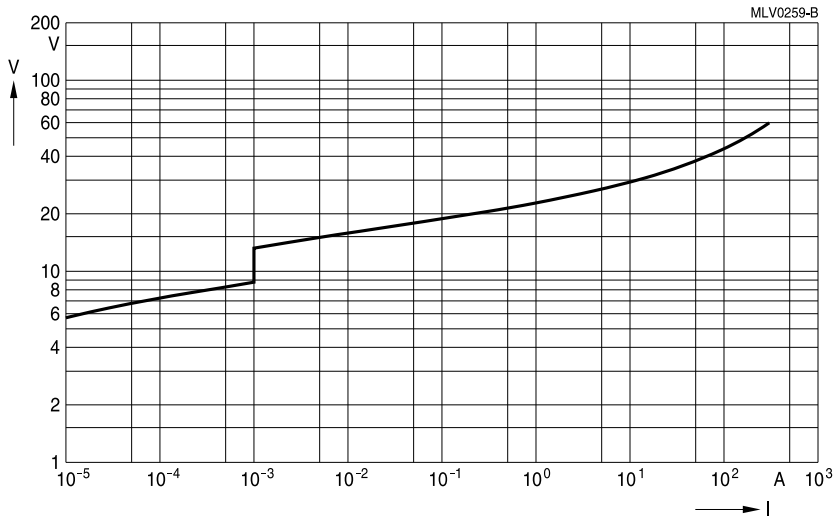

**CT1210M6G**

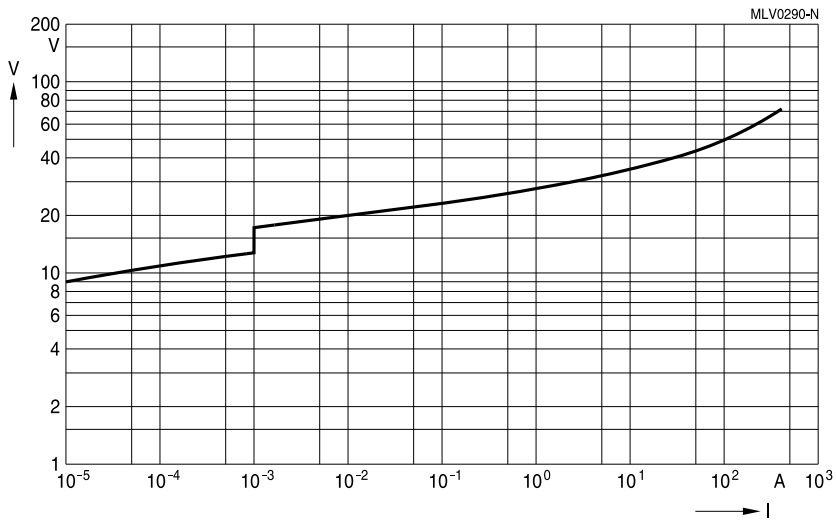

**CT1210L8G**

**Multilayer varistors (MLVs)**

**Standard series**

**SMD**

**V/I characteristics**

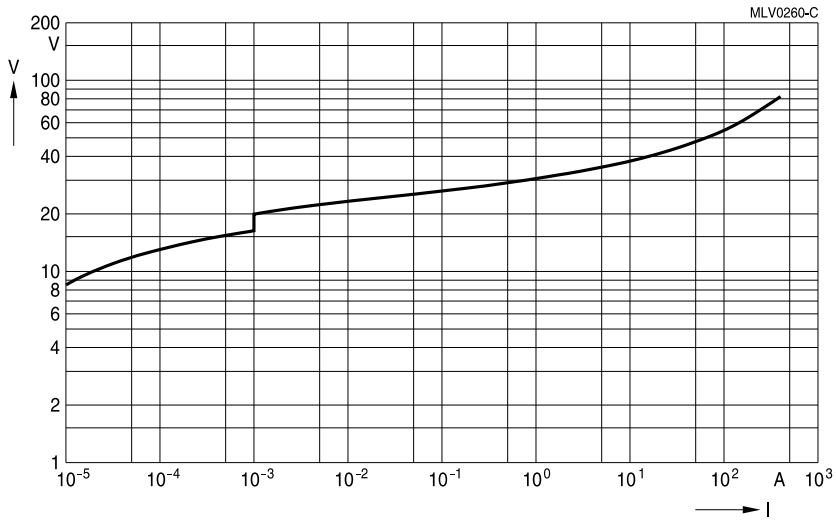

**CT1210K11G**

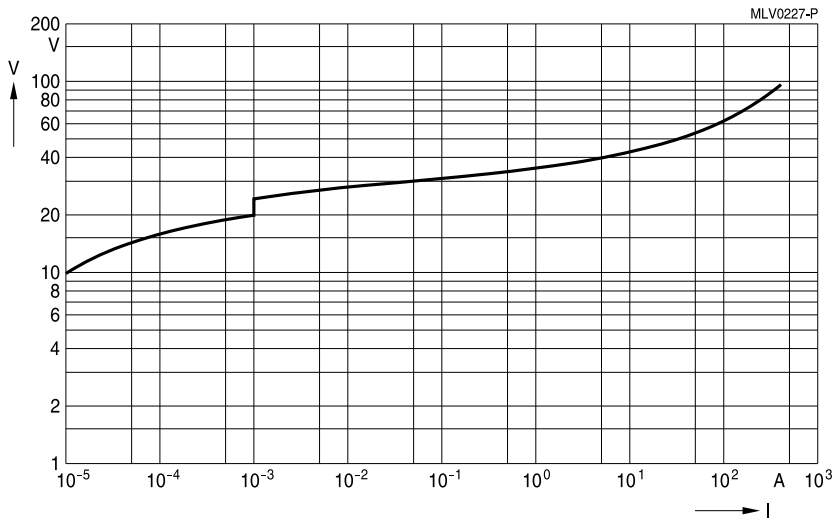

**CT1210K14G**

**Multilayer varistors (MLVs)**

**Standard series**

**SMD**

**V/I characteristics**

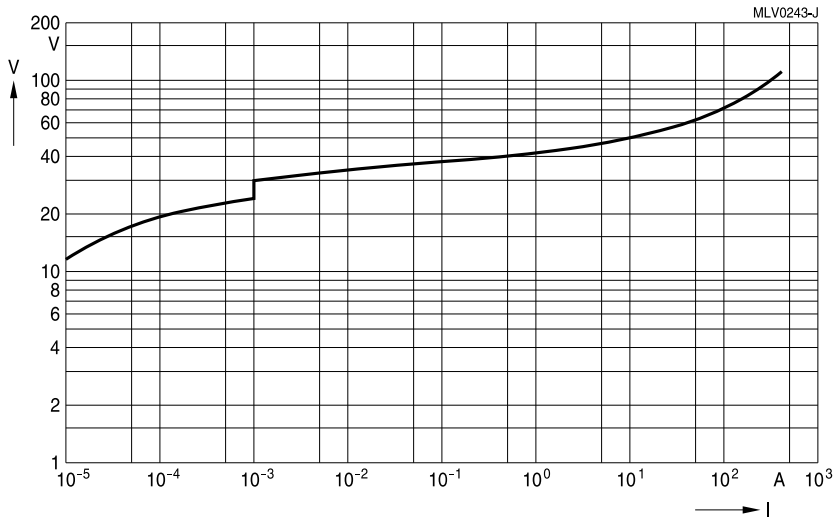

**CT1210K17G**

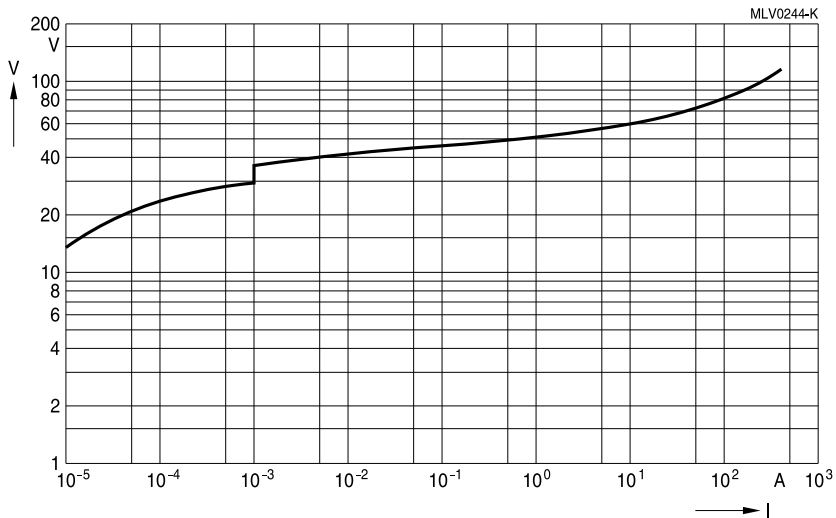

**CT1210K20G**

**Multilayer varistors (MLVs)**

**Standard series**

**SMD**

**V/I characteristics**

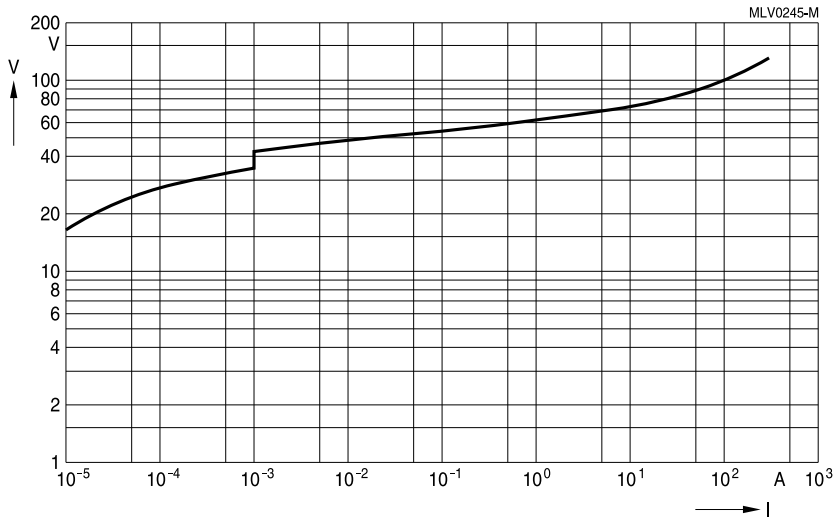

**CT1210K25G**

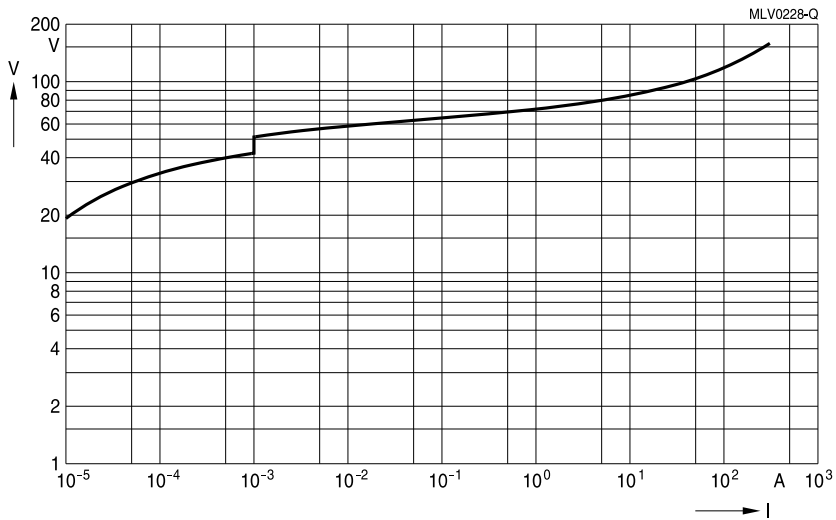

**CT1210K30G**

Multilayer varistors (MLVs)

Standard series

SMD

V/I characteristics

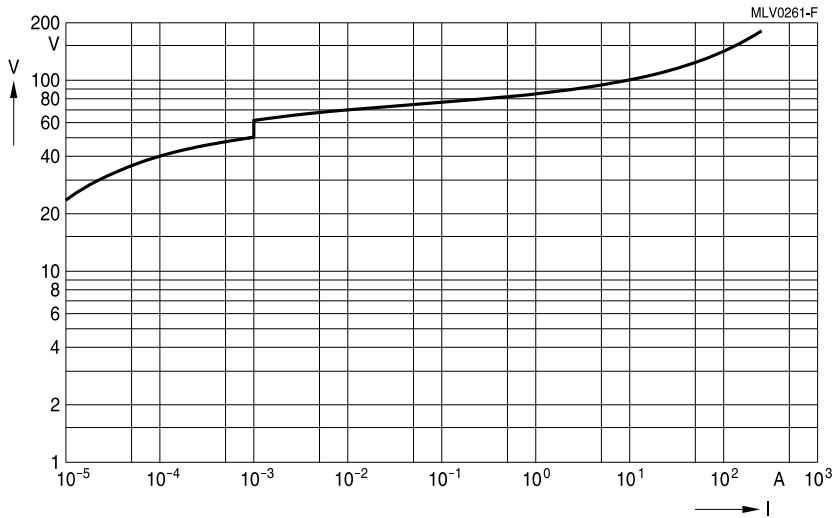

CT1210K35G

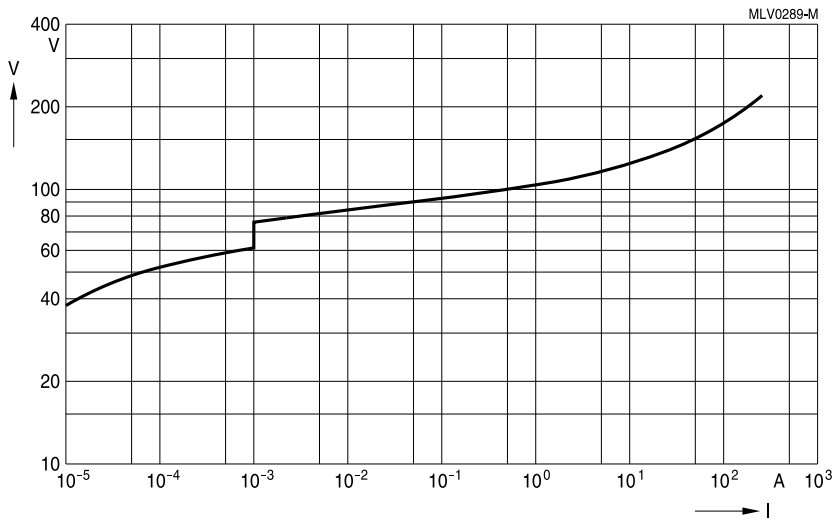

CT1210K40G

**Multilayer varistors (MLVs)**

**Standard series**

**SMD**

**V/I characteristics**

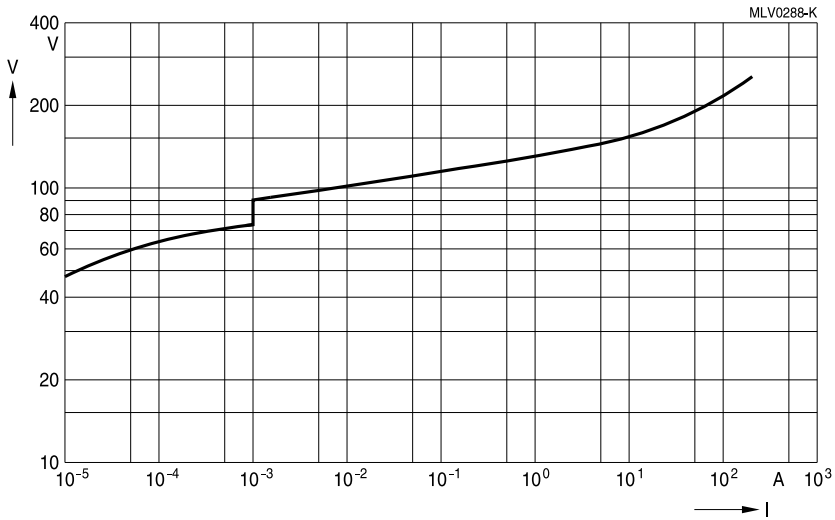

**CT1210K50G**

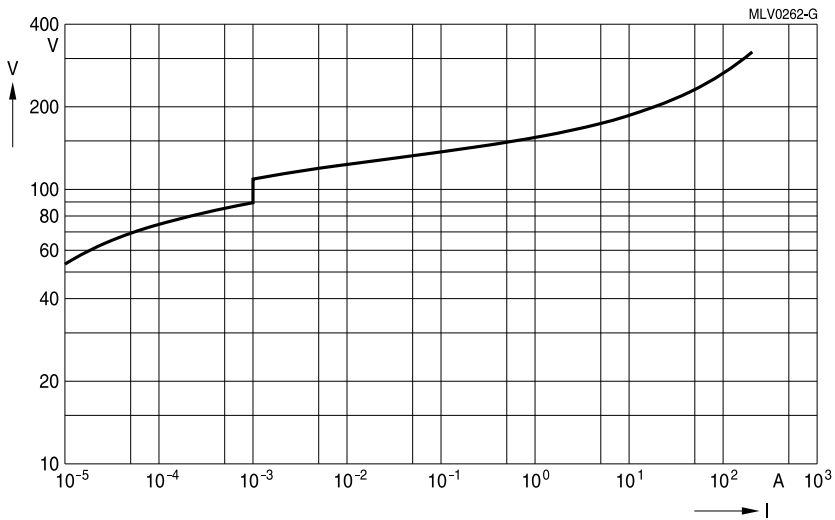

**CT1210K60G**



**Multilayer varistors (MLVs)**

**Standard series**

**SMD**

**V/I characteristics**

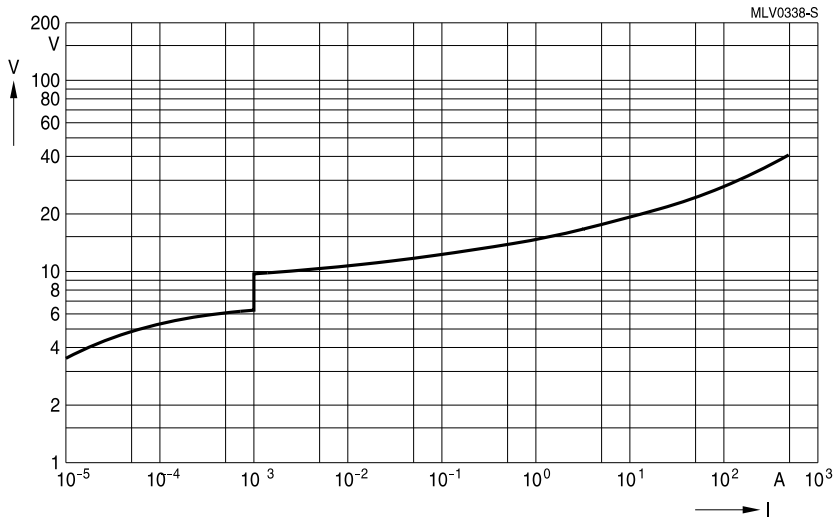

**CN1812M4G**

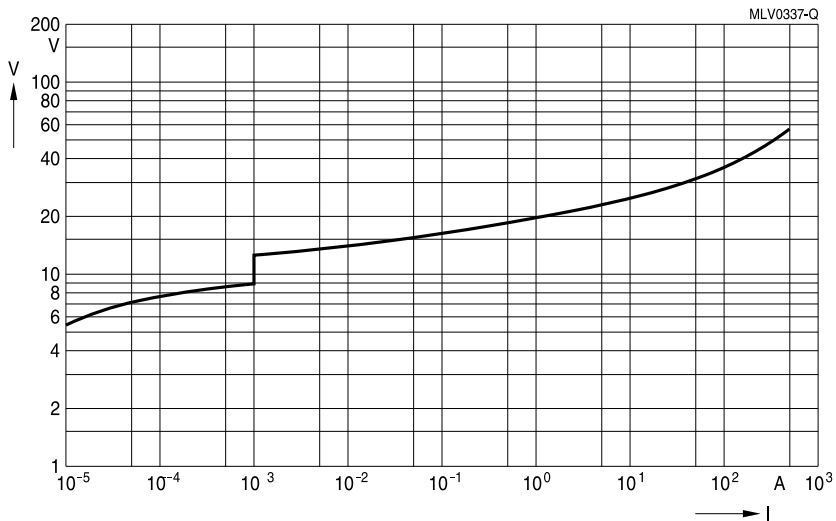

**CN1812M6G**

Multilayer varistors (MLVs)

Standard series

SMD

V/I characteristics

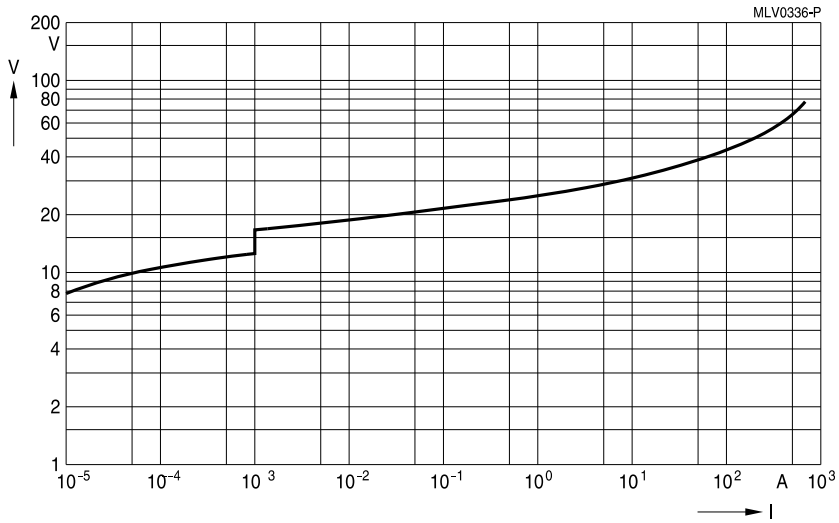

CN1812L8G

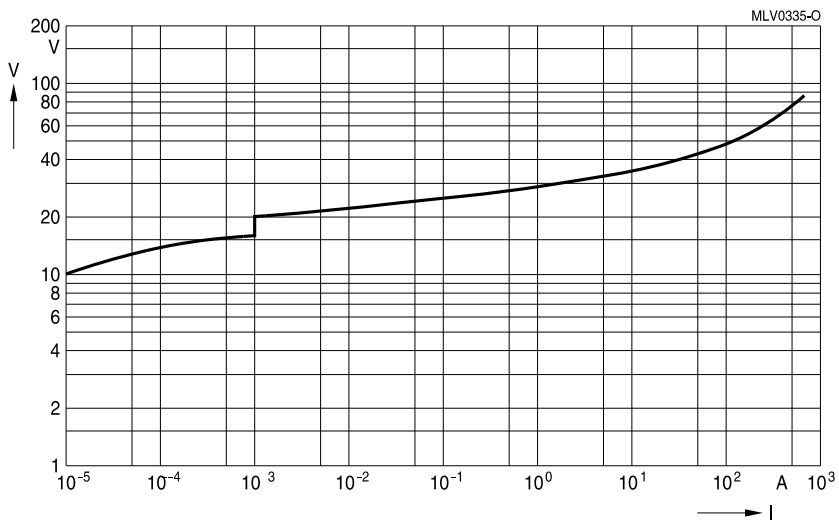

CN1812K11G

Multilayer varistors (MLVs)

Standard series

SMD

V/I characteristics

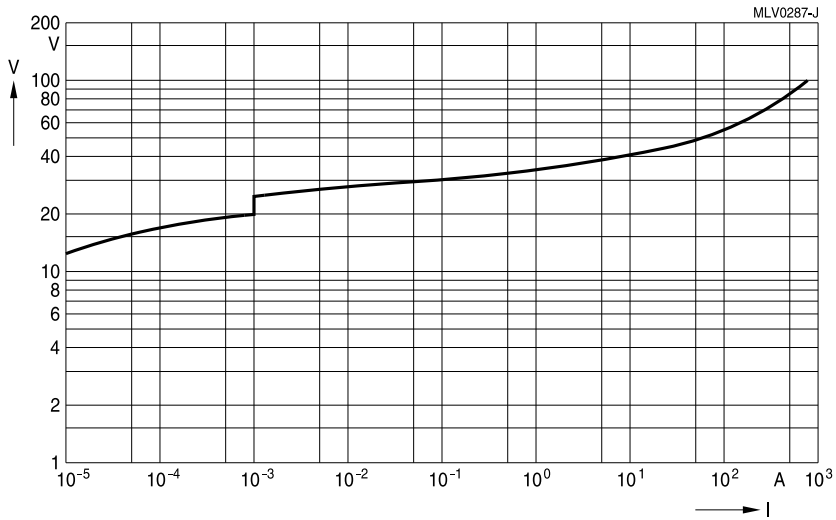

CN1812K14G(K2)

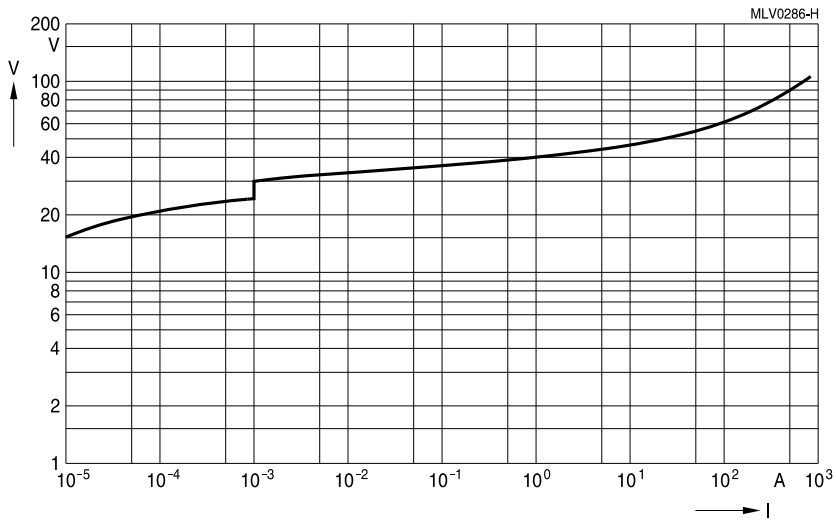

CN1812K17G

**Multilayer varistors (MLVs)**

**Standard series**

**SMD**

**V/I characteristics**

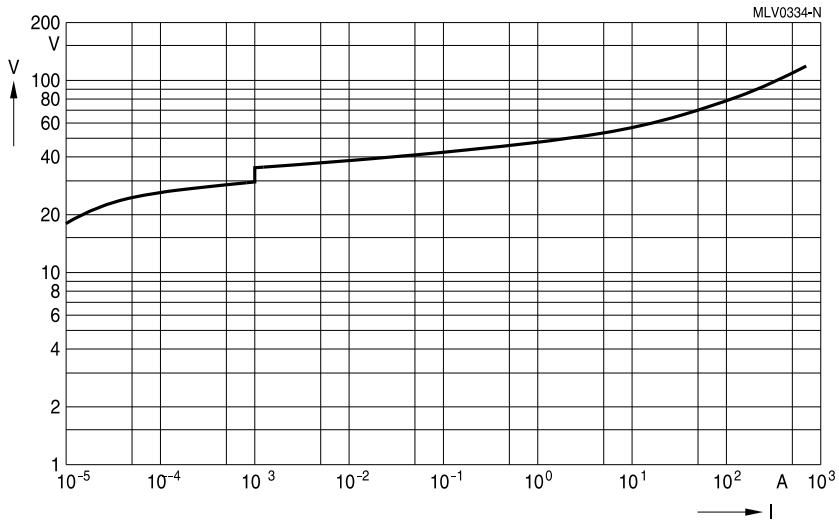

**CN1812K20G**

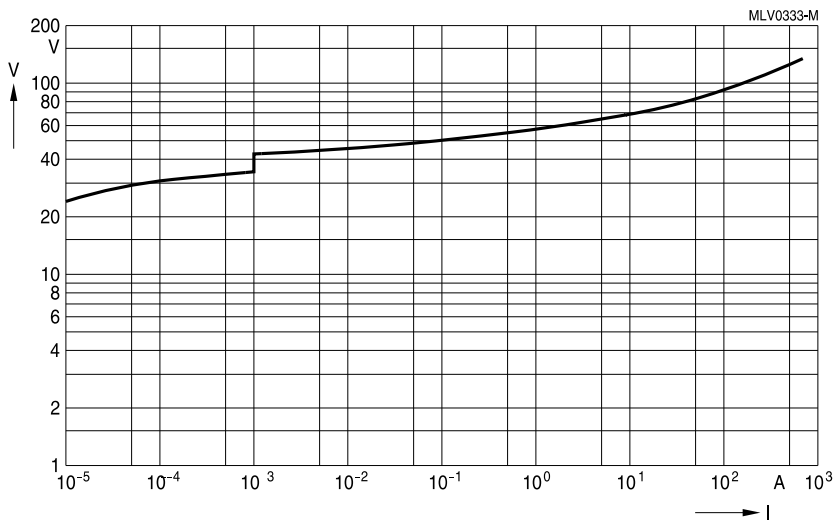

**CN1812K25G**

**Multilayer varistors (MLVs)**

**Standard series**

**SMD**

**V/I characteristics**

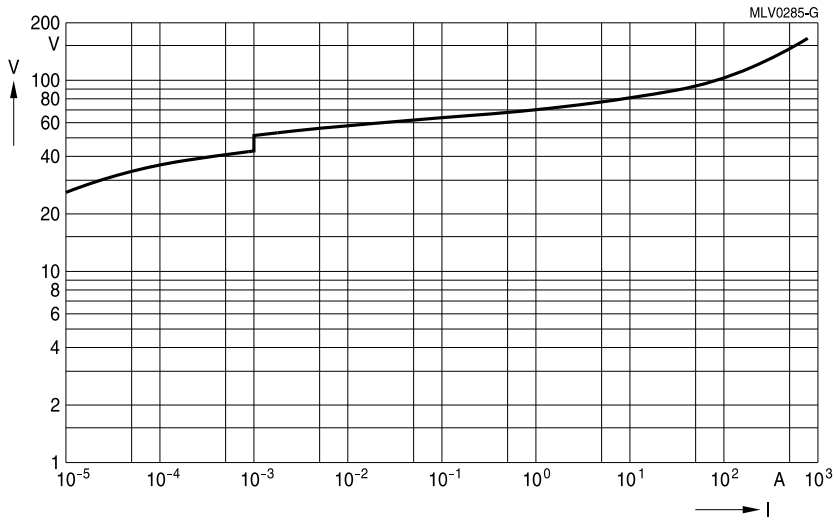

**CN1812K30G(K2)**

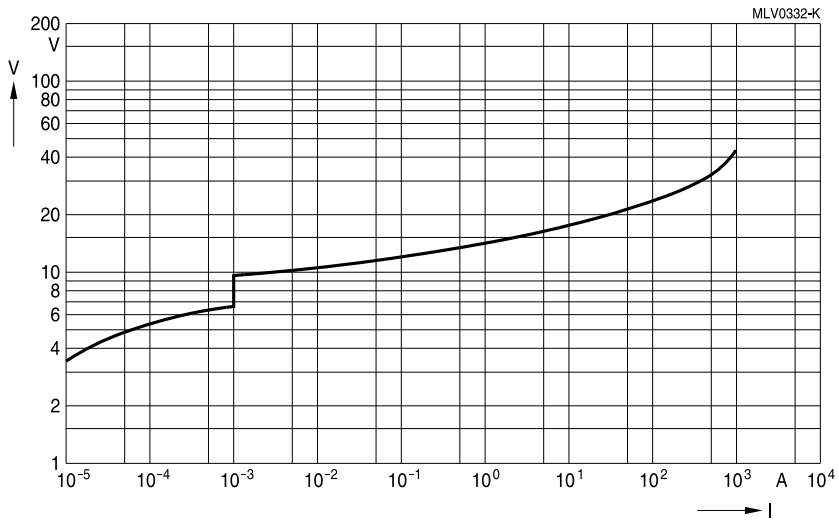

**CN2220M4G**

**Multilayer varistors (MLVs)**

**Standard series**

**SMD**

**V/I characteristics**

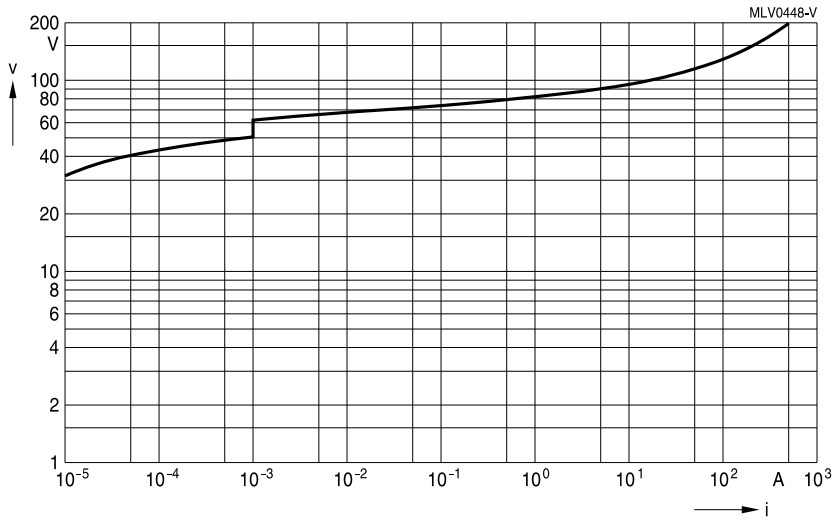

**CN1812K35GK2**

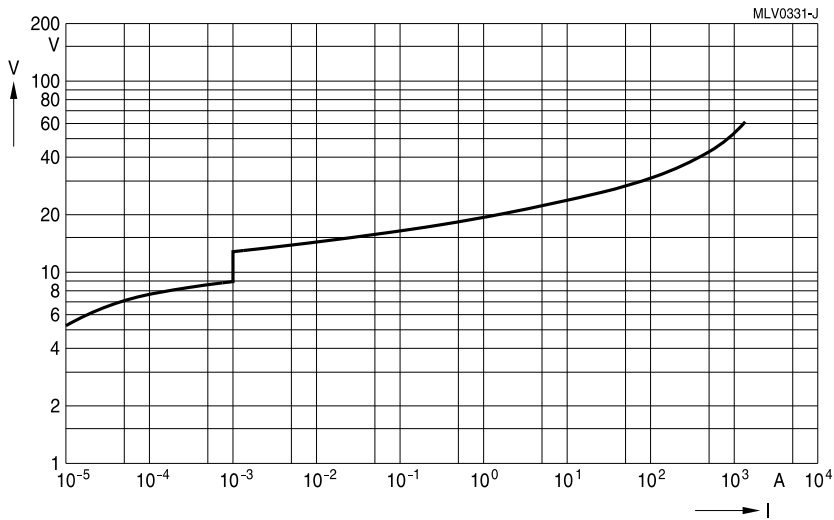

**CN2220M6G**

**Multilayer varistors (MLVs)**

**Standard series**

**SMD**

**V/I characteristics**

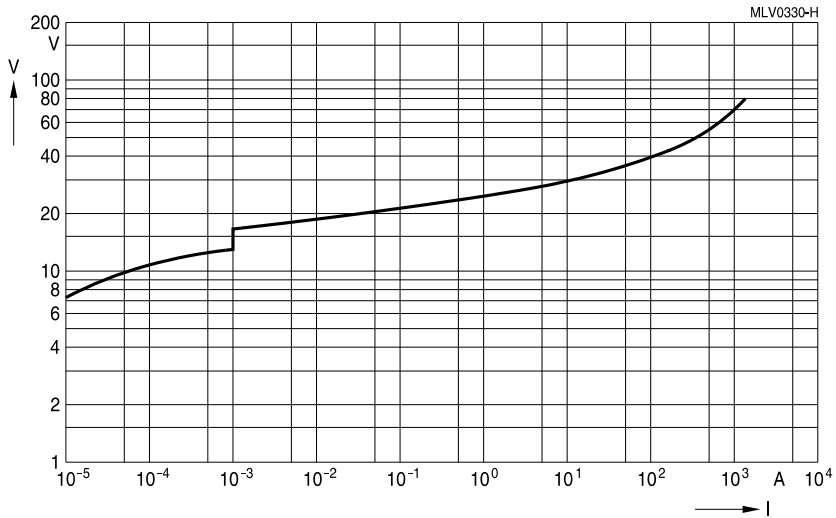

**CN2220L8G**

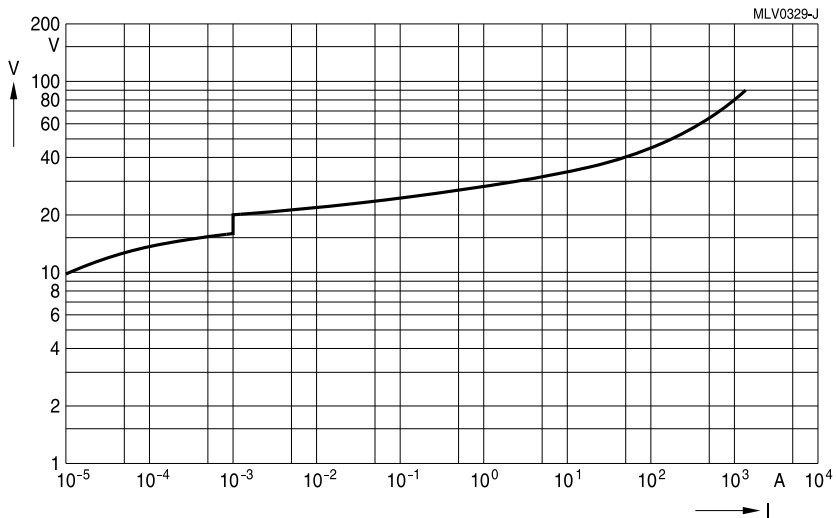

**CN2220K11G**

**Multilayer varistors (MLVs)**

**Standard series**

**SMD**

**V/I characteristics**

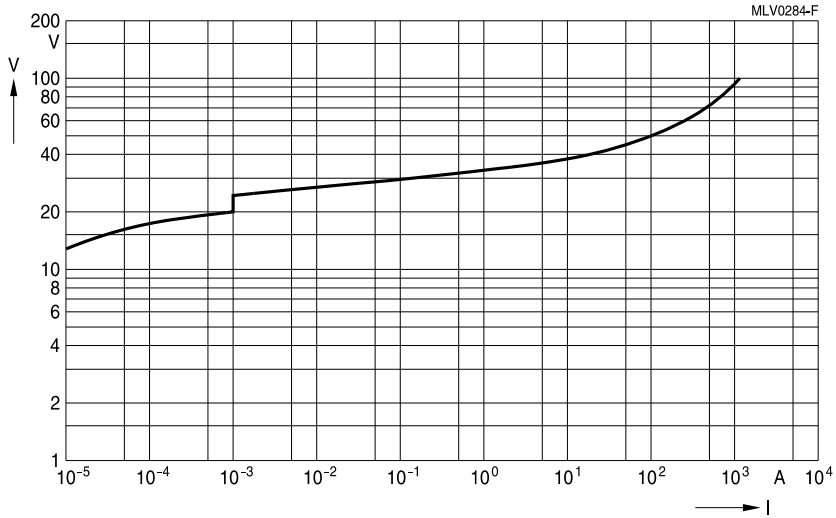

**CN2220K14G**

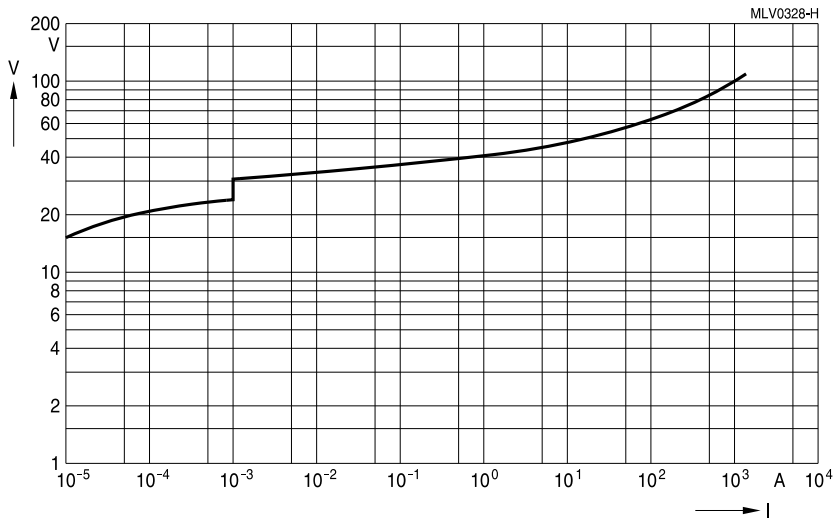

**CN2220K17G**



**Multilayer varistors (MLVs)**

**Standard series**

**SMD**

**V/I characteristics**

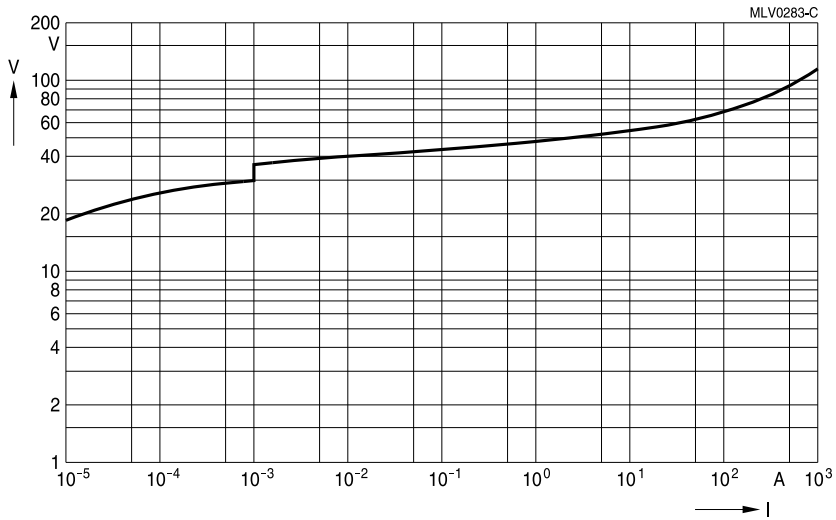

**CN2220K20G(K2)**

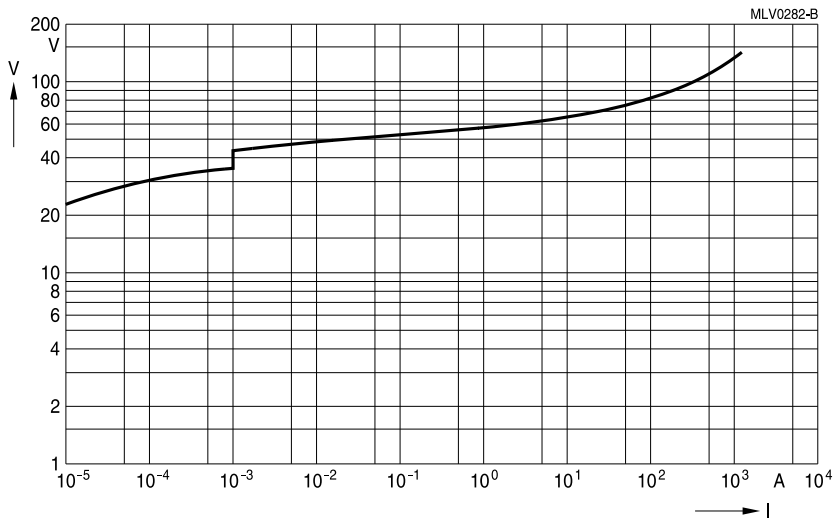

**CN2220K25G(K2)**

**Multilayer varistors (MLVs)**

**Standard series**

**SMD**

**V/I characteristics**

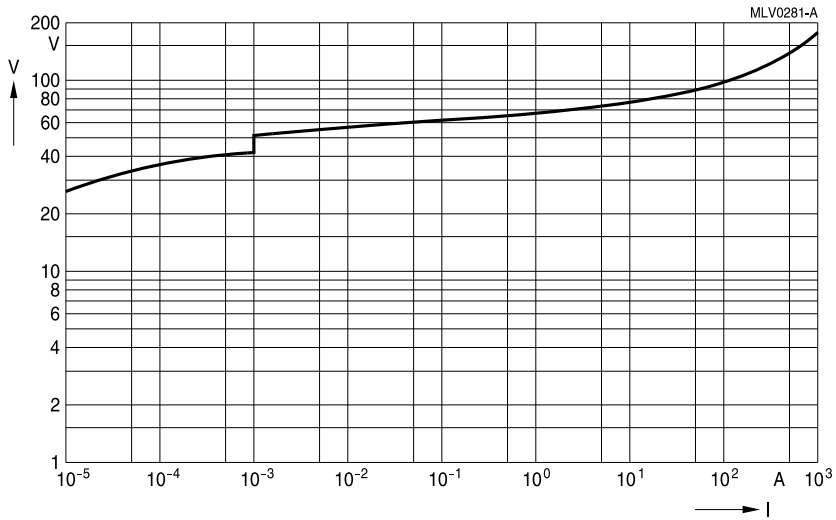

**CN2220K30G(K2)**

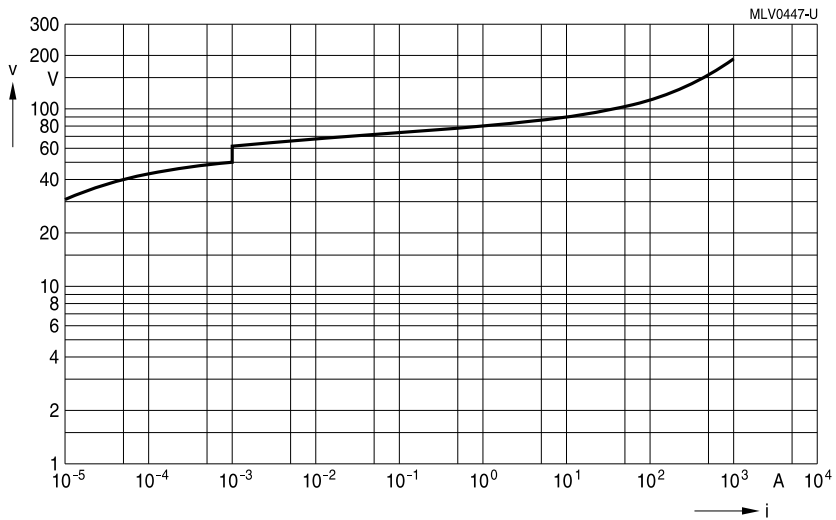

**CN2220K35GK2**

**Multilayer varistors (MLVs)**

**Standard series**

**SMD**

**V/I characteristics**

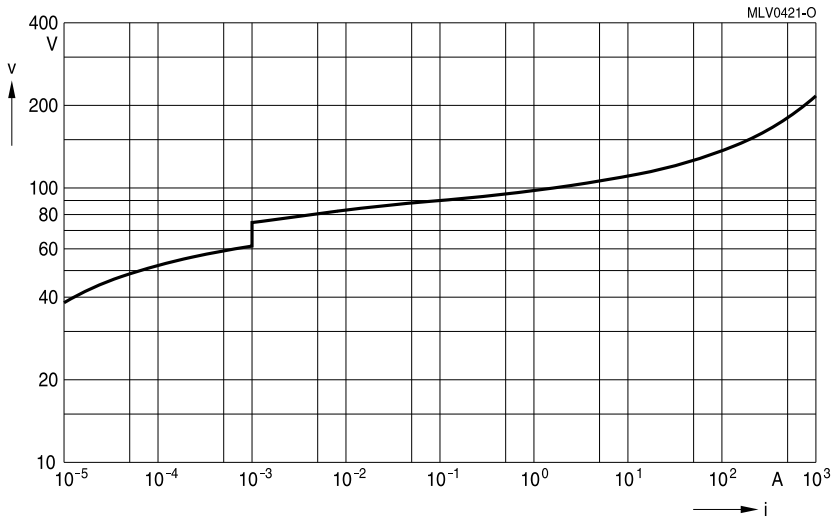

CN2220K40GK2

**Multilayer varistors (MLVs)**

**Standard series**

**SMD**

**Derating curves**

Maximum surge current  $I_{\text{surge,max}} = f(t_r, \text{pulse train})$

For explanation of the derating curves refer to "General technical information", chapter 2.7.2

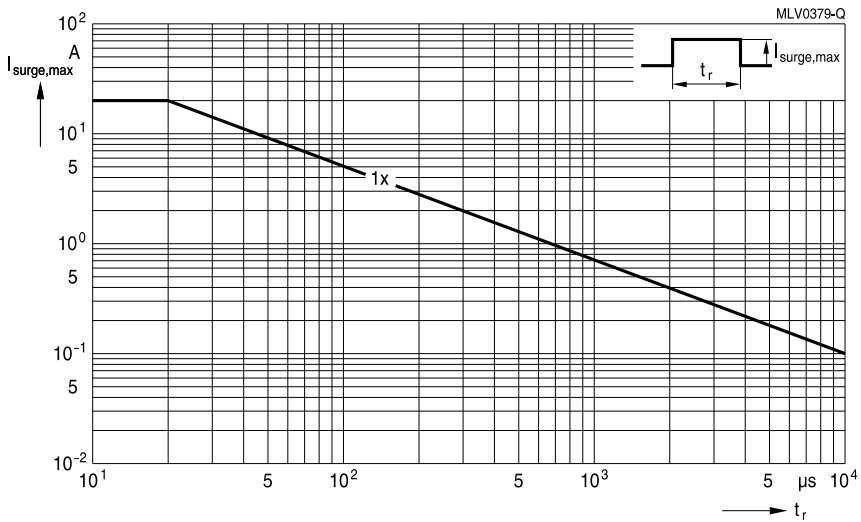

**CT0402M4G ... S17AG**

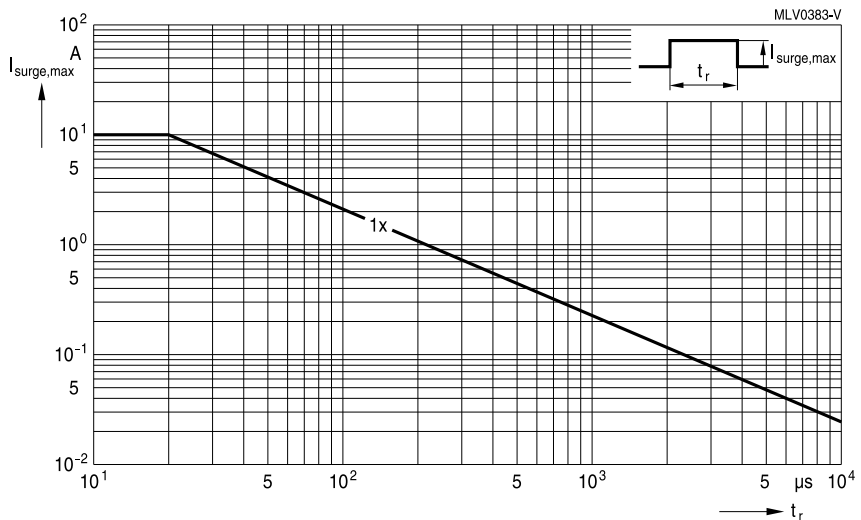

**CT0402L14UG**

## Multilayer varistors (MLVs)

### Standard series

### SMD

#### Derating curves

Maximum surge current  $I_{\text{surge,max}} = f(t_r, \text{pulse train})$

For explanation of the derating curves refer to "General technical information", chapter 2.7.2

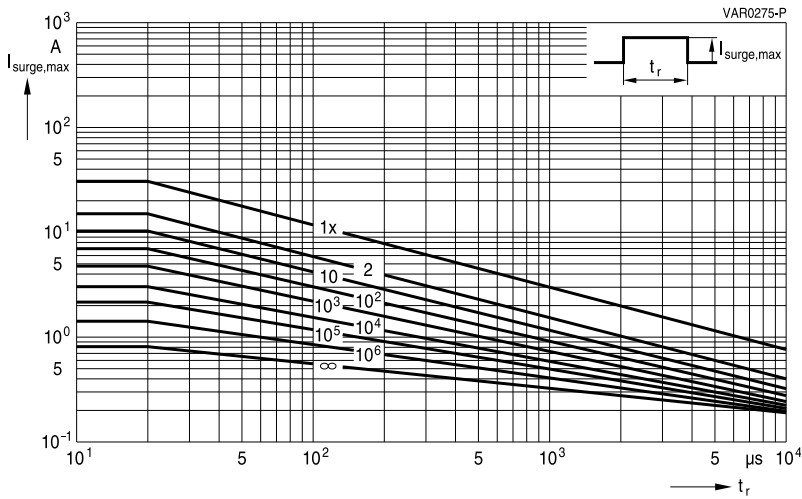

#### CT0603M4G ... K25G

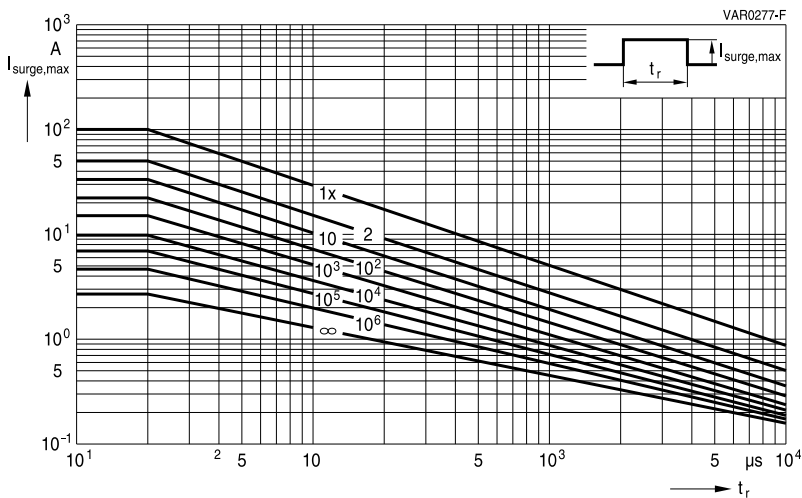

#### CT0805M4G

#### CT1206K35G ... K60G

## Multilayer varistors (MLVs)

### Standard series

### SMD

#### Derating curves

Maximum surge current  $I_{\text{surge,max}} = f(t_r, \text{pulse train})$

For explanation of the derating curves refer to "General technical information", chapter 2.7.2

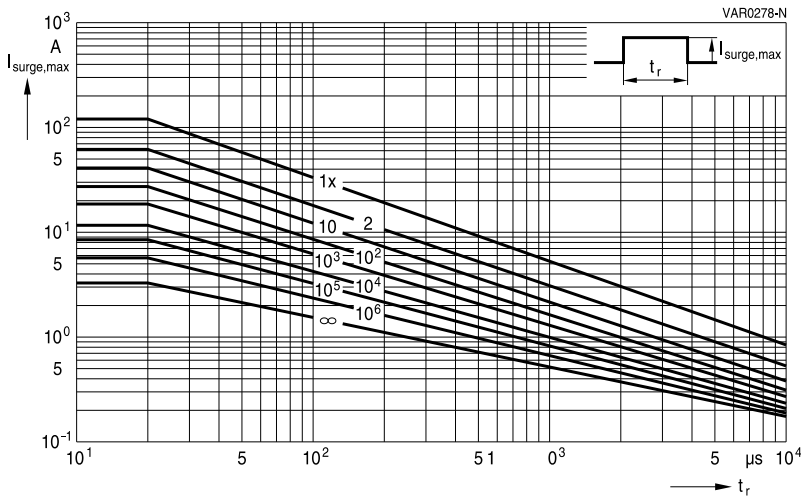

CT0805M6G ... K17G

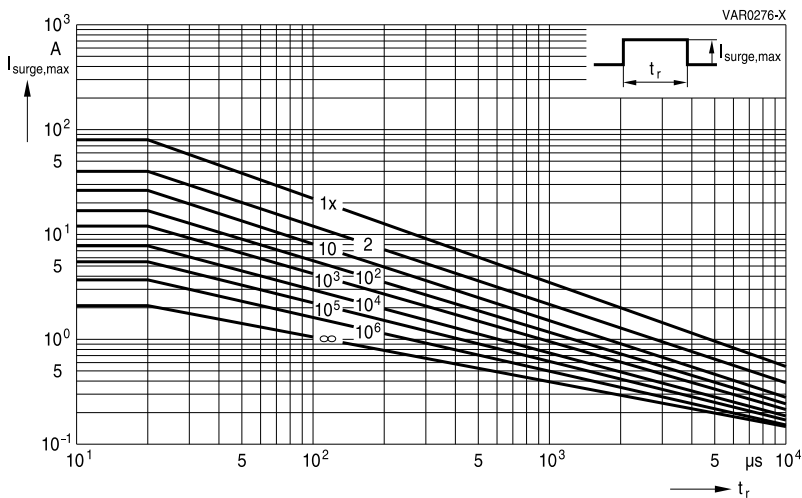

CT0805K20G ... K30G

## Multilayer varistors (MLVs)

### Standard series

### SMD

#### Derating curves

Maximum surge current  $I_{\text{surge,max}} = f(t_r, \text{pulse train})$

For explanation of the derating curves refer to "General technical information", chapter 2.7.2

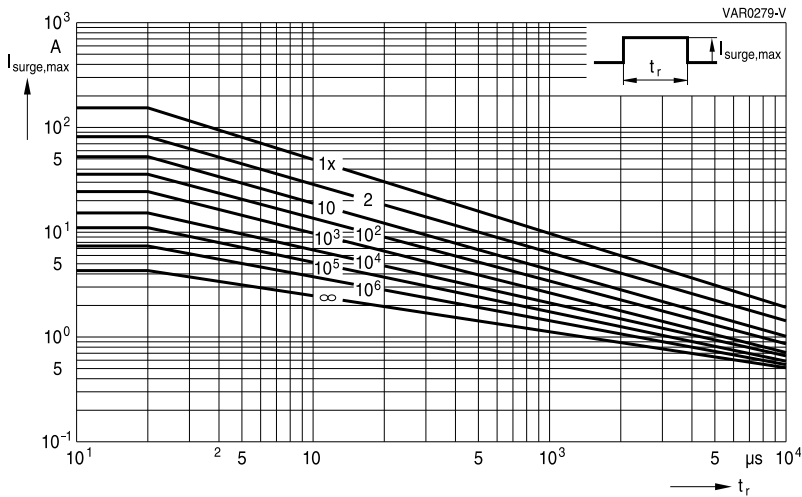

#### CT1206M4G

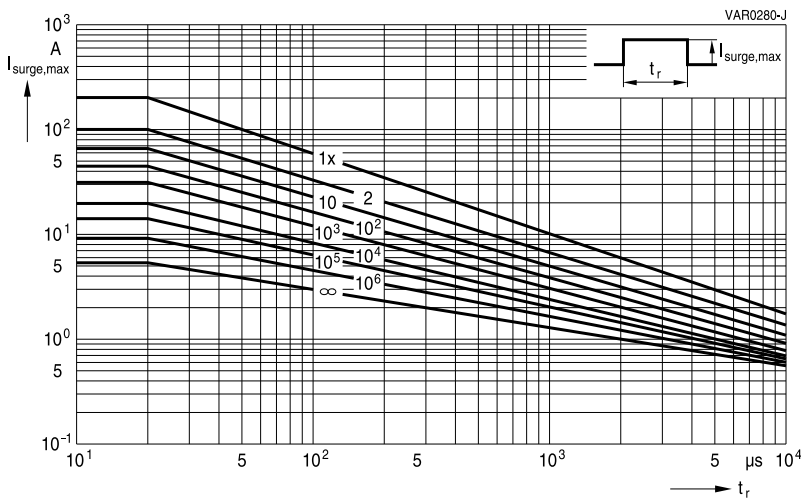

CT1206M6G ... K30G

CT1210K50G ... K60G

## Multilayer varistors (MLVs)

### Standard series

### SMD

#### Derating curves

Maximum surge current  $I_{\text{surge,max}} = f(t_r, \text{pulse train})$

For explanation of the derating curves refer to "General technical information", chapter 2.7.2

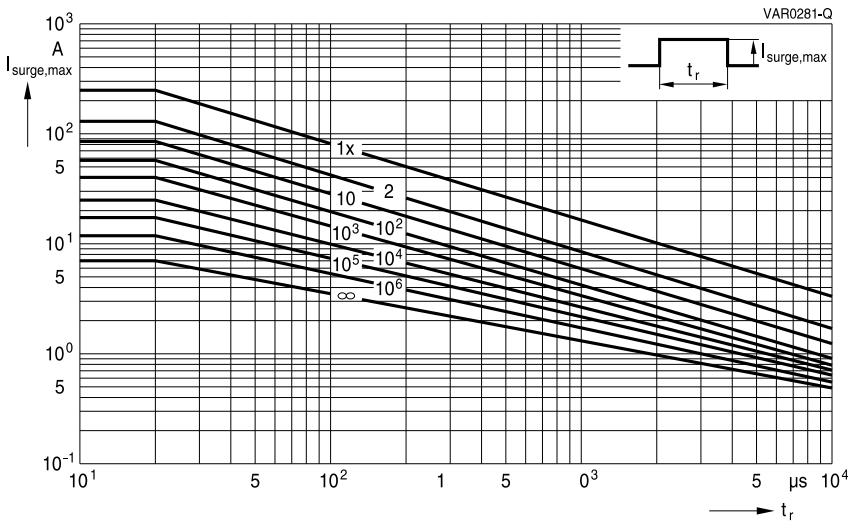

CT1210M4G

CT1210K35G ... K40G

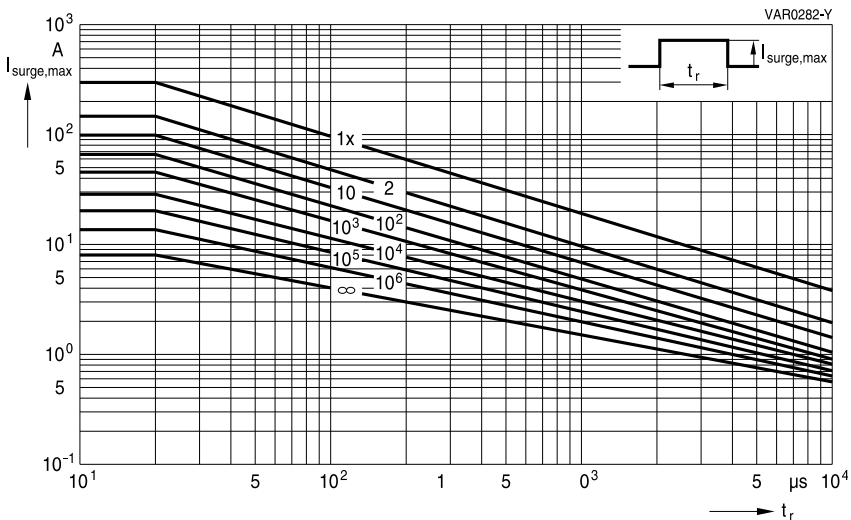

CT1210M6G

CT1210K25G ... K30G



## Multilayer varistors (MLVs)

### Standard series

### SMD

#### Derating curves

Maximum surge current  $I_{\text{surge,max}} = f(t_r, \text{pulse train})$

For explanation of the derating curves refer to "General technical information", chapter 2.7.2

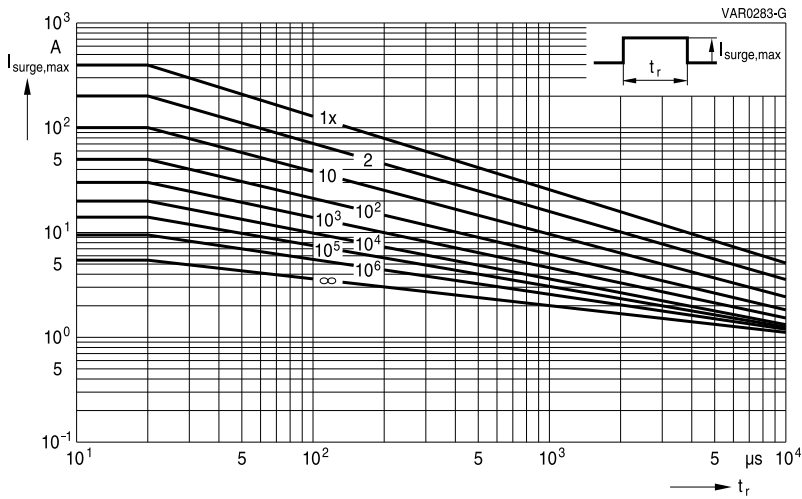

#### CT1210L8G ... K20G

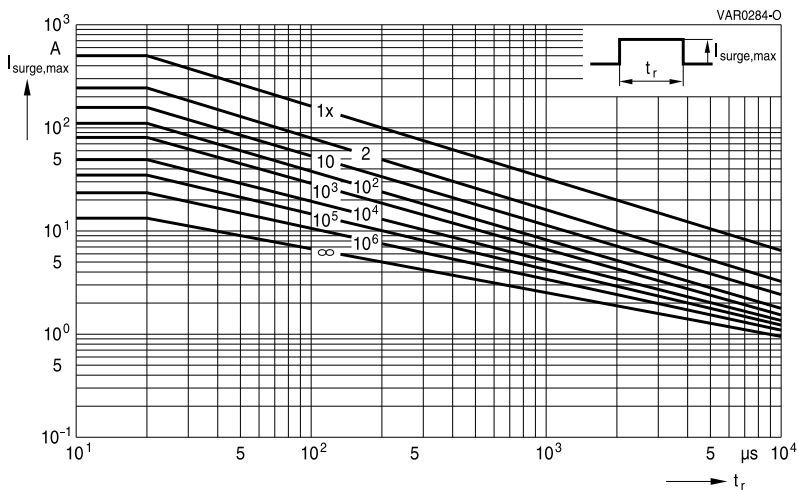

#### CN1812M4G ... M6G

#### CN1812K35GK2

## Multilayer varistors (MLVs)

### Standard series

### SMD

#### Derating curves

Maximum surge current  $I_{\text{surge,max}} = f(t_r, \text{pulse train})$

For explanation of the derating curves refer to "General technical information", chapter 2.7.2

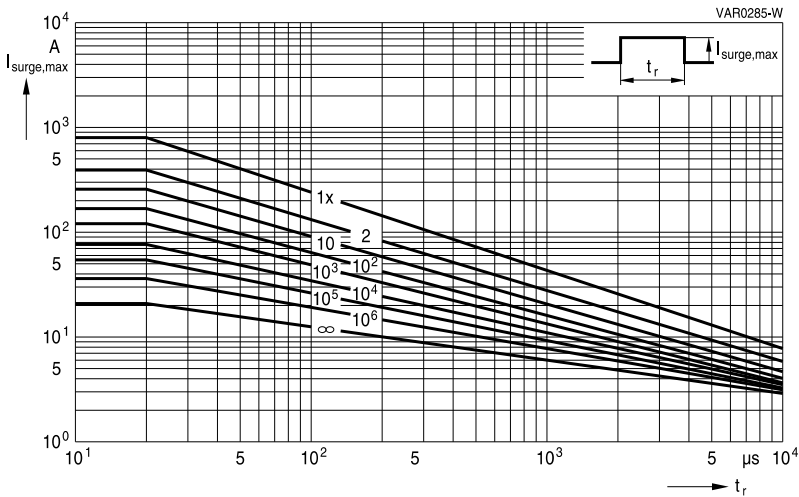

CN1812L8G ... K30G(K2)

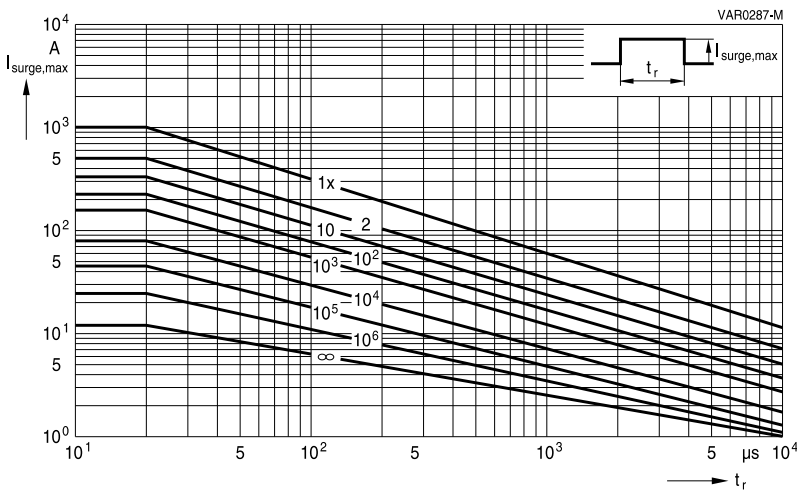

CN2220M4G

CN2220K35GK2, CN2220K40GK2

**Multilayer varistors (MLVs)**

**Standard series**

**SMD**

**Derating curves**

Maximum surge current  $I_{\text{surge,max}} = f(t_r, \text{pulse train})$

For explanation of the derating curves refer to "General technical information", chapter 2.7.2

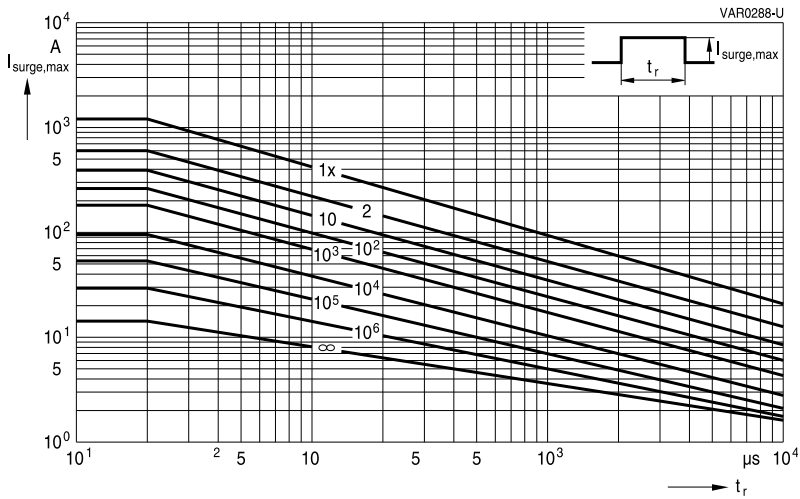

CN2220M6G ... K30G(K2)

## Multilayer varistors (MLVs)

### Standard series

### SMD

#### Taping and packing

#### 1 Taping and packing for SMD components

#### 1.1 Blister tape (the taping to IEC 60286-3)

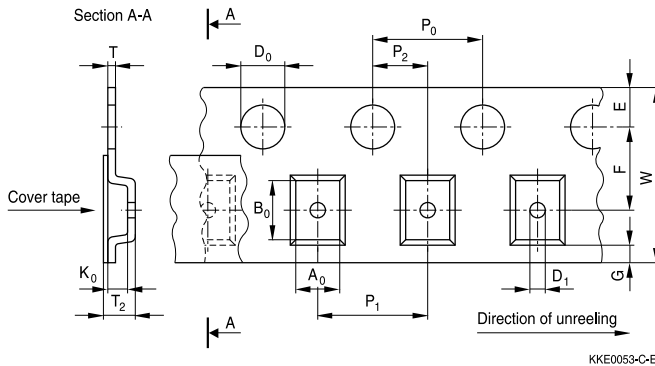

KKE0053-C-E

#### Dimensions in mm

	8-mm tape					12-mm tape		16-mm tape		Tolerance
	Case size (inch/mm)					Case size (inch/mm)		Case size (inch/mm)		
			0508/ 1220	0612/ 1632	1012/ 2532					
	0603/ 1608	0506/ 1216	0805/ 2012	1206/ 3216	1210/ 3225	1812/ 4532	2220/ 5750	3225	4032	
A <sub>0</sub>	0.9 ±0.10	1.50	1.60	1.90	2.80	3.50	5.10	7.00	8.60	±0.20
B <sub>0</sub>	1.75 ±0.10	1.80	2.40	3.50	3.50	4.80	6.00	8.70	10.60	±0.20
K <sub>0</sub>	1.0	0.80	1.80			2.60		5.00		max.
T	0.30					0.30		0.30		max.
T <sub>2</sub>	1.3	1.20	2.50			3.50		5.50		max.
D <sub>0</sub>	1.50					1.50		1.50		+0.10/-0
D <sub>1</sub>	1.00					1.50		1.50		min.
P <sub>0</sub>	4.00					4.00		4.00		±0.10 <sup>1)</sup>
P <sub>2</sub>	2.00					2.00		2.00		±0.05
P <sub>1</sub>	4.00					8.00		12.00		±0.10
W	8.00					12.00		16.00		±0.30
E	1.75					1.75		1.75		±0.10
F	3.50					5.50		7.50		±0.05
G	0.75					0.75		0.75		min.

1) ≤±0.2 mm over 10 sprocket holes.

## Multilayer varistors (MLVs)

### Standard series

### SMD

#### Part orientation in tape pocket for blister tape

For discrete chip, case sizes 0603, 0805, 1206, 1210, 1812 and 2220

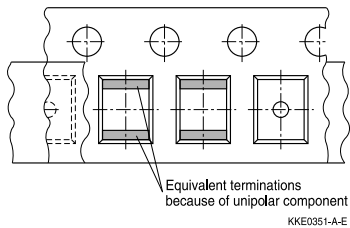

For array, case sizes 0612

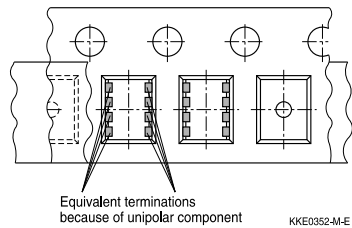

For arrays 0506 and 1012

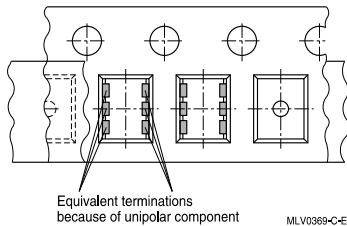

For filter array, case size 0508

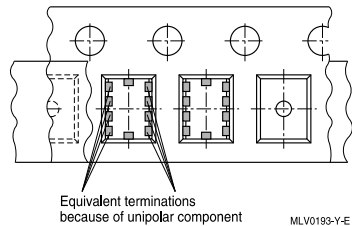

#### Additional taping information

Reel material	Polystyrol (PS)
Tape material	Polystyrol (PS) or Polycarbonat (PC) or PVC
Tape break force	min. 10 N
Top cover tape strength	min. 10 N
Top cover tape peel force	0.2 to 0.6 N for 8-mm tape and 0.2 to 0.8 N for 12-mm tape at a peel speed of 300 mm/min
Tape peel angle	Angle between top cover tape and the direction of feed during peel off: 165° to 180°
Cavity play	Each part rests in the cavity so that the angle between the part and cavity center line is no more than 20°

## Multilayer varistors (MLVs)

### Standard series

### SMD

#### 1.2 Cardboard tape (taping to IEC 60286-3)

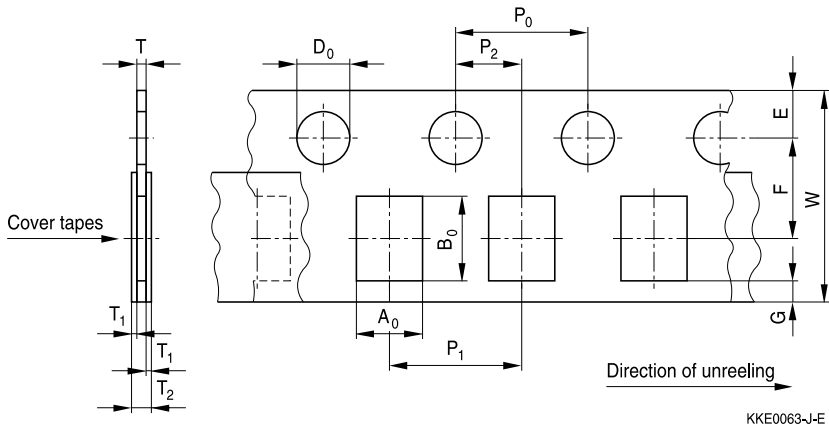

#### Dimensions in mm

	8-mm tape						Tolerance
	Case size (inch/mm)					Case size (inch/mm)	
	0201/0603	0402/1005	0405/1012	0603/1608	1003/2508	0508/1220	
A <sub>0</sub>	0.38 ±0.05	0.60	1.05	0.95	1.00	1.60	±0.20
B <sub>0</sub>	0.68 ±0.05	1.15	1.60	1.80	2.85	2.40	±0.20
T	0.35 ±0.02	0.60	0.75	0.95	1.00	0.95	max.
T <sub>2</sub>	0.4 min.	0.70	0.90	1.10	1.10	1.12	max.
D <sub>0</sub>	1.50 ±0.1	1.50				1.50	+0.10/-0
P <sub>0</sub>	4.00						±0.10 <sup>2)</sup>
P <sub>2</sub>	2.00						±0.05
P <sub>1</sub>	2.00 ±0.05	2.00	4.00	4.00	4.00	4.00	±0.10
W	8.00						±0.30
E	1.75						±0.10
F	3.50						±0.05
G	1.35	0.75					min.

2) ≤0.2 mm over 10 sprocket holes.

## Multilayer varistors (MLVs)

### Standard series

#### SMD

#### Part orientation in tape pocket for cardboard tape

For discrete chip case sizes 0201, 0402, 0603 and 1003

For array case size 0405

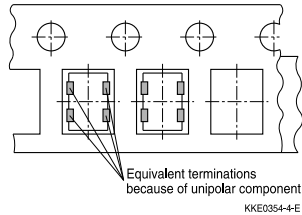
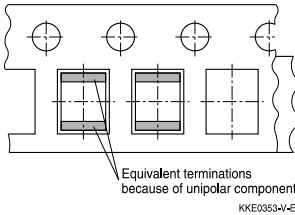

For array case size 0508

For filter array, case size 0405

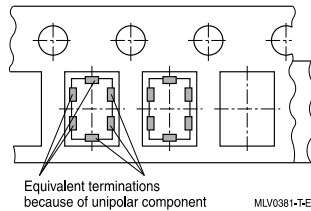
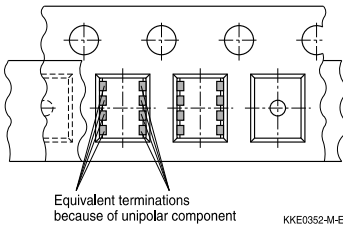

#### Additional taping information

Reel material	Polystyrol (PS)
Tape material	Cardboard
Tape break force	min. 10 N
Top cover tape strength	min. 10 N
Top cover tape peel force	0.1 to 0.65 N at a peel speed of 300 mm/min
Tape peel angle	Angle between top cover tape and the direction of feed during peel off: 165° to 180°
Cavity play	Each part rests in the cavity so that the angle between the part and cavity center line is no more than 20°

## Multilayer varistors (MLVs)

### Standard series

#### SMD

### 1.3 Reel packing

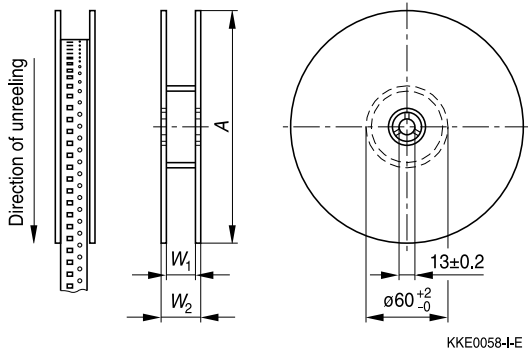

#### Dimensions in mm

	8-mm tape		12-mm tape		16-mm tape
	180-mm reel	330-mm reel	180-mm reel	330-mm reel	330-mm reel
A	180 -3/+0	330 -2.0	180 -3/+0	330 -2.0	330 -2.0
W <sub>1</sub>	8.4 +1.5/-0	8.4 +1.5/-0	12.4 +1.5/-0	12.4 +1.5/-0	16.4 +1.5/-0
W <sub>2</sub>	14.4 max.	14.4 max.	18.4 max.	18.4 max.	22.4 max.

#### Leader, trailer

Tape end (Trailer)

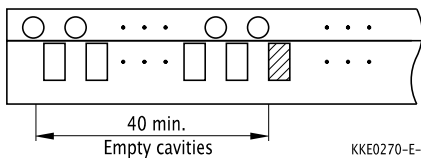

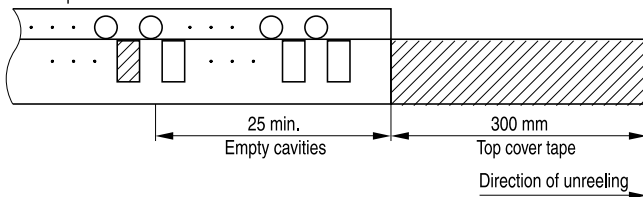

Leader part



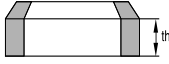
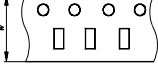
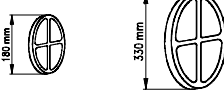

**Multilayer varistors (MLVs)**
**Standard series**
SMD
**1.4 Packing units for discrete chip and array chip**

Case size inch/mm	 Chip thickness th			 Ø 180-mm reel	 Ø 330-mm reel
		Cardboard tape W	Blister tape W	pcs.	pcs.
0201/0603	0.33 mm	8 mm	–	15000	–
0402/1005	0.6 mm	8 mm	–	10000	–
0405/1012	0.7 mm	8 mm	–	5000	–
0506/1216	0.5 mm	–	8 mm	4000	–
0508/1220	0.9 mm	8 mm	8 mm	4000	–
0603/1608	0.9 mm	8 mm	8 mm	4000	16000
0612/1632	0.9 mm	–	8 mm	3000	–
0805/2012	0.7 mm	–	8 mm	3000	–
	0.9 mm	–	8 mm	3000	12000
	1.3 mm	–	8 mm	3000	–
1003/2508	0.9 mm	8 mm	–	4000	–
1012/2532	1.0 mm	–	8 mm	2000	–
1206/3216	0.9 mm	–	8 mm	3000	–
	1.3 mm	–	8 mm	3000	–
	1.4 mm	–	8 mm	2000	–
	1.6 mm	–	8 mm	2000	–
1210/3225	0.9 mm	–	8 mm	3000	–
	1.3 mm	–	8 mm	3000	–
	1.4 mm	–	8 mm	2000	–
	1.6 mm	–	8 mm	2000	–
1812/4532	1.3 mm	–	12 mm	1500	–
	1.4 mm	–	12 mm	1000	–
	1.6 mm	–	12 mm	–	4000
	2.3 mm	–	12 mm	–	3000
2220/5750	1.3 mm	–	12 mm	1500	–
	1.4 mm	–	12 mm	1000	–
	2.0 mm	–	12 mm	–	3000
	2.3 mm	–	12 mm	–	3000
3225	3.2 mm	–	16 mm	–	1000
	4.5 mm	–	16 mm	–	1000
4032	3.2 mm	–	16 mm	–	1000
	4.5 mm	–	16 mm	–	1000

**Multilayer varistors (MLVs)****Standard series****SMD****2 Delivery mode for leaded SHCV varistors**

Standard delivery mode for SHCV types is bulk. Alternative taping modes (AMMO pack or taped on reel) are available upon request.

Packing units for:

Type	Pieces
SR6	2000
SR1 / SR2	1000

For types not listed in this data book please contact EPCOS.

## Multilayer varistors (MLVs)

### Standard series

### SMD

#### Soldering directions

#### 1 Terminations

##### 1.1 Nickel barrier termination

The nickel barrier layer of the silver/nickel/tin termination prevents leaching of the silver base metallization layer. This allows great flexibility in the selection of soldering parameters. The tin prevents the nickel layer from oxidizing and thus ensures better wetting by the solder. The nickel barrier termination is suitable for all commonly-used soldering methods.

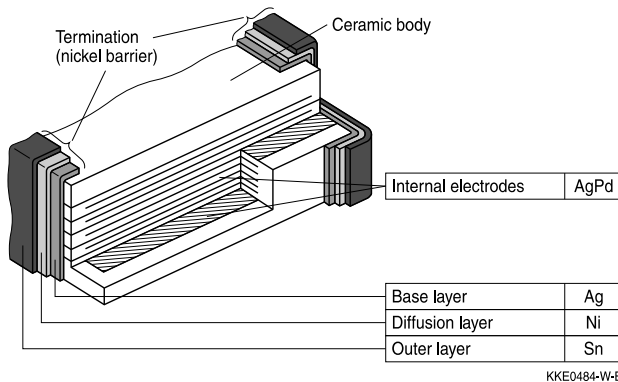

Multilayer CTVS: Structure of nickel barrier termination

##### 1.2 Silver-palladium termination

Silver-palladium terminations are used for the large case sizes 1812 and 2220 and for chips intended for conductive adhesion. This metallization improves the resistance of large chips to thermal shock.

In case of conductive adhesion, the silver-palladium metallization reduces susceptibility to corrosion. Silver-palladium termination can be used for smaller case sizes (only chip) for hybrid applications as well. The silver-palladium termination is not approved for lead-free soldering.

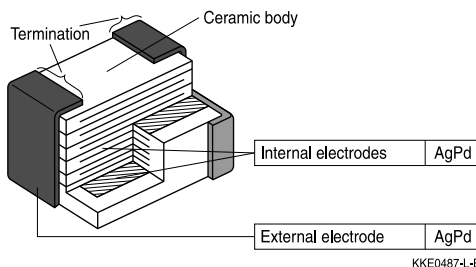

Multilayer varistor: Structure of silver-palladium termination

## Multilayer varistors (MLVs)

### Standard series

### SMD

#### 1.3 Silver-platinum termination

Silver-platinum terminations are mainly used for the large case sizes 1812 and 2220. The silver-platinum termination is approved for reflow soldering, SnPb soldering and lead-free soldering with a silver containing solder paste. In case of SnPb soldering, a solder paste Sn62Pb36Ag2 is recommended. For lead-free reflow soldering, a solder paste SAC, e.g. Sn95.5Ag3.8Cu0.7, is recommended.

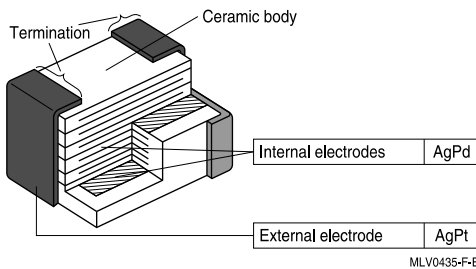

Multilayer varistor: Structure of silver-platinum termination

## 2 Recommended soldering temperature profiles

### 2.1 Reflow soldering temperature profile

#### Recommended temperature characteristic for reflow soldering following JEDEC J-STD-020D

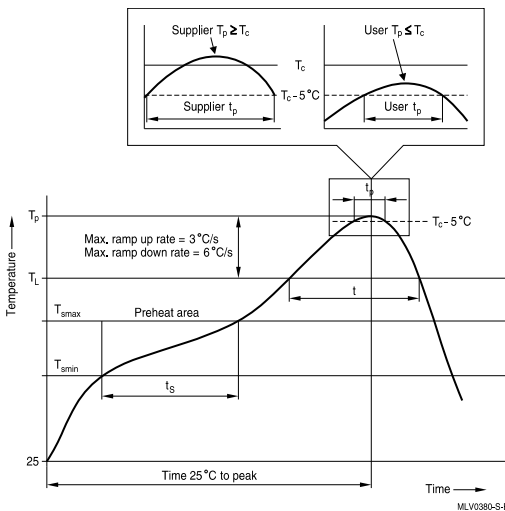



## Multilayer varistors (MLVs)

### Standard series

#### SMD

### 2.3 Lead-free soldering processes

EPCOS multilayer CTVS with AgNiSn termination are designed for the requirements of lead-free soldering processes only.

Soldering temperature profiles to JEDEC J-STD-020D, IEC 60068-2-58 and ZVEI recommendations.

## 3 Recommended soldering methods - type-specific releases by EPCOS

### 3.1 Overview

Type	Case size	Reflow soldering		Wave soldering	
		SnPb	Lead-free	SnPb	Lead-free
CT... / CD...	0201/ 0402	Approved	Approved	No	No
CT... / CD...	0603 ... 2220	Approved	Approved	Approved	Approved
CN...	0603 ... 2220	Approved	No	Approved	No
CN...K2	1812, 2220	Approved	Approved	No	No
Arrays	0405 ... 1012	Approved	Approved	No	No
ESD/EMI filters	0405, 0508	Approved	Approved	No	No
CU	3225, 4032	Approved	Approved	Approved	Approved
SHCV	-	No	No	Approved	Approved

### 3.2 Nickel barrier and AgPt terminated multilayer CTVS

All EPCOS MLVs with nickel barrier and AgPt termination are suitable and fully qualified for lead-free soldering. The nickel barrier layer is 100% matte tin-plated.

### 3.3 Silver-palladium terminated MLVs

AgPd-terminated MLVs are mainly designed for conductive adhesion technology on hybrid material. Additionally MLVs with AgPd termination are suitable for reflow and wave soldering with SnPb solder.

#### **Note:**

Lead-free soldering is not approved for MLVs with AgPd termination.

### 3.4 Silver-platinum terminated MLVs

The silver-platinum termination is approved for reflow soldering, SnPb soldering and lead-free with a silver containing solder paste. In case of SnPb soldering, a solder paste Sn62Pb36Ag2 is recommended. For lead-free reflow soldering, a solder paste SAC, e.g. Sn95.5Ag3.8Cu0.7, is recommended.

## Multilayer varistors (MLVs)

### Standard series

#### SMD

### 3.5 Tinned copper alloy

All EPCOS CU types with tinned termination are approved for lead-free and SnPb soldering.

### 3.6 Tinned iron wire

All EPCOS SHCV types with tinned termination are approved for lead-free and SnPb soldering.

## 4 Solder joint profiles / solder quantity

### 4.1 Nickel barrier termination

If the meniscus height is too low, that means the solder quantity is too low, the solder joint may break, i.e. the component becomes detached from the joint. This problem is sometimes interpreted as leaching of the external terminations.

If the solder meniscus is too high, i.e. the solder quantity is too large, the vise effect may occur. As the solder cools down, the solder contracts in the direction of the component. If there is too much solder on the component, it has no leeway to evade the stress and may break, as in a vise.

The figures below show good and poor solder joints for dual-wave and infrared soldering.

#### 4.1.1 Solder joint profiles for nickel barrier termination - dual-wave soldering

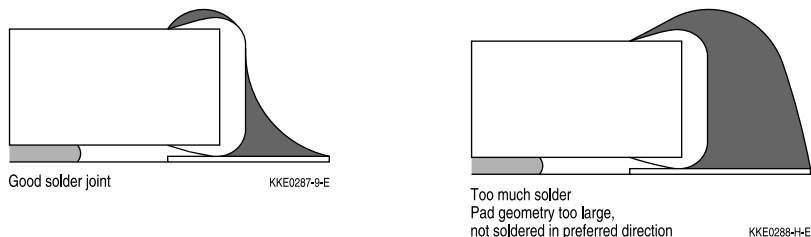

Good and poor solder joints caused by amount of solder in dual-wave soldering.

#### 4.1.2 Solder joint profiles for nickel barrier termination / silver-palladium / silver-platinum termination - reflow soldering

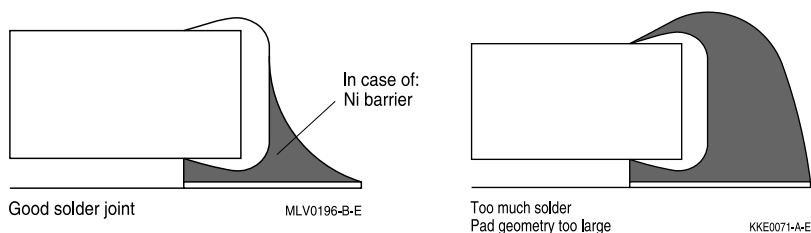

## Multilayer varistors (MLVs)

### Standard series

#### SMD

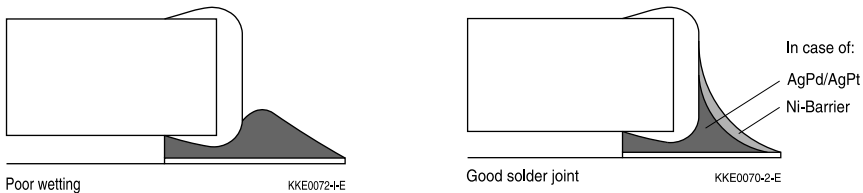

Good and poor solder joints caused by amount of solder in reflow soldering.

## 5 Conductive adhesion

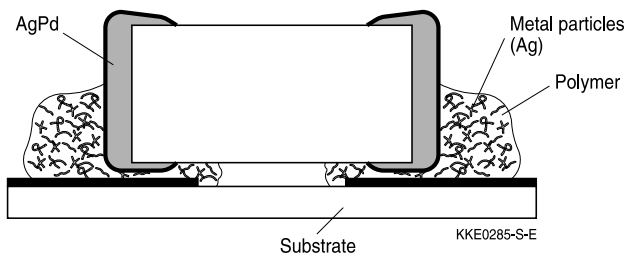

Attaching surface-mounted devices (SMDs) with electrically conductive adhesives is a commercially attractive method of component connection to supplement or even replace conventional soldering methods.

Electrically conductive adhesives consist of a non-conductive plastic (epoxy resin, polyimide or silicon) in which electrically conductive metal particles (gold, silver, palladium, nickel, etc) are embedded. Electrical conduction is effected by contact between the metal particles.

Adhesion is particularly suitable for meeting the demands of hybrid technology. The adhesives can be deposited ready for production requirements by screen printing, stamping or by dispensers. As shown in the following table, conductive adhesion involves two work operations fewer than soldering.

Reflow soldering	Wave soldering	Conductive adhesion
Screen-print solder paste	Apply glue dot	Screen-print conductive adhesive
Mount SMD	Mount SMD	Mount SMD
Predry solder paste	Cure glue	Cure adhesive
Reflow soldering	Wave soldering	Inspect
Wash	Wash	
Inspect	Inspect	



## Multilayer varistors (MLVs)

### Standard series

#### SMD

A further advantage of adhesion is that the components are subjected to virtually no temperature shock at all. The curing temperatures of the adhesives are between 120 °C and 180 °C, typical curing times are between 30 minutes and one hour.

The bending strength of glued chips is, in comparison with that of soldered chips, higher by a factor of at least 2, as is to be expected due to the elasticity of the glued joints.

The lower conductivity of conductive adhesive may lead to higher contact resistance and thus result in electrical data different to those of soldered components. Users must pay special attention to this in RF applications.

### 6 Solderability tests

Test	Standard	Test conditions Sn-Pb soldering	Test conditions Pb-free soldering	Criteria/ test results
Wettability	IEC 60068-2-58	Immersion in 60/40 SnPb solder using non-activated flux at $215 \pm 3$ °C for $3 \pm 0.3$ s	Immersion in Sn96.5Ag3.0Cu0.5 solder using non- or low activated flux at $245 \pm 5$ °C for $3 \pm 0.3$ s	Covering of 95% of end termination, checked by visual inspection
Leaching resistance	IEC 60068-2-58	Immersion in 60/40 SnPb solder using mildly activated flux without preheating at $260 \pm 5$ °C for $10 \pm 1$ s	Immersion in Sn96.5Ag3.0Cu0.5 solder using non- or low activated flux without preheating at $255 \pm 5$ °C for $10 \pm 1$ s	No leaching of contacts
Thermal shock (solder shock)		Dip soldering at $300$ °C/5 s	Dip soldering at $300$ °C/5 s	No deterioration of electrical parameters. Capacitance change: $\leq \pm 15\%$
Tests of resistance to soldering heat for SMDs	IEC 60068-2-58	Immersion in 60/40 SnPb for 10 s at $260$ °C	Immersion in Sn96.5Ag3.0Cu0.5 for 10 s at $260$ °C	Change of varistor voltage: $\leq \pm 5\%$
Tests of resistance to soldering heat for radial leaded components (SHCV)	IEC 60068-2-20	Immersion of leads in 60/40 SnPb for 10 s at $260$ °C	Immersion of leads in Sn96.5Ag3.0Cu0.5 for 10 s at $260$ °C	Change of varistor voltage: $\leq \pm 5\%$ Change of capacitance X7R: $\leq -5/+10\%$

## Multilayer varistors (MLVs)

### Standard series

#### SMD

#### Note:

#### Leaching of the termination

Effective area at the termination might be lost if the soldering temperature and/or immersion time are not kept within the recommended conditions. Leaching of the outer electrode should not exceed 25% of the chip end area (full length of the edge A-B-C-D) and 25% of the length A-B, shown below as mounted on substrate.

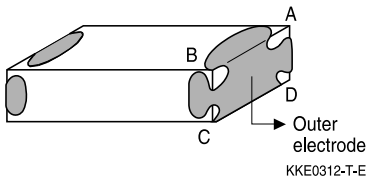

As a single chip

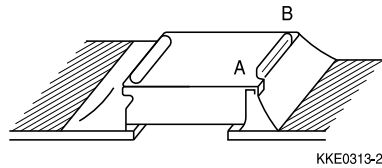

As mounted on substrate

## 7 Notes for proper soldering

### 7.1 Preheating and cooling

- According to JEDEC J-STD-020D. Please refer to chapter 2.

### 7.2 Repair / rework

Manual soldering with a soldering iron must be avoided, hot-air methods are recommended for rework purposes.

### 7.3 Cleaning

All environmentally compatible agents are suitable for cleaning. Select the appropriate cleaning solution according to the type of flux used. The temperature difference between the components and cleaning liquid must not be greater than 100 °C. Ultrasonic cleaning should be carried out with the utmost caution. Too high ultrasonic power can impair the adhesive strength of the metalized surfaces.

### 7.4 Solder paste printing (reflow soldering)

An excessive application of solder paste results in too high a solder fillet, thus making the chip more susceptible to mechanical and thermal stress. Too little solder paste reduces the adhesive strength on the outer electrodes and thus weakens the bonding to the PCB. The solder should be applied smoothly to the end surface.

## Multilayer varistors (MLVs)

### Standard series

#### SMD

#### 7.5 Adhesive application

Thin or insufficient adhesive causes chips to loosen or become disconnected during curing. Low viscosity of the adhesive causes chips to slip after mounting. It is advised to consult the manufacturer of the adhesive on proper usage and amounts of adhesive to use.

#### 7.6 Selection of flux

Used flux should have less than or equal to 0.1 wt % of halogenated content, since flux residue after soldering could lead to corrosion of the termination and/or increased leakage current on the surface of the component. Strong acidic flux must not be used. The amount of flux applied should be carefully controlled, since an excess may generate flux gas, which in turn is detrimental to solderability.

#### 7.7 Storage of CTVs

Solderability is guaranteed for one year from date of delivery for multilayer varistors, CeraDiodes and ESD/EMI filters (half a year for chips with AgPd and AgPt terminations) and two years for SHCV and CU components, provided that components are stored in their original packages.

Storage temperature:  $-25\text{ }^{\circ}\text{C}$  to  $+45\text{ }^{\circ}\text{C}$

Relative humidity:  $\leq 75\%$  annual average,  $\leq 95\%$  on 30 days a year

The solderability of the external electrodes may deteriorate if SMDs and leaded components are stored where they are exposed to high humidity, dust or harmful gas (hydrogen chloride, sulfurous acid gas or hydrogen sulfide).

Do not store SMDs and leaded components where they are exposed to heat or direct sunlight. Otherwise the packing material may be deformed or SMDs/ leaded components may stick together, causing problems during mounting.

After opening the factory seals, such as polyvinyl-sealed packages, it is recommended to use the SMDs or leaded components as soon as possible.

#### 7.8 Placement of components on circuit board

Especially in the case of dual-wave soldering, it is of advantage to place the components on the board before soldering in that way that their two terminals do not enter the solder bath at different times.

Ideally, both terminals should be wetted simultaneously.

#### 7.9 Soldering cautions

- An excessively long soldering time or high soldering temperature results in leaching of the outer electrodes, causing poor adhesion and a change of electrical properties of the varistor due to the loss of contact between electrodes and termination.
- Wave soldering must not be applied for MLVs designated for reflow soldering only.
- Keep the recommended down-cooling rate.

## Multilayer varistors (MLVs)

### Standard series

#### SMD

#### 7.10 Standards

CECC 00802

IEC 60068-2-58

IEC 60068-2-20

JEDEC J-STD-020D

## Multilayer varistors (MLVs)

### Standard series

#### SMD

#### Symbols and terms

Symbol	Term
$C_{line,typ}$	Typical capacitance per line
$C_{max}$	Maximum capacitance
$C_{min}$	Minimum capacitance
$C_{nom}$	Nominal capacitance
$\Delta C_{nom}$	Tolerance of nominal capacitance
$C_{typ}$	Typical capacitance
$f_{cut-off,min}$	Minimum cut-off frequency
$I$	Current
$I_{clamp}$	Clamping current
$I_{leak}$	Leakage current
$I_{leak,typ}$	Typical leakage current
$I_{PP}$	Peak pulse current
$I_{surge,max}$	Maximum surge current (also termed peak current)
LCT	Lower category temperature
$L_{typ}$	Typical inductance
$P_{diss,max}$	Maximum power dissipation
$P_{PP}$	Peak pulse power
$R_{ins}$	Insulation resistance
$R_{min}$	Minimum resistance
$R_S$	Resistance per line
$T_A$	Ambient temperature
$T_{op}$	Operating temperature
$T_{stg}$	Storage temperature
$t_r$	Duration of equivalent rectangular wave
$t_{resp}$	Response time
UCT	Upper category temperature
$V$	Voltage
$V_{BR,min}$	Minimum breakdown voltage
$V_{clamp,max}$	Maximum clamping voltage
$V_{DC,max}$	Maximum DC operating voltage (also termed working voltage)
$V_{ESD,air}$	Air discharge ESD capability
$V_{ESD,contact}$	Contact discharge ESD capability
$V_{jump}$	Maximum jump start voltage

## Multilayer varistors (MLVs)

### Standard series

#### SMD

$V_{\text{RMS,max}}$	Maximum AC operating voltage, root-mean-square value
$V_V$	Varistor voltage (also termed breakdown voltage)
$V_{V,\text{min}}$	Minimum varistor voltage
$V_{V,\text{max}}$	Maximum varistor voltage
$\Delta V_V$	Tolerance of varistor voltage
$W_{\text{LD}}$	Maximum load dump
$W_{\text{max}}$	Maximum energy absorption (also termed transient energy)
$\alpha_{\text{typ}}$	Typical insertion loss
$e$	Lead spacing
$\ll * \gg$	Maximum possible application conditions

All dimensions are given in mm.

The commas used in numerical values denote decimal points.

## Multilayer varistors (MLVs)

### Standard series

#### SMD

### Cautions and warnings

#### General

Some parts of this publication contain statements about the suitability of our ceramic transient voltage suppressor (CTVS) components (multilayer varistors (MLVs), CeraDiodes, ESD/EMI filters, SMD disk varistors (CU types), leaded transient voltage/ RFI suppressors (SHCV types)) for certain areas of application, including recommendations about incorporation/design-in of these products into customer applications. The statements are based on our knowledge of typical requirements often made of our CTVS devices in the particular areas. We nevertheless expressly point out that such statements cannot be regarded as binding statements about the suitability of our CTVS components for a particular customer application. As a rule, EPCOS is either unfamiliar with individual customer applications or less familiar with them than the customers themselves. For these reasons, it is always incumbent on the customer to check and decide whether the CTVS devices with the properties described in the product specification are suitable for use in a particular customer application.

- Do not use EPCOS CTVS components for purposes not identified in our specifications, application notes and data books.
- Ensure the suitability of a CTVS in particular by testing it for reliability during design-in. Always evaluate a CTVS component under worst-case conditions.
- Pay special attention to the reliability of CTVS devices intended for use in safety-critical applications (e.g. medical equipment, automotive, spacecraft, nuclear power plant).

#### Design notes

- Always connect a CTVS in parallel with the electronic circuit to be protected.
- Consider maximum rated power dissipation if a CTVS has insufficient time to cool down between a number of pulses occurring within a specified isolated time period. Ensure that electrical characteristics do not degrade.
- Consider derating at higher operating temperatures. Choose the highest voltage class compatible with derating at higher temperatures.
- Surge currents beyond specified values will puncture a CTVS. In extreme cases a CTVS will burst.
- If steep surge current edges are to be expected, make sure your design is as low-inductance as possible.
- In some cases the malfunctioning of passive electronic components or failure before the end of their service life cannot be completely ruled out in the current state of the art, even if they are operated as specified. In applications requiring a very high level of operational safety and especially when the malfunction or failure of a passive electronic component could endanger human life or health (e.g. in accident prevention, life-saving systems, or automotive battery line applications such as clamp 30), ensure by suitable design of the application or other measures (e.g. installation of protective circuitry or redundancy) that no injury or damage is sustained by third parties in the event of such a malfunction or failure. Only use CTVS components from the automotive series in safety-relevant applications.

## Multilayer varistors (MLVs)

### Standard series

#### SMD

- Specified values only apply to CTVS components that have not been subject to prior electrical, mechanical or thermal damage. The use of CTVS devices in line-to-ground applications is therefore not advisable, and it is only allowed together with safety countermeasures like thermal fuses.

#### Storage

- Only store CTVS in their original packaging. Do not open the package before storage.
- Storage conditions in original packaging: temperature  $-25$  to  $+45^{\circ}\text{C}$ , relative humidity  $\leq 75\%$  annual average, maximum 95%, dew precipitation is inadmissible.
- Do not store CTVS devices where they are exposed to heat or direct sunlight. Otherwise the packaging material may be deformed or CTVS may stick together, causing problems during mounting.
- Avoid contamination of the CTVS surface during storage, handling and processing.
- Avoid storing CTVS devices in harmful environments where they are exposed to corrosive gases for example ( $\text{SO}_x$ , Cl).
- Use CTVS as soon as possible after opening factory seals such as polyvinyl-sealed packages.
- Solder CTVS components after shipment from EPCOS within the time specified:
  - CTVS with Ni barrier termination, 12 months
  - CTVS with AgPd and AgPt termination, 6 months
  - SHCV and CU series, 24 months

#### Handling

- Do not drop CTVS components and allow them to be chipped.
- Do not touch CTVS with your bare hands - gloves are recommended.
- Avoid contamination of the CTVS surface during handling.

#### Mounting

- When CTVS devices are encapsulated with sealing material or overmolded with plastic material, electrical characteristics might be degraded and the life time reduced.
- Make sure an electrode is not scratched before, during or after the mounting process.
- Make sure contacts and housings used for assembly with CTVS components are clean before mounting.
- The surface temperature of an operating CTVS can be higher. Ensure that adjacent components are placed at a sufficient distance from a CTVS to allow proper cooling.
- Avoid contamination of the CTVS surface during processing.
- Multilayer varistors (MLVs) with AgPd termination are not approved for lead-free soldering.

#### Soldering

- Complete removal of flux is recommended to avoid surface contamination that can result in an instable and/or high leakage current.
- Use resin-type or non-activated flux.
- Bear in mind that insufficient preheating may cause ceramic cracks.
- Rapid cooling by dipping in solvent is not recommended, otherwise a component may crack.



## Multilayer varistors (MLVs)

### Standard series

#### SMD

#### Conductive adhesive gluing

- Only multilayer varistors (MLVs) with an AgPd termination are approved for conductive adhesive gluing.

#### Operation

- Use CTVS only within the specified operating temperature range.
- Use CTVS only within specified voltage and current ranges.
- Environmental conditions must not harm a CTVS. Only use them in normal atmospheric conditions. Reducing the atmosphere (e.g. hydrogen or nitrogen atmosphere) is prohibited.
- Prevent a CTVS from contacting liquids and solvents. Make sure that no water enters a CTVS (e.g. through plug terminals).
- Avoid dewing and condensation.
- EPCOS CTVS components are mainly designed for encased applications. Under all circumstances avoid exposure to:
  - direct sunlight
  - rain or condensation
  - steam, saline spray
  - corrosive gases
  - atmosphere with reduced oxygen content
- EPCOS CTVS devices are not suitable for switching applications or voltage stabilization where static power dissipation is required.
- Multilayer varistors (MLVs) are designed for ESD protection and transient suppression. CeraDiodes are designed for ESD protection only, ESD/EMI filters are designed for ESD and EMI protection only.

This listing does not claim to be complete, but merely reflects the experience of EPCOS AG.

## Important notes

The following applies to all products named in this publication:

1. Some parts of this publication contain **statements about the suitability of our products for certain areas of application**. These statements are based on our knowledge of typical requirements that are often placed on our products in the areas of application concerned. We nevertheless expressly point out **that such statements cannot be regarded as binding statements about the suitability of our products for a particular customer application**. As a rule, EPCOS is either unfamiliar with individual customer applications or less familiar with them than the customers themselves. For these reasons, it is always ultimately incumbent on the customer to check and decide whether an EPCOS product with the properties described in the product specification is suitable for use in a particular customer application.
2. We also point out that **in individual cases, a malfunction of electronic components or failure before the end of their usual service life cannot be completely ruled out in the current state of the art, even if they are operated as specified**. In customer applications requiring a very high level of operational safety and especially in customer applications in which the malfunction or failure of an electronic component could endanger human life or health (e.g. in accident prevention or lifesaving systems), it must therefore be ensured by means of suitable design of the customer application or other action taken by the customer (e.g. installation of protective circuitry or redundancy) that no injury or damage is sustained by third parties in the event of malfunction or failure of an electronic component.
3. **The warnings, cautions and product-specific notes must be observed.**
4. In order to satisfy certain technical requirements, **some of the products described in this publication may contain substances subject to restrictions in certain jurisdictions (e.g. because they are classed as hazardous)**. Useful information on this will be found in our Material Data Sheets on the Internet ([www.epcos.com/material](http://www.epcos.com/material)). Should you have any more detailed questions, please contact our sales offices.
5. We constantly strive to improve our products. Consequently, **the products described in this publication may change from time to time**. The same is true of the corresponding product specifications. Please check therefore to what extent product descriptions and specifications contained in this publication are still applicable before or when you place an order. We also **reserve the right to discontinue production and delivery of products**. Consequently, we cannot guarantee that all products named in this publication will always be available. The aforementioned does not apply in the case of individual agreements deviating from the foregoing for customer-specific products.
6. Unless otherwise agreed in individual contracts, **all orders are subject to the current version of the "General Terms of Delivery for Products and Services in the Electrical Industry" published by the German Electrical and Electronics Industry Association (ZVEI)**.
7. The trade names EPCOS, BAOKE, Alu-X, CeraDiode, CSMP, CSSP, CTVS, DeltaCap, DigiSiMic, DSSP, FormFit, MiniBlue, MiniCell, MKK, MKD, MLSC, MotorCap, PCC, PhaseCap, PhaseCube, PhaseMod, PhiCap, SIFERRIT, SIFI, SIKOREL, SilverCap, SIMDAD, SiMic, SIMID, SineFormer, SIOV, SIP5D, SIP5K, ThermoFuse, WindCap are **trade-marks registered or pending** in Europe and in other countries. Further information will be found on the Internet at [www.epcos.com/trademarks](http://www.epcos.com/trademarks).