

ERmet[®] ZD

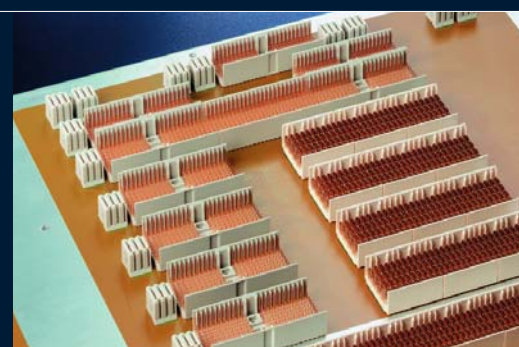
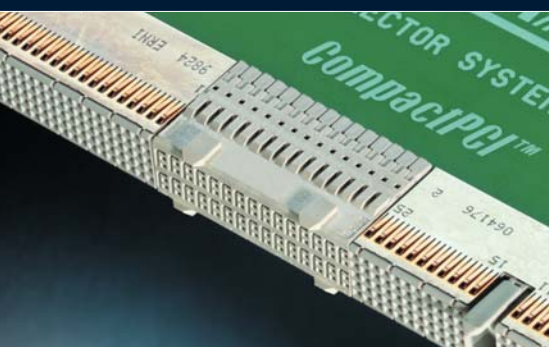

ERmet ZD

High Speed Differential Hard Metric Connector System

Table of Contents



ERmet ZD High Speed Differential Hard Metric Connector System	2
Electrical and Mechanical Characteristics	3
Right Angle Female Connectors 4 Pair	5
Right Angle Female Connectors 4 Pair Ordering Information	6
Right Angle Female Connectors 3 Pair	7
Right Angle Female Connectors 3 Pair Ordering Information	8
Right Angle Female Connectors 2 Pair	9
Right Angle Female Connectors 2 Pair Ordering Information	10
Vertical Male Connectors 4 Pair	11
Vertical Male Connectors 4 Pair Ordering Information	12
Vertical Male 4 Pair Cable Headers	14
Vertical Male 4 Pair Cable Headers Ordering Information	15
Vertical Male Connectors 3 Pair	16
Vertical Male Connectors 3 Pair Ordering Information	17
Vertical Male Connectors 2 Pair	19
Vertical Male Connectors 2 Pair Ordering Information	20
Right Angle Male Connectors 4 Pair	21
Right Angle Male Connectors 4 Pair Ordering Information	22
Right Angle Male Connectors 3 Pair	23
Right Angle Male Connectors 3 Pair Ordering Information	24
Right Angle Male Connectors 2 Pair	25
Right Angle Male Connectors 2 Pair Ordering Information	26
Vertical Female Connectors 4 Pair	27
Vertical Female Connectors 4 Pair Ordering Information	28
Cable System	29
ERmet ZD Cable 5 Wafer	30
ERmet ZD Cable 10 Wafer	31
Cable Assemblies	31
Application Tooling, Equipment and Testing	32
Mating Conditions	34
Recommended PCB Layout	35
Antipad Size	40
Additional Mechanical Features	41
Part Number Index	44

ERmet ZD High Speed Differential Hard Metric Connector System

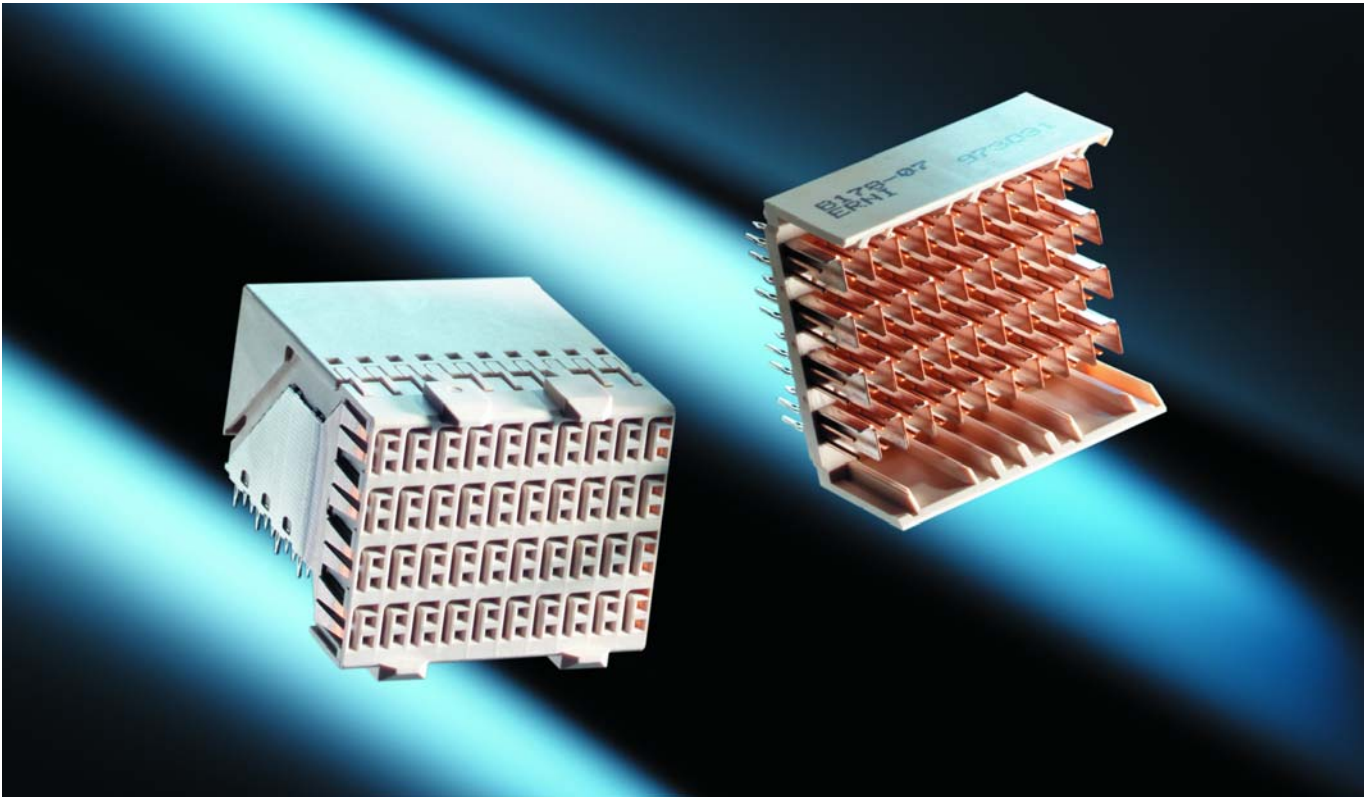

ERmet ZD Male and Female Module with Pressfit Termination

Description

The ERmet ZD is specifically designed for high speed differential signaling in telecom applications at data rates of up to 5 Gbits/second. This robust, high performance, modular connector system is also designed to be used in conjunction with the 2 mm Hard Metric (IEC 61076-4-101) family of connectors. It shares the chassis and board design features along with common layout references.

The connector meets the electrical performance requirements of high speed, low voltage differential signaling. The ERmet ZD connector family is available in pressfit versions. The back-plane module is a male pin header that has three mating levels. The ground shield and signal pins mate sequentially at 1.5 mm intervals.

The robust mechanical design and excellent signal integrity are a result of the internal differential shielding scheme and the “L” shaped male shield blades. The inherently rigid male shields stand higher than the signal pins and surround each pair. An improved guidance feature completes the rugged mechanical design.

Optimized grid design to improve the RF characteristics.

Easy and economical trace routing achieved by in-line-design of signal and ground pins.

Simulation models available upon request.

Technical Features

- Design: Wafers with individually shielded pairs of contacts.
- Contacts: Low noise, dual beam, leaf contacts with one ground blade for every pair of signals.
- Wafer pitch: 2.5 mm from wafer to wafer.
- Pitch between signal pins: 1.5 mm between pairs (within wafer).
- Pitch between pairs: 4.5 mm (within wafer).
- Ground arrangement: In line with signals at termination and surrounding shield.
- Multiline Crosstalk < 3% at 100 ps
- Differential Impedance: $100 \Omega \pm 10\%$
- Power Modules: Closed entry, vertical female backplane modules with stamped blades.
- Alignment Features: Improved pre-alignment guide and polarizing features, 4 rigid blades for all modules.
- Modularity: Modules are available in two widths and a variety of lengths to integrate within typical Eurocard designs utilizing 5 and 8 row, 2 mm HM connectors to IEC 61076-4-101.

ERmet ZD

High Speed Differential Hard Metric Connector System

Electrical and Mechanical Characteristics



	Standard	Pressfit Male- and Female
Number of pins		2-, 3- and 4-pair
Technical data		
Climate category	DIN EN 60068-1 test b	-55/125/56
Temperature range		-55/125 °C
Current rating	IEC60512 test 5b	By ambient temperature: 20 °C 0.9 A 70 °C 0.7 A 100 °C 0.4 A
Clearance and creepage distance		0.5 mm
Voltage rating	IEC 60664	Has to be determined according to client-specific using case (degree of environmental pollution) according to IEC 60664
Dielectric strength	IEC 60512 test 4a	contact pair - contact pair 500 V _{rms} contact pair - shield 500 V _{rms}
Contact resistance	IEC 60512 test 2a	< 50 mΩ (Signal) < 15 mΩ (Shield)
Insulation resistance	IEC 60512 test 3a	> 10 ⁴ MΩ
Vibration, sine	IEC 60512 test 6d	10 – 2000 Hz 20 g
Contact interruption (while vibration test)	IEC 60512 test 2e	< 1 μs
Shock, halfsine	IEC 60512 test 6c	50 g 11 ms
Contact interruption (while shock test)	IEC 60512 test 2e	< 1 μs
Mechanical operation (mating cycles)	IEC 60512 test 9a	> 250 mating cycles
Insertion and withdrawal force	IEC 60512 test 13b	Insertion force: max. 0.7 N/pin (Signal) max. 0.9 N/pin (Shield) Withdrawal force: min. 0.15 N/pin
Gauge retention force	IEC 60512 test 16e	> 0.2 N

ERmet ZD

High Speed Differential Hard Metric Connector System

Electrical and Mechanical Characteristics



	Standard	Pressfit Male- and Female
Number of pins		2-, 3- and 4-pair
Signal transmission data		
Multiline Crosstalk		< 3% at 100 ps
Insertion Loss		< 1 dB up to 3 GHz
Differential impedance		100 Ω \pm 10%
Propagation delay		A pin 97 \pm 10 ps B pin 107 \pm 10 ps C pin 125 \pm 10 ps D pin 134 \pm 10 ps E pin 157 \pm 10 ps F pin 166 \pm 10 ps G pin 187 \pm 10 ps H pin 199 \pm 10 ps
Process-conditions		
Press-in force		36 N/pin
Warning		Soldering of pressfit connectors not recommended.
Materials		
Housing: Plastic material (symbol)		LCP
CTI value	IEC 112	CTI 175
UL flame rating		UL 94 V-0
UL file		E83005
Contact and mating area		
Base material		Cu alloy
Plating		min. 0.65 μ m PdNi + 0.1 μ m Au over 2 - 3 μ m Ni 0.76 μ m Au over 1.27 μ m Ni (Right Angle Male RoHS 5/6)
Termination area		
Base material		Cu alloy
Plating		0.5 - 2 μ m Sn matt over 2 - 3 μ m Ni 0.5 μ m SnPb over 1.27 μ m Ni (Right Angle Male RoHS 5/6)
Environment compatibility		
Recycling		no flame-retardent additives, no toxic additives, allow easy recycling
Product-approval		
UL		E84703

ERmet ZD

High Speed Differential Hard Metric Connector System

Right Angle Female Connectors 4 Pair

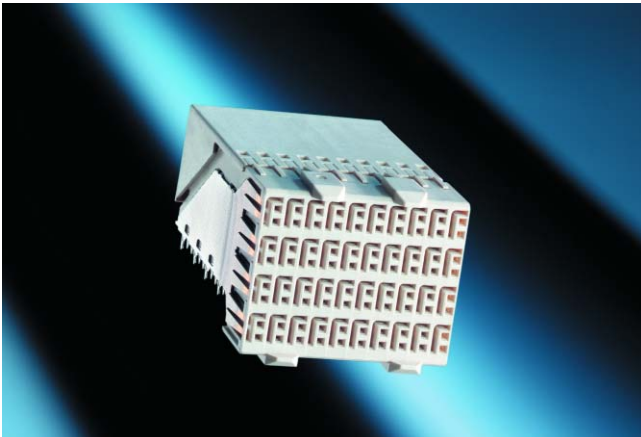

The ERmet ZD 4 pair female connector provides in the 10 wafer version 40 contact pairs (80 signal contacts and 40 ground contacts).

The female pair 4 is available with pressfit termination. Additionally, the ERmet ZD 4 pair female connector has four pre-alignment pegs which provide easier alignment, improved rigidity and reliable polarisation. The layout grid facilitates integration with conventional 2 mm HM (IEC 061076-4-101) connectors.

Dimensional Drawing

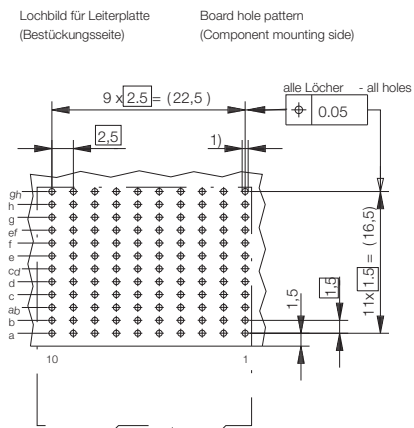
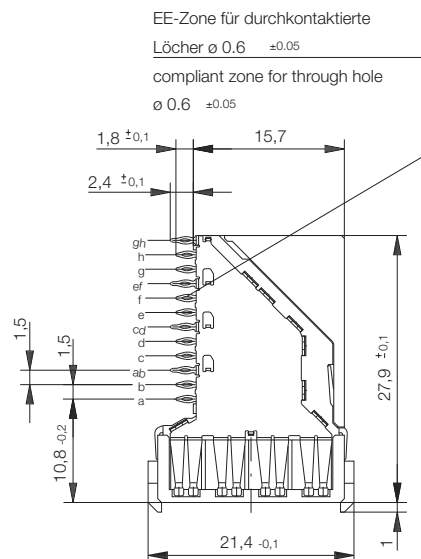
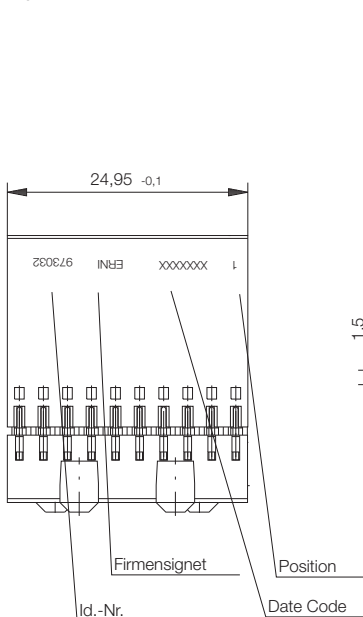
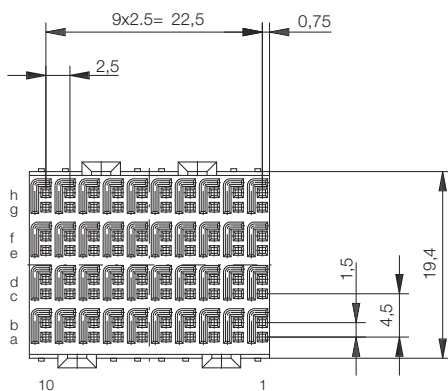

- 1) $\phi 0.6 \pm 0.05$ Durchmesser des metallisierten Loches
 $\phi 0.6 \pm 0.05$ Diameter of finished plated-through hole
- $\phi 0.7 \pm 0.02$ Bohrungsdurchmesser des Loches
 $\phi 0.7 \pm 0.02$ Diameter of drilled hole

All dimensions in mm



ERmet ZD

High Speed Differential Hard Metric Connector System

Right Angle Female Connectors 4 Pair

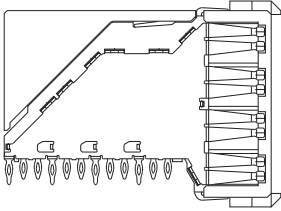

Ordering Information

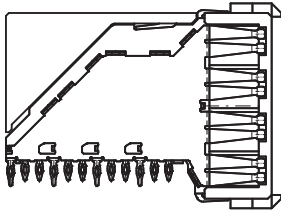
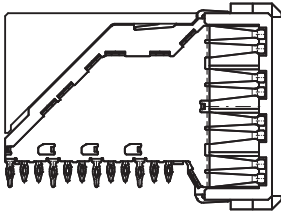
Configuration	Length	Pin Configuration	Termination	Termination Tail Length	Used For	No. of Pins	Part Number
 4 Pair / 10 wafers	25 mm	40 pairs - 80 signals / 40 grounds	 Pressfit	1.8 mm	Zone 2	120	973032
 4 Pair / 12 wafers	30 mm	48 pairs - 96 signals / 48 grounds	Pressfit	1.8 mm	–	144	973099 *
 4 Pair / 15 wafers	37.5 mm	60 pairs - 120 signals / 60 grounds	Pressfit	1.8 mm		180	973024 *

* Parts available as kit.

ERmet ZD

High Speed Differential Hard Metric Connector System

Right Angle Female Connectors 3 Pair

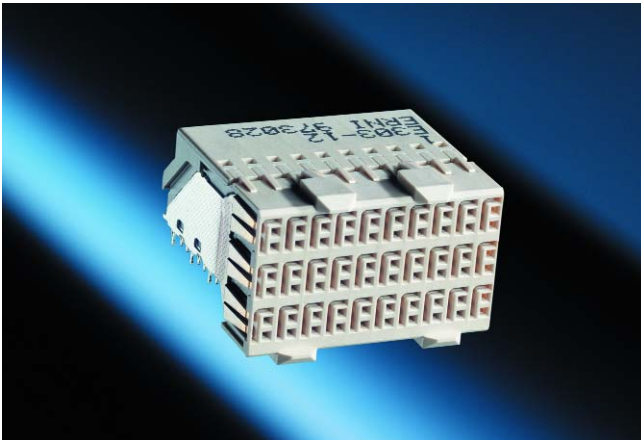

The ERmet ZD 3 pair female connector provides in the 10 wafer version 30 contact pairs (60 signal contacts and 30 ground contacts).

The female 3 pair is available with pressfit termination. Additionally, the ERmet ZD 3 pair female connector has four pre-alignment pegs which provide easier alignment, improved rigidity and reliable polarisation. The layout grid facilitates integration with conventional 2 mm HM (IEC 061076-4-101) connectors.

Dimensional Drawing

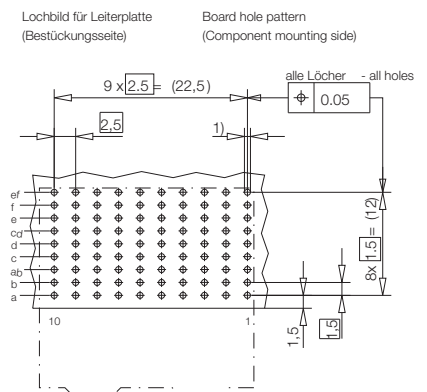
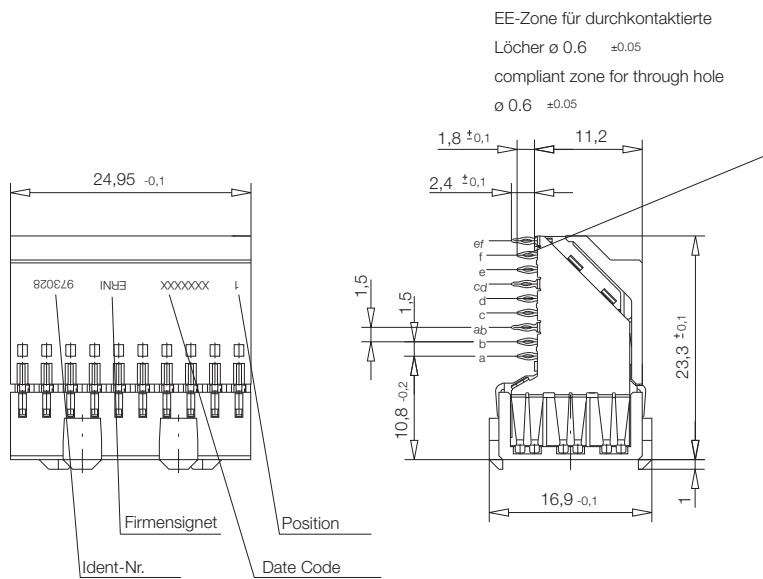
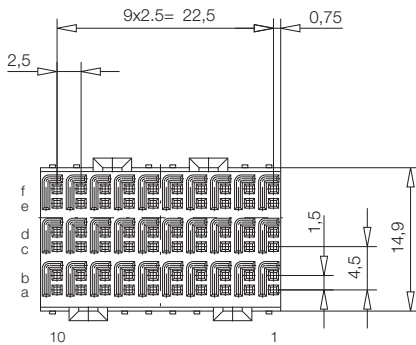



- 1) $\phi 0.6 \pm 0.05$ Durchmesser des metallisierten Loches
 $\phi 0.6 \pm 0.05$ Diameter of finished plated-through hole
- $\phi 0.7 \pm 0.02$ Bohrungsdurchmesser des Loches
 $\phi 0.7 \pm 0.02$ Diameter of drilled hole

All dimensions in mm

ERmet ZD
High Speed Differential Hard Metric Connector System
Right Angle Female Connectors 3 Pair

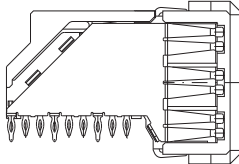

Ordering Information

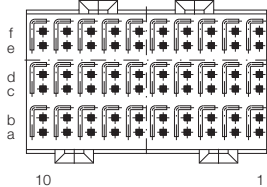
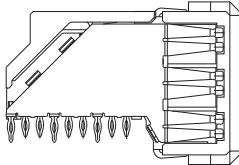
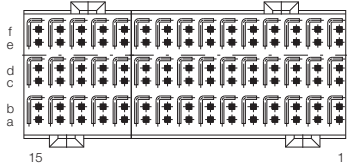
Configuration	Length	Pin Configuration	Termination	Termination Tail Length	Used For	No. of Pins	Part Number
							
3 Pair / 10 wafers	25 mm	30 pairs - 60 signals / 30 grounds	Pressfit	1.8 mm	ADF	90	973028
							
3 Pair / 15 wafers	37.5 mm	45 pairs - 90 signals / 45 grounds	Pressfit	1.8 mm	–	135	973020

ERmet ZD

High Speed Differential Hard Metric Connector System

Right Angle Female Connectors 2 Pair



The ERmet ZD 2 pair female connector provides in the 10 wafer version 20 contact pairs (40 signal contacts and 20 ground contacts).

The female 2 pair is available with pressfit termination. Additionally, the ERmet ZD 2 pair female connector has four pre-alignment pegs which provide easier alignment, improved rigidity and reliable polarisation. The layout grid facilitates integration with conventional 2 mm HM (IEC 061076-4-101) connectors.

Dimensional Drawing

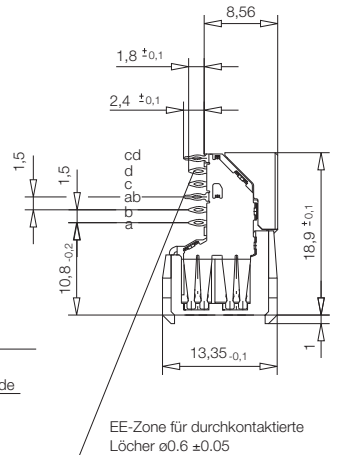
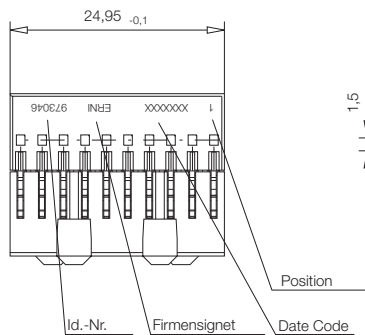
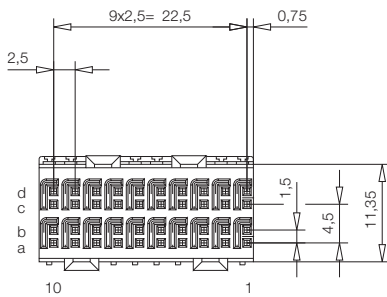

EE-Zone für durchkontaktierte Löcher $\phi 0.6 \pm 0.05$

compliant zone for through hole $\phi 0.6 \pm 0.05$

Lochbild für Leiterplatte (Bestückungsseite) Board hole pattern (Component mounting side)

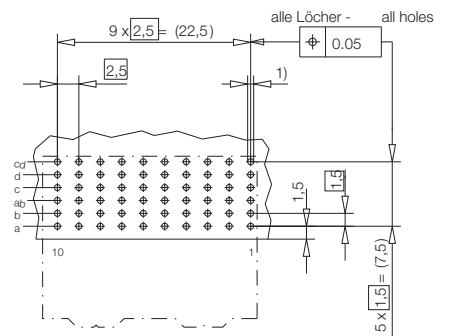

1) $\phi 0.6 \pm 0.05$ Durchmesser des metallisierten Loches
 $\phi 0.6 \pm 0.05$ Diameter of finished plated-through hole

$\phi 0.7 \pm 0.02$ Bohrungsdurchmesser des Loches
 $\phi 0.7 \pm 0.02$ Diameter of drilled hole

All dimensions in mm

ERmet ZD
High Speed Differential Hard Metric Connector System
Right Angle Female Connectors 2 Pair

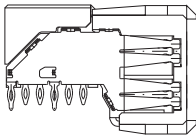
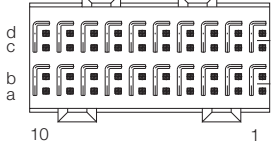

Ordering Information

Configuration	Length	Pin Configuration	Termination	Termination Tail Length	Used For	No. of Pins	Part Number
							
2 pair / 10 wafers	25 mm	20 pairs - 40 signals / 20 grounds	Pressfit	1.8 mm	–	60	973046

ERmet ZD

High Speed Differential Hard Metric Connector System

Vertical Male Connectors 4 Pair



The ERmet ZD 4 pair male connector provides in the 10 wafer version 40 contact pairs (80 signal contacts and 40 ground contacts). This series supports three levels of sequential mating.

The male 4 pair is available with pressfit termination. The "L" shaped shields are robust mechanical structures that provide an ideal differential environment as well as protecting the signal pins and resisting deflection that could cause stubbing. Various module length are offered in four pair wide configuration. The layout grid facilitates integration with conventional 2 mm HM (IEC 061076-4-101) connectors.

Dimensional Drawing

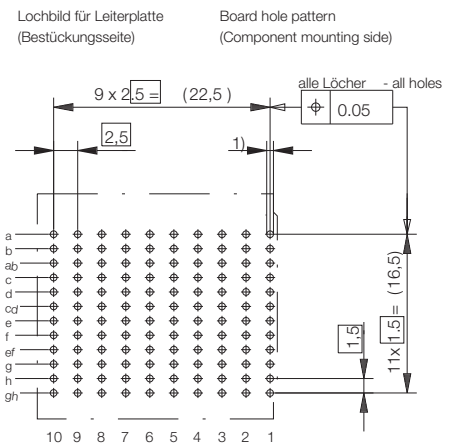
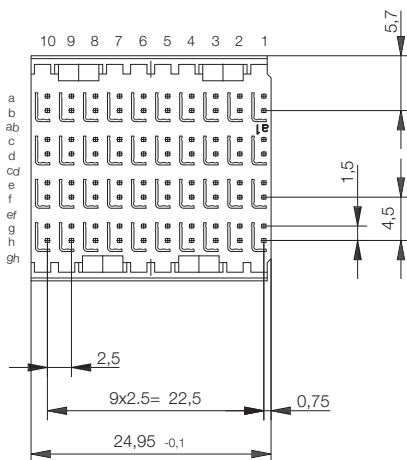
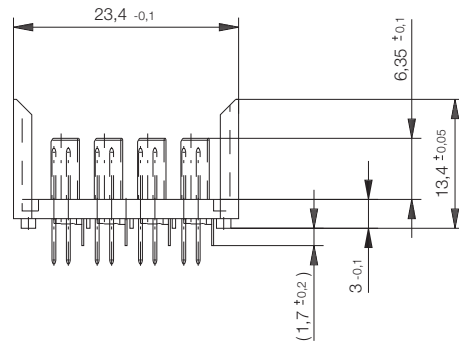
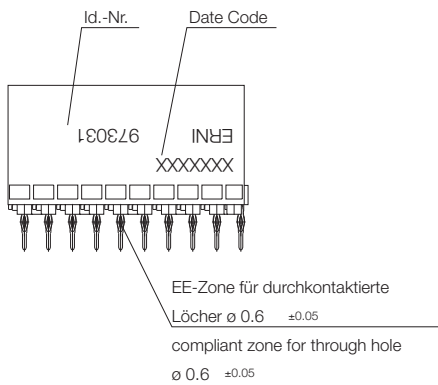

- 1) $\phi 0.6 \pm 0.05$ Durchmesser des metallisierten Loches
 $\phi 0.6 \pm 0.05$ Diameter of finished plated-through hole
- $\phi 0.7 \pm 0.02$ Bohrungsdurchmesser des Loches
 $\phi 0.7 \pm 0.02$ Diameter of drilled hole

All dimensions in mm

ERmet ZD

High Speed Differential Hard Metric Connector System

Vertical Male Connectors 4 Pair

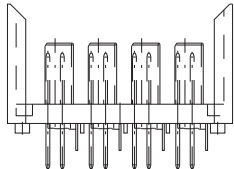
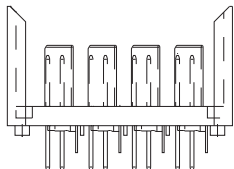

Ordering Information

Configuration	Length	Pin Configuration	Termination	Termination Tail Length	Used For	No. of Pins ERmet	Part Number
	25 mm	40 pairs - 80 signals / 40 grounds	Pressfit	1.7 mm	-	120	973061
	25 mm	40 pairs - 80 signals / 40 grounds	Pressfit	3.7 mm	Zone 2	120	973031
	30 mm	48 pairs - 96 signals / 48 grounds	Pressfit	3.7 mm	-	144	973096

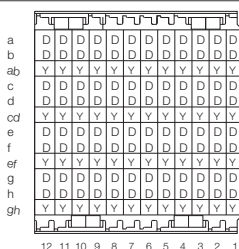
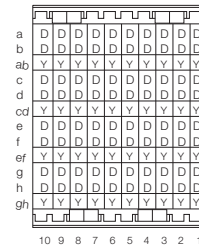
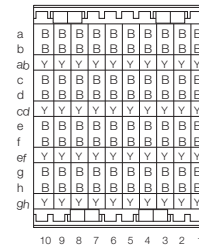

Signal Pins

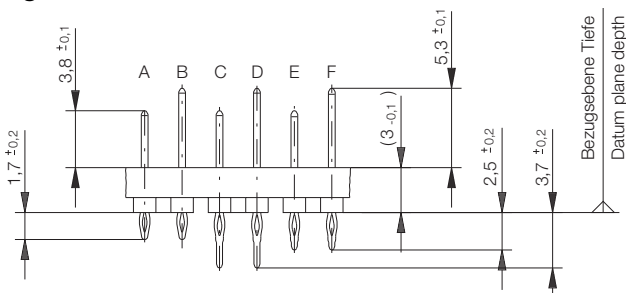

Shielding Pins

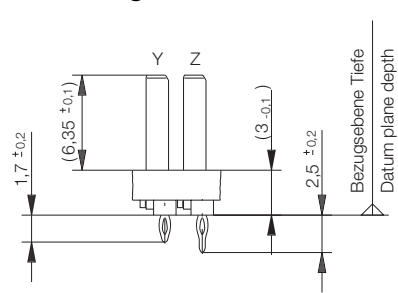

ERmet ZD

High Speed Differential Hard Metric Connector System

Vertical Male Connectors 4 Pair



Ordering Information

Configuration	Length	Pin Configuration	Termination	Termination Tail Length	Used For	No. of Pins	Part Number
4 Pair / 15 wafers	37.5 mm	60 pairs - 120 signals / 60 grounds	Pressfit	3.7 mm	–	180	973023

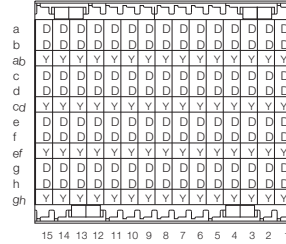
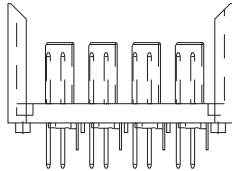

Signal Pins

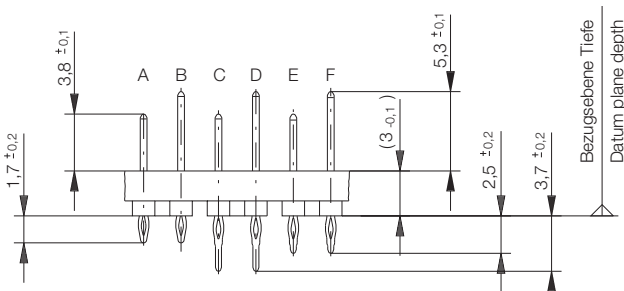

Shielding Pins

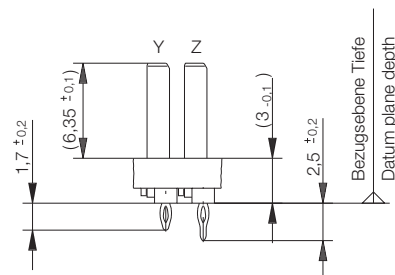

ERmet ZD

High Speed Differential Hard Metric Connector System

Vertical Male 4 Pair Cable Headers

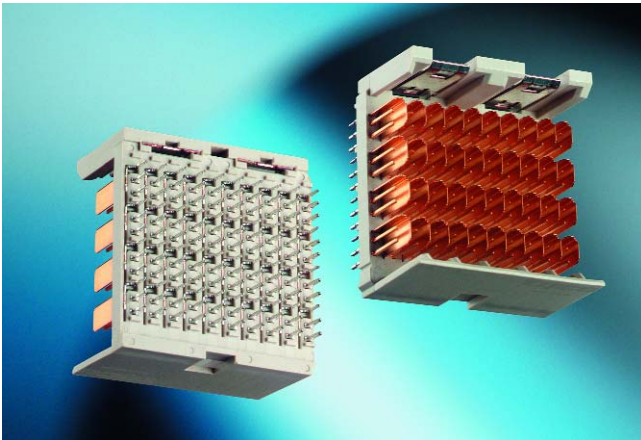

The ERmet ZD cable assembly combines high data rate digital cabling technology with the ERmet ZD high-speed connector to offer an interconnect that delivers high signal fidelity and reliability at backdrill of 5 Gbit/s or higher. The vertical male 4 pair cable header is available with latch for the 5 wafer cable system.

Dimensional Drawing

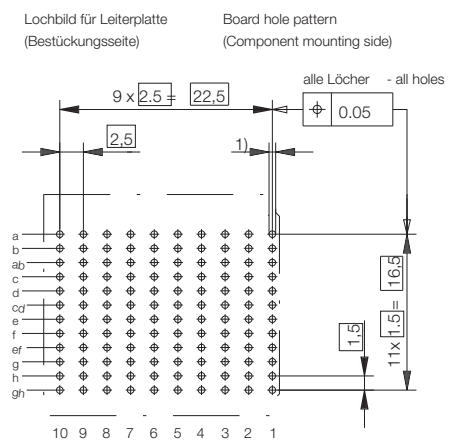
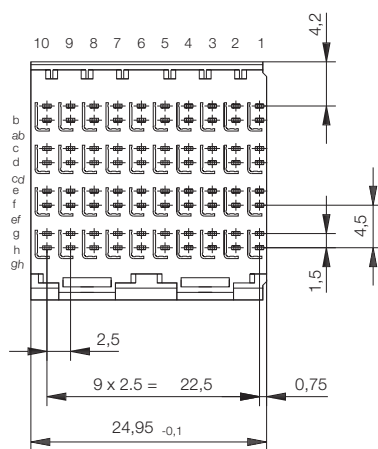
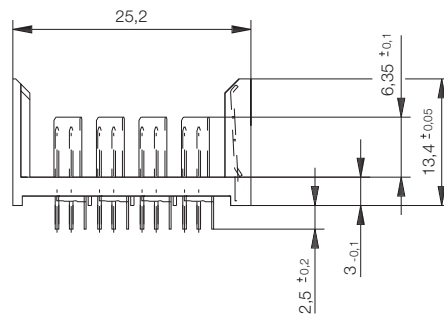
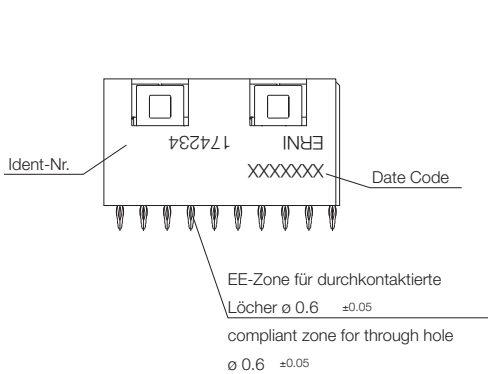

- 1) $\phi 0,6 \pm 0,05$ Durchmesser des metallisierten Loches
 $\phi 0,6 \pm 0,05$ Diameter of finished plated-through hole
- $\phi 0,7 \pm 0,02$ Bohrungsdurchmesser des Loches
 $\phi 0,7 \pm 0,02$ Diameter of drilled hole

All dimensions in mm

ERmet ZD

High Speed Differential Hard Metric Connector System

Vertical Male 4 Pair Cable Headers

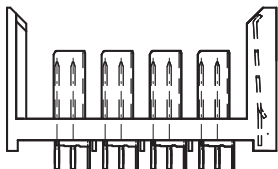
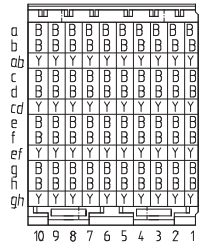
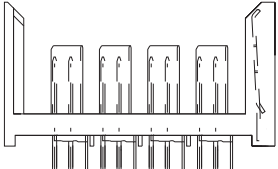
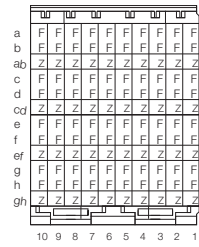

Ordering Information

Configuration	Length	Pin Configuration	Termination	Termination Tail Length	No. of Pins	Part Number
	25 mm		Pressfit	1.7 mm	120	244766
						4 Pair / 10 wafers
	25 mm		Pressfit	2.5 mm	120	174234
						4 Pair / 10 wafers

Signal Pins

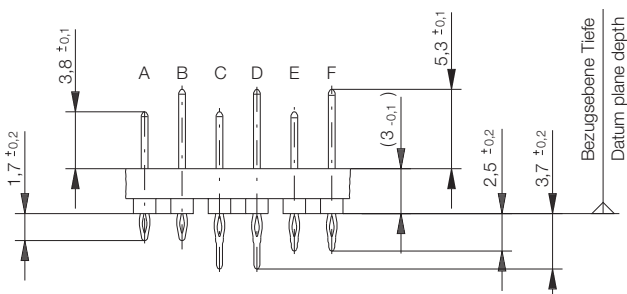

Shielding Pins

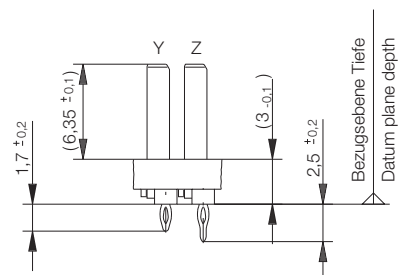

ERmet ZD

High Speed Differential Hard Metric Connector System

Vertical Male Connectors 3 Pair

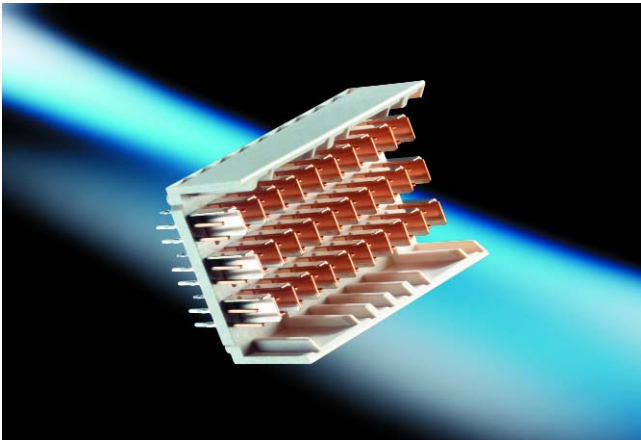

The ERmet ZD 3 pair male connector provides in the 10 wafer version 30 contact pairs (60 signal contacts and 30 ground contacts). This series supports three levels of sequential mating.

The male 3 pair is available with pressfit termination. The "L" shaped shields are robust mechanical structures that provide an ideal differential environment as well as protecting the signal pins and resisting deflection that could cause stubbing. Various module length are offered in three pair wide configuration. The three pair wide version is ideal for Eurocard back-plane designs with 2 mm card spacing.

Dimensional Drawing

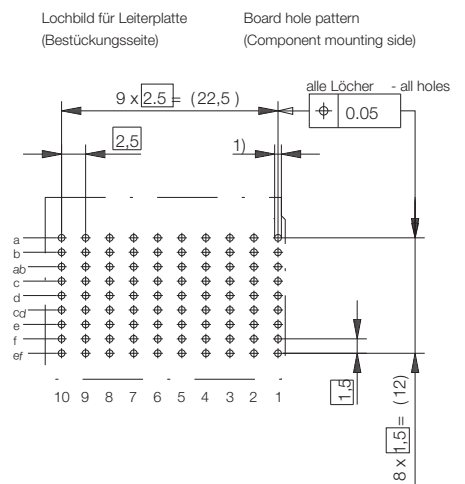
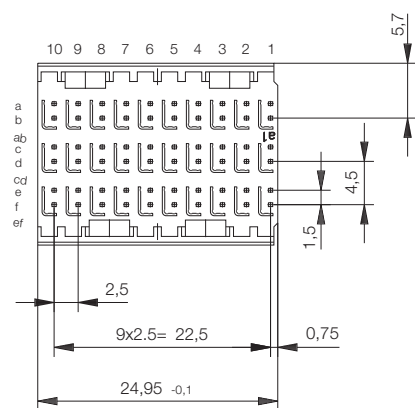
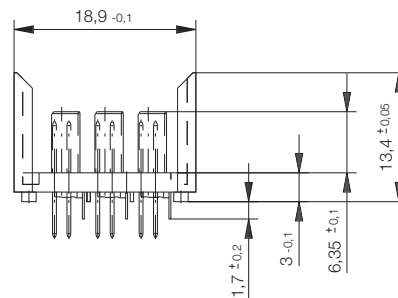
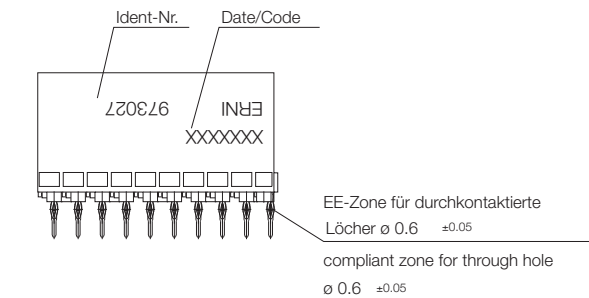

- 1) $\phi 0.6 \pm 0.05$ Durchmesser des metallisierten Loches
 $\phi 0.6 \pm 0.05$ Diameter of finished plated-through hole
- $\phi 0.7 \pm 0.02$ Bohrungsdurchmesser des Loches
 $\phi 0.7 \pm 0.02$ Diameter of drilled hole

All dimensions in mm

ERmet ZD

High Speed Differential Hard Metric Connector System

Vertical Male Connectors 3 Pair



Ordering Information

Configuration	Length	Pin Configuration	Termination	Termination Tail Length	Used For	No. of Pins	Part Number
3 Pair / 15 wafers	37.5 mm	45 pairs - 90 signals / 45 grounds	Pressfit	3.7 mm	–	135	973019

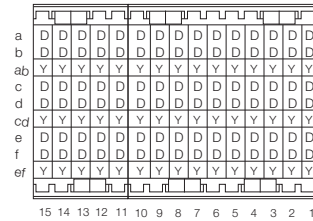
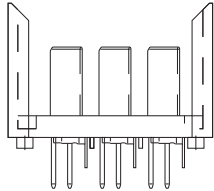

Signal Pins

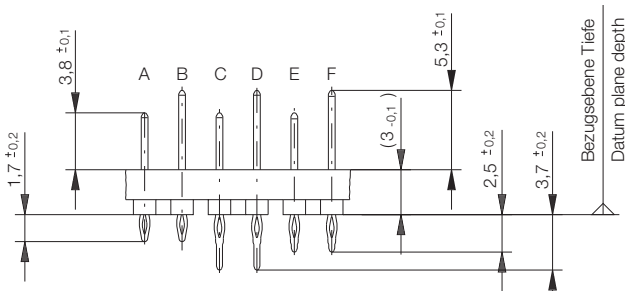

Shielding Pins

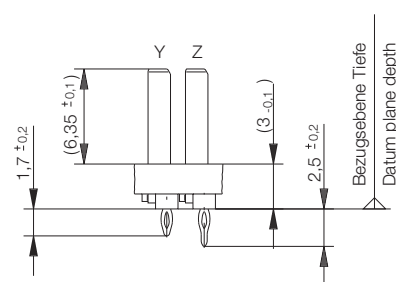

ERmet ZD

High Speed Differential Hard Metric Connector System

Vertical Male Connectors 2 Pair

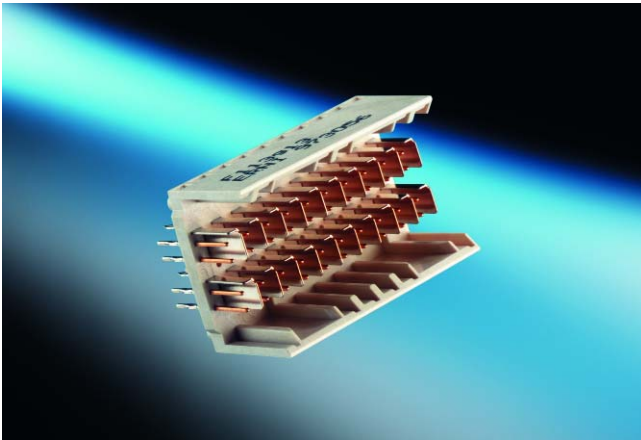

The ERmet ZD 2 pair male connector provides in the 10 wafer version 20 contact pairs (40 signal contacts and 20 ground contacts). This series supports three levels of sequential mating.

The male 2 pair is available with pressfit termination. The "L" shaped shields are robust mechanical structures that provide an ideal differential environment as well as protecting the signal pins and resisting deflection that could cause stubbing. Various module length are offered in two pair wide configuration. The two pair wide version is ideal for applications in combination with ERmet 5+2 connectors because of the same width of 15.4 mm.

Dimensional Drawing

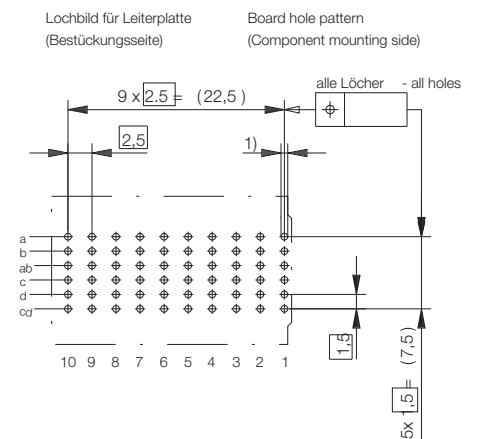
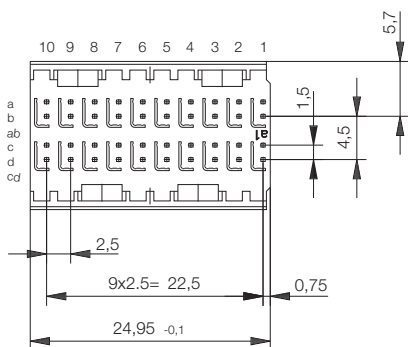
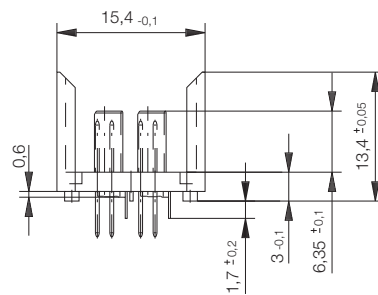
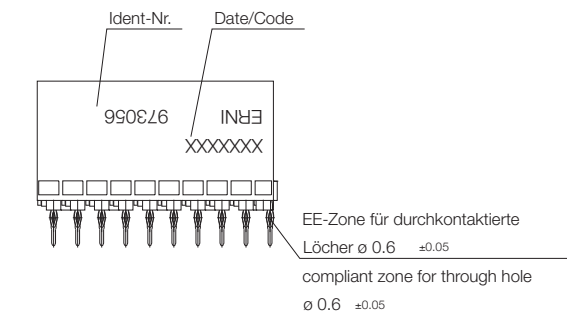

- 1) $\phi 0.6 \pm 0.05$ Durchmesser des metallisierten Loches
 $\phi 0.6 \pm 0.05$ Diameter of finished plated-through hole
- $\phi 0.7 \pm 0.02$ Bohrungsdurchmesser des Loches
 $\phi 0.7 \pm 0.02$ Diameter of drilled hole

All dimensions in mm

ERmet ZD

High Speed Differential Hard Metric Connector System

Vertical Male Connectors 2 Pair



Ordering Information

Configuration	Length	Pin Configuration	Termination	Termination Tail Length	Used For	No. of Pins	Part Number
2 pair / 10 wafers	25 mm	20 pairs - 40 signals / 20 grounds	Pressfit	1.7 mm	–	60	973080
2 pair / 10 wafers	25 mm	20 pairs - 40 signals / 20 grounds	Pressfit	1.7 mm	–	60	973063
2 pair / 10 wafers	25 mm	20 pairs - 40 signals / 20 grounds	Pressfit	3.7 mm	–	60	973056

Signal Pins

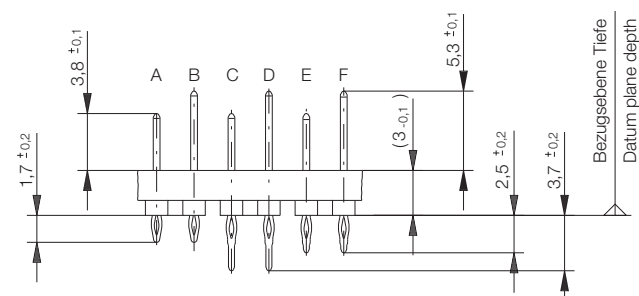

Shielding Pins

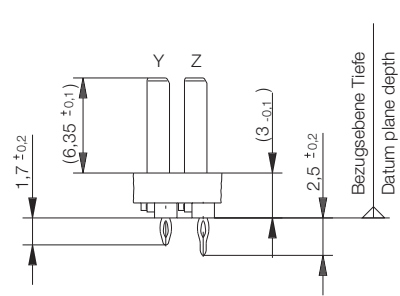

ERmet ZD

High Speed Differential Hard Metric Connector System

Right Angle Male Connectors 4 Pair

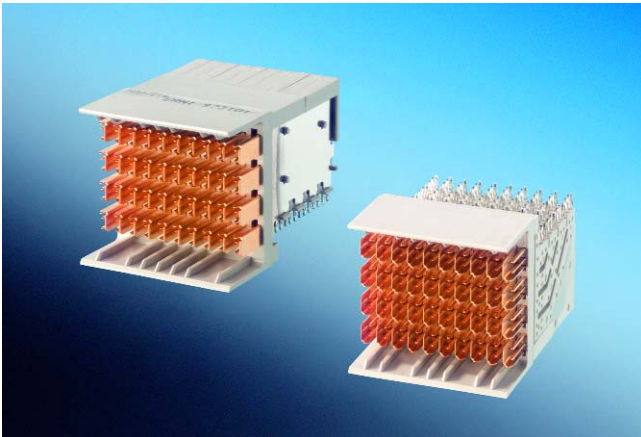

The ERmet ZD 4 pair right angle male connector provides in the 10 wafer version 40 contact pairs and is available with pressfit termination. The connector is designed for high speed differential applications and is an extension of the ERmet 2 mm HM product line.

The 4 pair right angle male connector can be used as an AdvancedTCA® Zone 3 connector in conjunction with the Zone 2 right angle female connector.

Dimensional Drawing

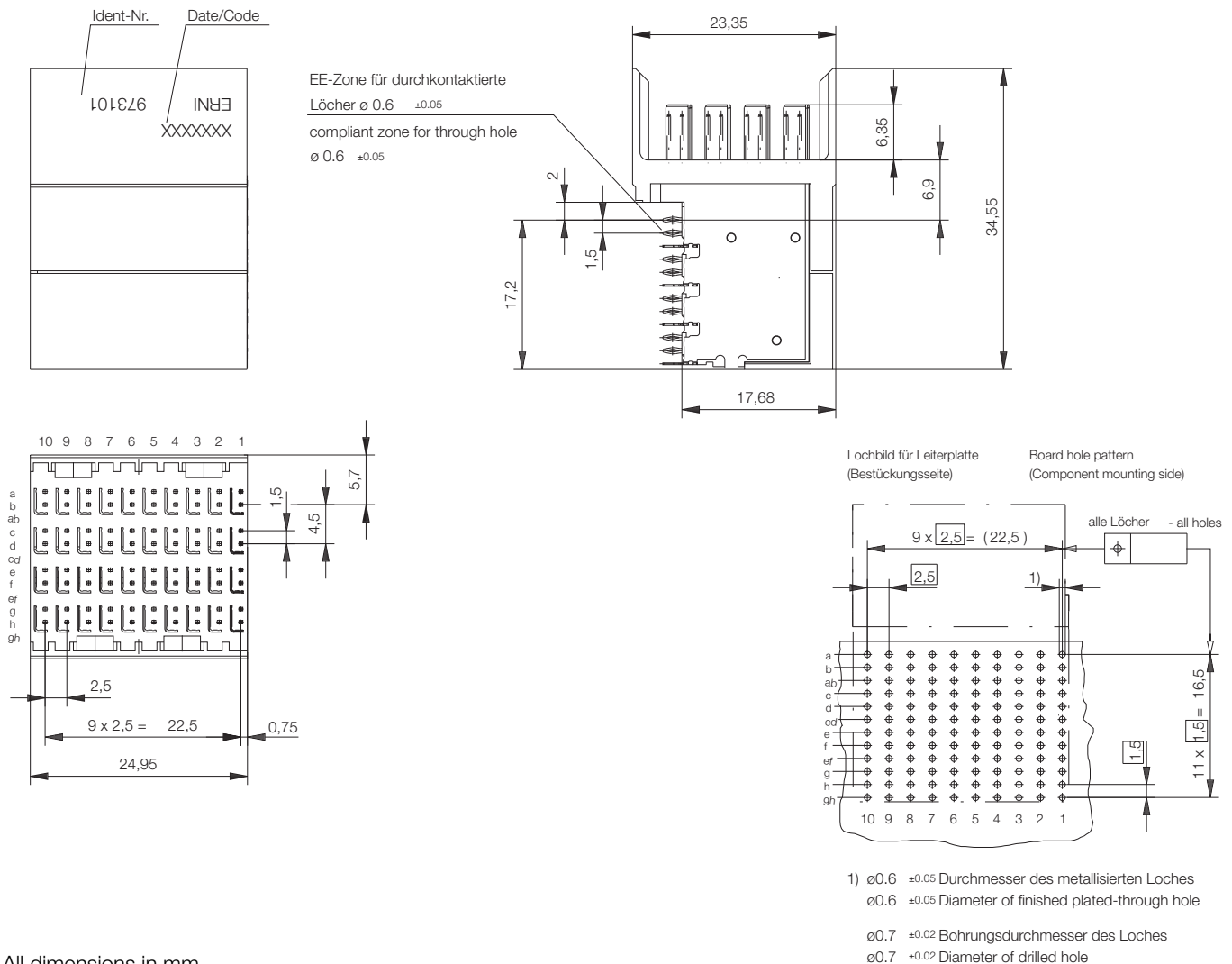

All dimensions in mm

ERmet ZD
High Speed Differential Hard Metric Connector System
Right Angle Male Connectors 4 Pair

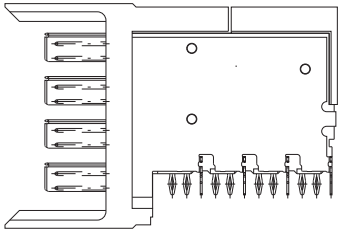
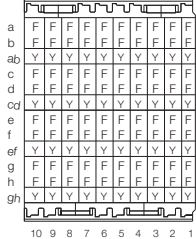

Ordering Information

Configuration	Length	Pin Configuration	Termination	Termination Tail Length	Used For	No. of Pins	Part Number
	25 mm		Pressfit	-	-	120	973101

Signal Pins

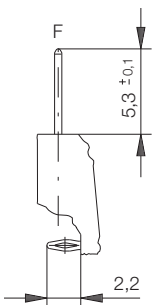

Shielding Pins

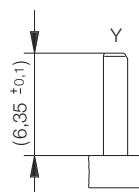

ERmet ZD

High Speed Differential Hard Metric Connector System

Right Angle Male Connectors 3 Pair

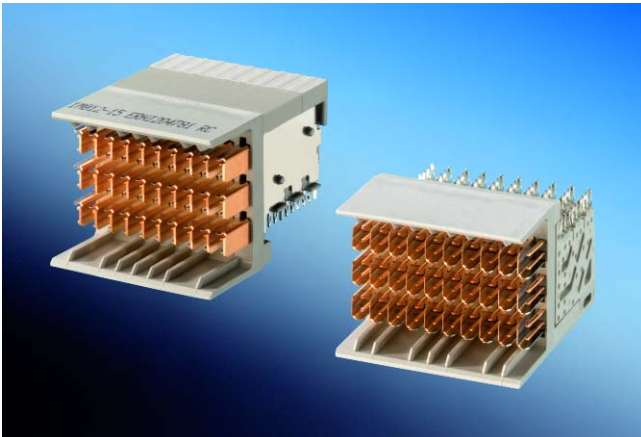

The ERmet ZD 3 pair right angle male connector provides in the 10 wafer version 30 contact pairs and is available with pressfit termination. The connector is designed for high speed differential applications and is an extension of the ERmet 2 mm HM product line.

Dimensional drawings and board hole pattern

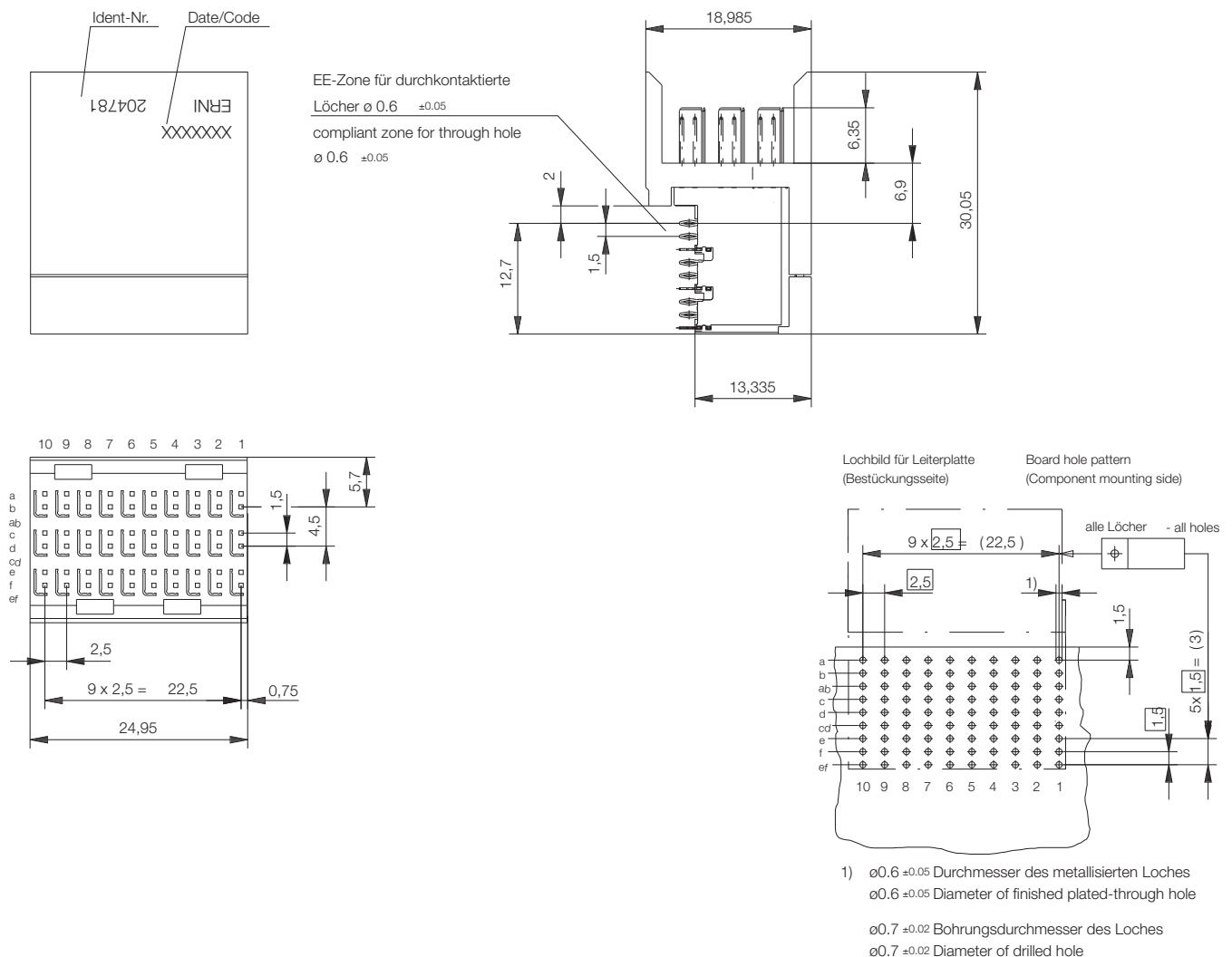

All dimensions in mm

ERmet ZD
High Speed Differential Hard Metric Connector System
Right Angle Male Connectors 3 Pair

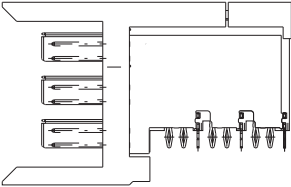
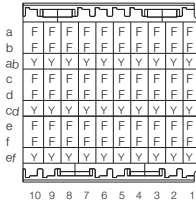

Ordering Information

Configuration	Length	Pin Configuration	Termination	Termination Tail Length	Used For	No. of Pins	Part Number
	25 mm		Pressfit	–	–	90	204781
3 Pair / 10 wafers		30 pairs - 60 signals / 30 grounds					

Signal Pins

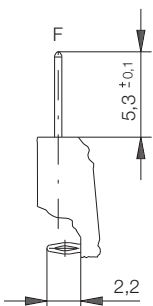

Shielding Pins

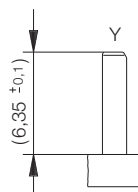

ERmet ZD

High Speed Differential Hard Metric Connector System

Right Angle Male Connectors 2 Pair

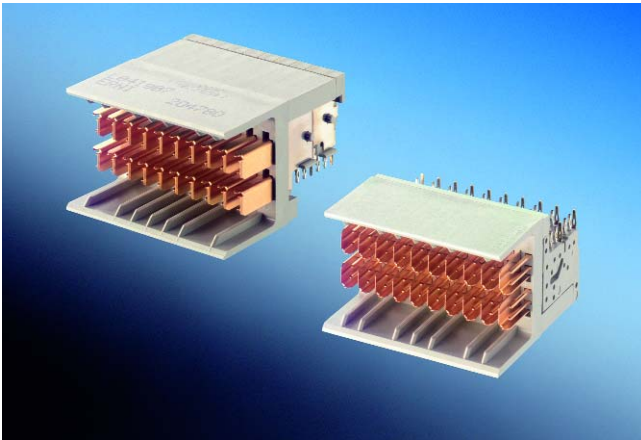

The ERmet ZD 2 pair right angle male connector provides in the 10 wafer version 20 contact pairs and is available with pressfit termination. The connector is designed for high speed differential applications and is an extension of the ERmet 2 mm HM product line.

Dimensional Drawing

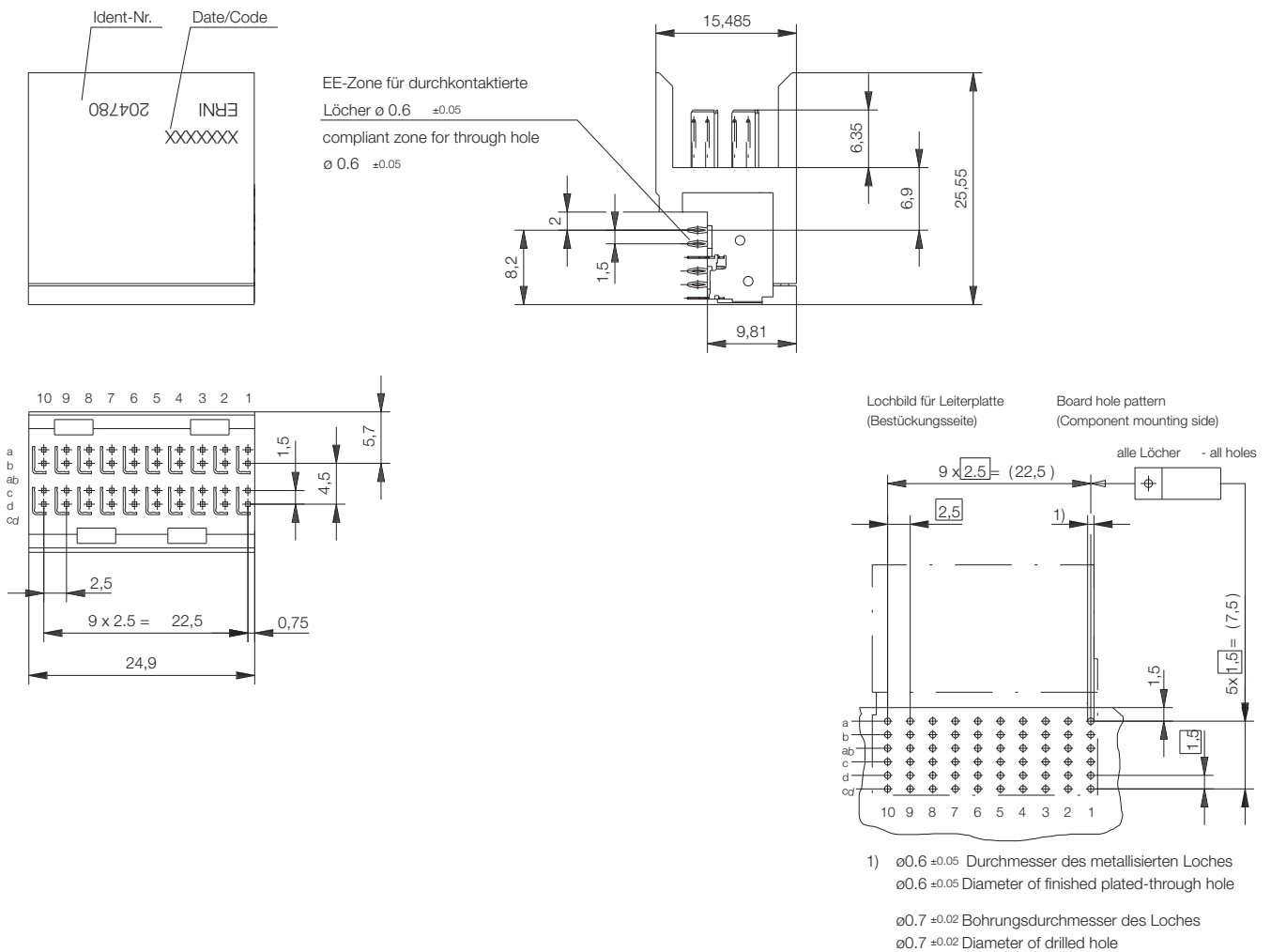

All dimensions in mm

ERmet ZD
High Speed Differential Hard Metric Connector System
Right Angle Male Connectors 2 Pair



Ordering Information

Configuration	Length	Pin Configuration	Termination	Termination Tail Length	Used For	No. of Pins	Part Number
2 pair / 10 wafers	25 mm	20 pairs - 40 signals / 20 grounds	Pressfit	–	–	60	204780

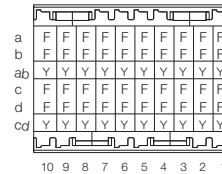
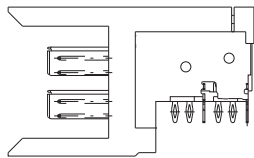

Signal Pins

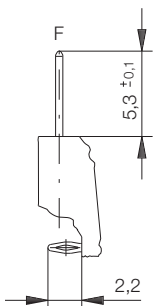

Shielding Pins

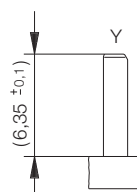

ERmet ZD

High Speed Differential Hard Metric Connector System

Vertical Female Connectors 4 Pair

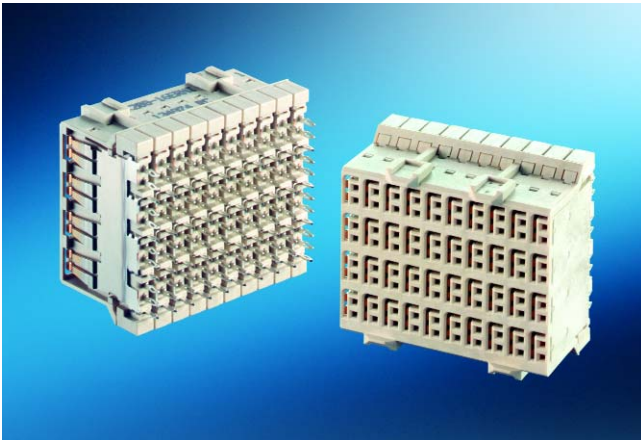

In addition to the four-pair connector modules specified for use in AdvancedTCA® Zone 2, the product line includes two-pair and three-pair signal modules and coplanar connectors. A mezzanine style connector is also available in a four-pair version (vertical female pressfit).

Dimensional Drawing

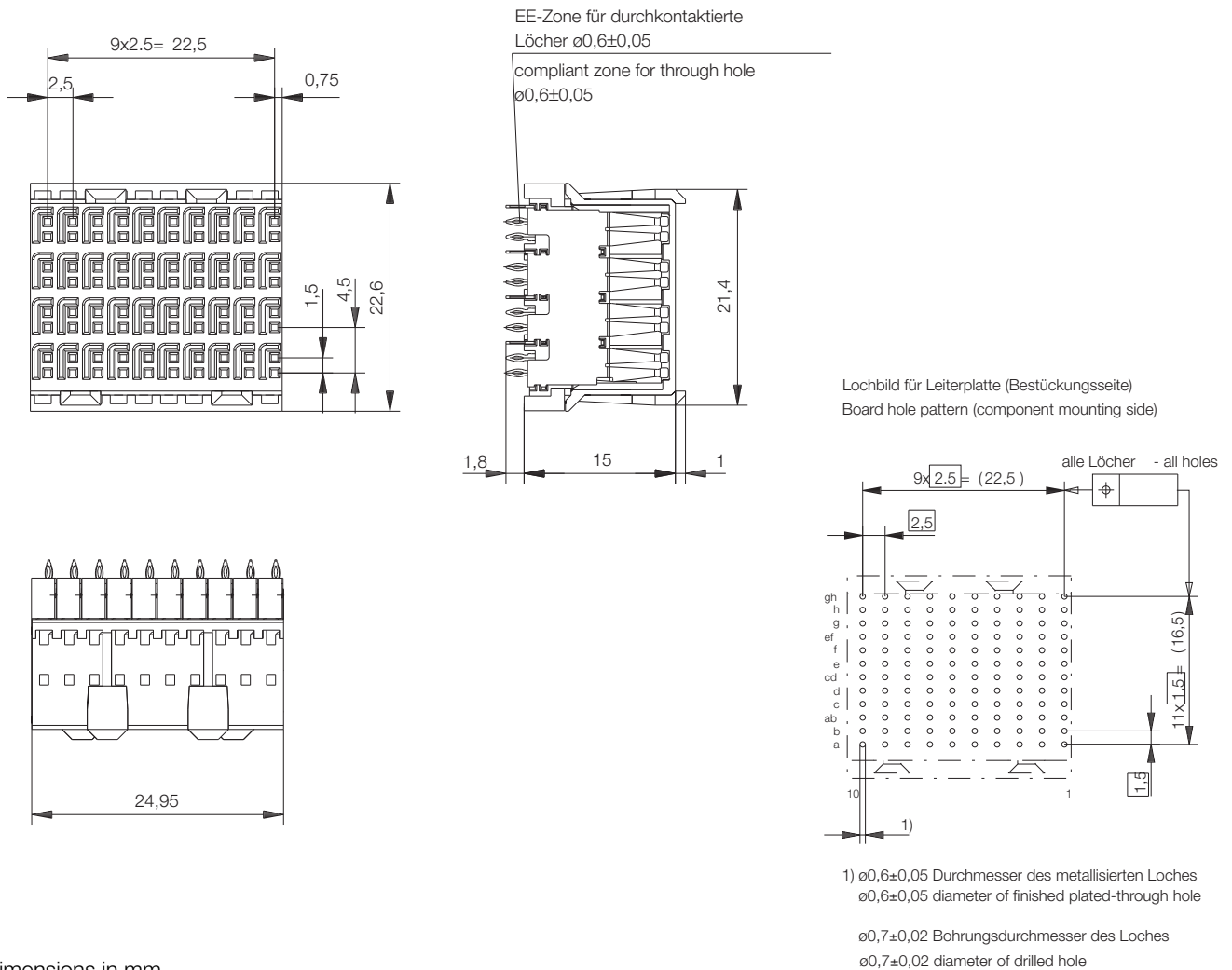

All dimensions in mm

ERmet ZD
High Speed Differential Hard Metric Connector System
Vertical Female Connectors 4 Pair

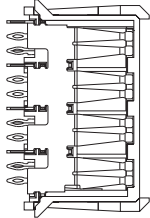
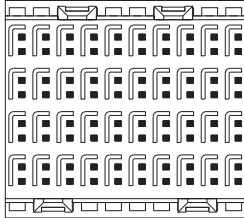
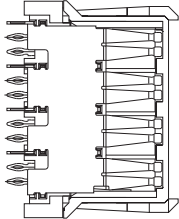
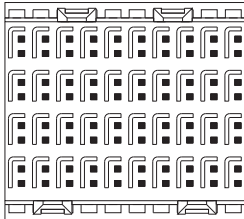

Ordering Information

Configuration	Length	Pin Configuration	Termination	Termination Tail Length	Connector Height *	No. of Pins	Part Number
							
4 Pair / 10 wafers	25 mm	40 pairs - 80 signals / 40 grounds	Pressfit	1.8 mm	12 mm	120	134883
							
4 Pair / 10 wafers	25 mm	40 pairs - 80 signals / 40 grounds	Pressfit	1.8 mm	15 mm	120	134974

* Board-toBoard Distance:

Female Connector Height + Male Connector Height = Board-to-Board Distance

12 mm + 3 mm = 15 mm

15 mm + 3 mm = 18 mm

ERmet ZD

High Speed Differential Hard Metric Connector System

Cable System

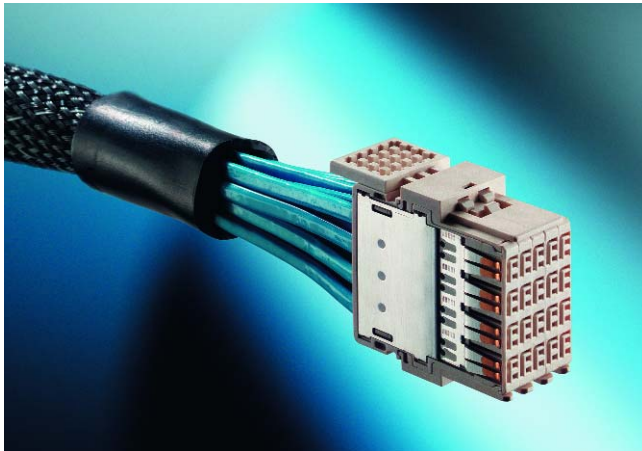

General Information

ERmet ZD Cable Assemblies allow high speed digital signals to be transmitted further and with superior signal fidelity. This connector system has been optimized to transmit high speed differential signals between 2.5 to 10 Gbit/s. ERmet ZD Cable Assemblies come in a variety of different cable sizes, custom pin-out configurations, and are available in either cable or backplane header compatible versions. EMI backshells can also be incorporated to provide a complete interconnect solution for external cabling requirements. This modular interconnect product family has been designated a common platform for interoperability testing by the 10 Gigabit Ethernet Alliance XAU1 Interoperability Group and 10 Gigabit Ethernet Consortium. The connector has also been selected as the backplane interconnect for the PICMG 3.X (ATCA) industry standard.

Features

- Low loss, low crosstalk, low skew
- Controlled impedance through connector
- Optimized grid design for enhanced electrical performance and trace routing
- Integrated polarization, guidance and mechanical latching
- Available versions:
 - 4 pair cable header with latch for 5 wafer cable system
 - 4 pair cable header without latch for 10 wafer cable system

Connector Specifications

- Mating pin length: 3.8 - 5.3 mm
- Operating temperature: -55 °C - +105 °C
- Connector body: Glass filled LCP, UL 94 V-O
- Contacts and Shield: Phosphor Bronze

Mechanical Data

- Mating force: Signal 0.7 N/pin (max.)
Shield 0.9 N/pin (max.)
- Withdrawal force: Signal 0.2 N/pin (max.)
Shield 0.2 N/pin (max.)

Electrical Data

- Current rating: 1.0 A @ 70 °C
- Insulation resistance:
 - Contact pair/Contact pair: 3000 M Ω (min.)
 - Contact pair/Shield: 4000 M Ω (min.)
- Withstanding voltage: 500 V
- Connector impedance: 100 Ω \pm 5 Ω @ 100 ps rise time

Performance level

- Multiline crosstalk: < 5% @ 100 ps rise time, 250 mV swing

ERmet ZD

High Speed Differential Hard Metric Connector System

Cable Assemblies



ERmet ZD Cable 5 Wafer

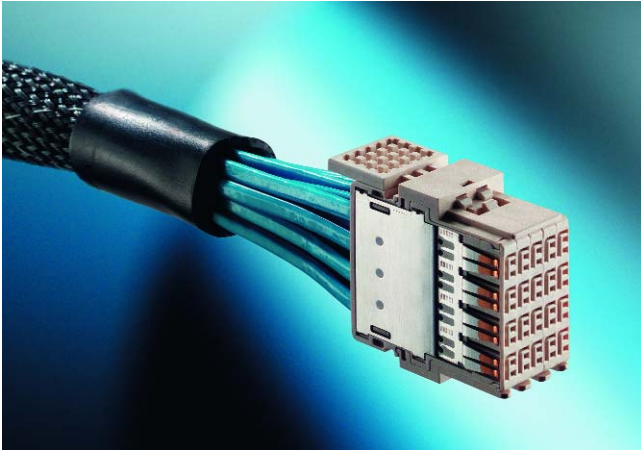

This ERmet ZD cable is used for the 5 wafer cable system. The cables are available with or without latch. For use with Connector 244766 or 174234.

Partnumber Cable System with Latch: **204685**

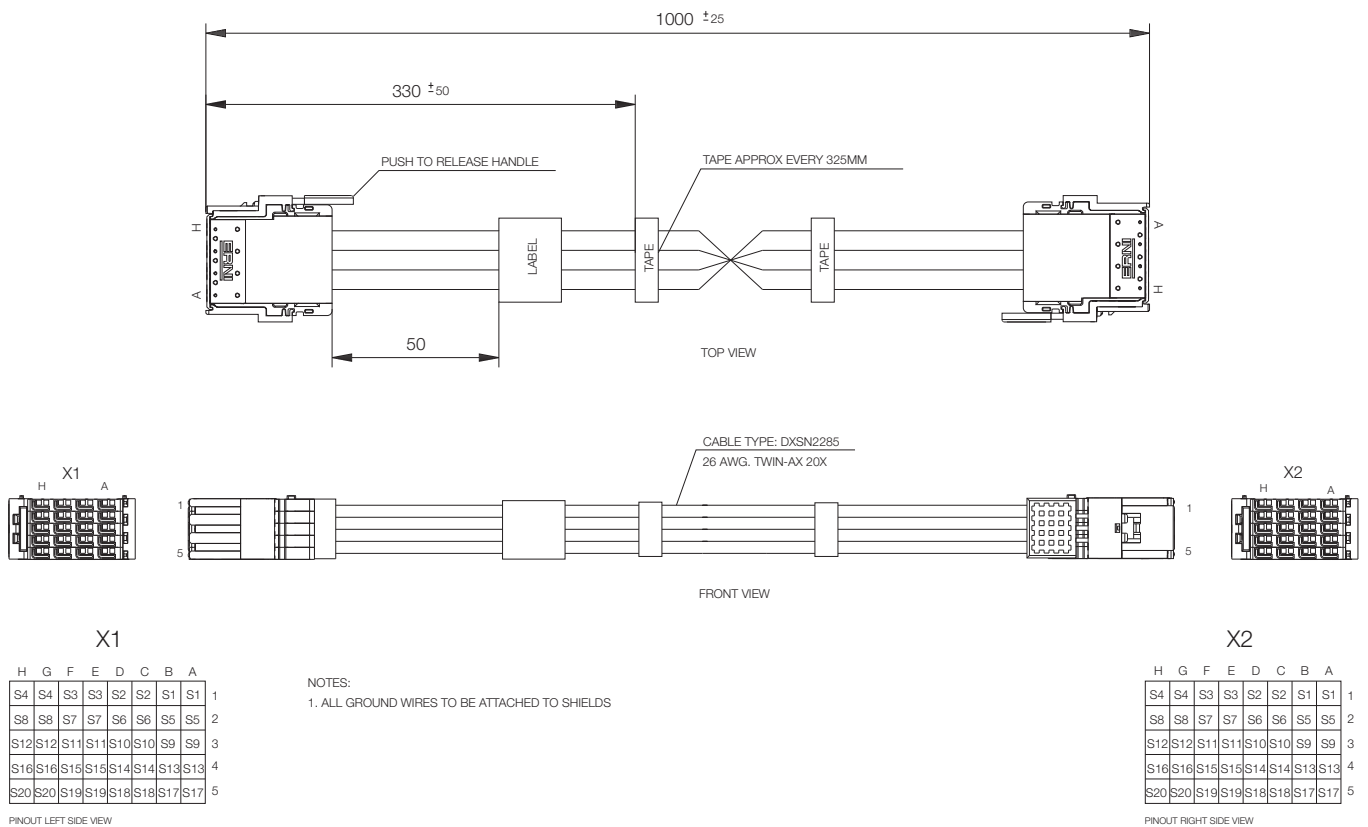

ERmet ZD

High Speed Differential Hard Metric Connector System

Cable Assemblies



ERmet ZD Cable 10 Wafer



This ERmet ZD cable is used for the 10 wafer cable system. For use with Connector 973031 or 973061.

Partnumber Cable System: **223325**

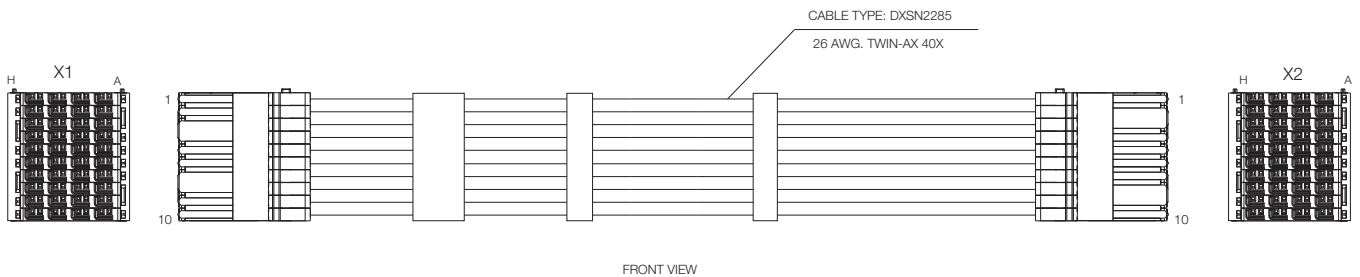
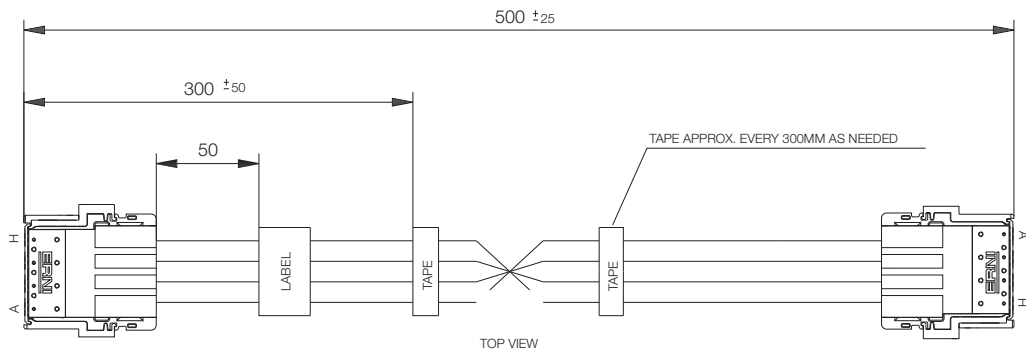

X1

	H	G	F	E	D	C	B	A
1	S1	S1	S2	S2	S3	S3	S4	S4
2	S5	S5	S6	S6	S7	S7	S8	S8
3	S9	S9	S10	S10	S11	S11	S12	S12
4	S13	S13	S14	S14	S15	S15	S16	S16
5	S17	S17	S18	S18	S19	S19	S20	S20
6	S21	S21	S22	S22	S23	S23	S24	S24
7	S25	S25	S26	S26	S27	S27	S28	S28
8	S29	S29	S30	S30	S31	S31	S32	S32
9	S33	S33	S34	S34	S35	S35	S36	S36
10	S37	S37	S38	S38	S39	S39	S40	S40

PINOUT LEFT SIDE VIEW

NOTES:
1. ALL GROUND WIRES TO BE ATTACHED TO SHIELDS

X2

	H	G	F	E	D	C	B	A
1	S1	S1	S2	S2	S3	S3	S4	S4
2	S5	S5	S6	S6	S7	S7	S8	S8
3	S9	S9	S10	S10	S11	S11	S12	S12
4	S13	S13	S14	S14	S15	S15	S16	S16
5	S17	S17	S18	S18	S19	S19	S20	S20
6	S21	S21	S22	S22	S23	S23	S24	S24
7	S25	S25	S26	S26	S27	S27	S28	S28
8	S29	S29	S30	S30	S31	S31	S32	S32
9	S33	S33	S34	S34	S35	S35	S36	S36
10	S37	S37	S38	S38	S39	S39	S40	S40

PINOUT LEFT SIDE VIEW

ERmet ZD

High Speed Differential Hard Metric Connector System

Application Tooling, Equipment and Testing



Evaluation Kits

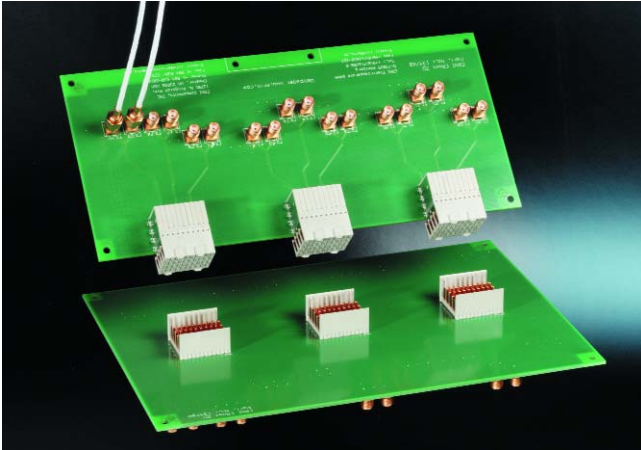

The two evaluation kits, singleline version and multiline version, are developed to measure the signal integrity behavior of the advanced differential pair connector system ERmet ZD. Each evaluation kit contains the test boards and a CD Rom with the description of the measurement set up and relevant technical information. The boards are designed in a manner that allows full de-embedding of the parasitic influence of the transmission lines and the SMA connectors on the board. This ensures properly measured values of the connector system itself without any negative influence of the test fixture. Measurements can be performed with a Time Domain Reflectometer in the Time domain or a Vector Network Analyzer in the frequency domain.

Configuration

The multiline version is specially designed to determine the multiline crosstalk between up to 10 signal pairs and to measure a connector directly at its pins.

Part Number

163211

The singleline version can be used to determine differential impedance of single signal pairs, crosstalk between two signal pairs, transmission and reflection behavior of single pairs and propagation delay of single pairs.

163210

Simulation Models

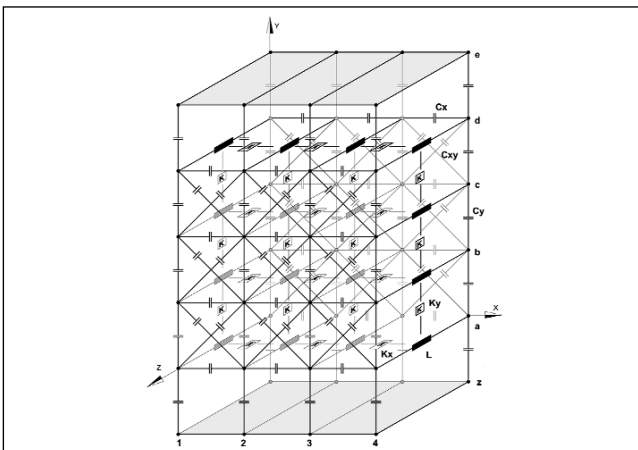

The ERNI ERmet ZD simulation models are provided in two different formats:

1. Spice compatible models based on L, R, C and K elements in accordance to UC Berkeley Spice3f5 standard.
2. S-parameter data in Touchstone file format

For each format, two different types of simulation models are given:

1. A set of very compact models, which represents only one signal pair (e.g. a-b) of the connector. These models should be used, if only the reflection behavior and the impedance matching of the connector should be analyzed. They do not slow down a simulator significantly.

This model is available on the ERNI web page.

2. A set of models which represent 3 wafers of the connector with each wafer containing 2, 3 or 4 signal pairs. This model family fully represents the connector behavior including:

- impedance matching
- crosstalk behavior
- ground bounce

This model is only available when the customer has signed an NDA.

The usage of each model is explained in the header part of the appropriate library file.

Configuration

CD with Simulation Models for the ERmet ZD Connector System

Part Number

144470

ERmet ZD

High Speed Differential Hard Metric Connector System

Application Tooling, Equipment and Testing



Modular Pressfit Tools



ERmet ZD connectors can be end to end mounted in modular layout. To be able to pressfit the selected connector layout for your application in a rationalized way, we have designed the necessary pressfit tools to be modular too. This is true of the tools both for male connectors and for female connectors. The tool bases, also termed anvils, are fixed in a tool holder. Each connector module requires an appropriately sized tool module.

Ordering Information

Connector Type	Wafer	Part Number Upper Tool	Part Number Lower Tool
Right Angle Female Connectors 4 Pair	10	220629	220630
Right Angle Female Connectors 3 Pair	10	220634	220635
Right Angle Female Connectors 2 Pair	10	220637	220638
Verticale Male Connectors 4 Pair	10	220627	220628
Verticale Male Connectors 3 Pair	10	220633	220640
Verticale Male Connectors 2 Pair	10	220636	220639
Right Angle Male Connectors 4 Pair	10	220880	220630
Right Angle Male Connectors 3 Pair	10	220879	220635
Right Angle Male Connectors 2 Pair	10	220895	220638
Verticale Female Connectors 4 Pair	10	220806	220628
Verticale Male 4 Pair Cable Header	10	220758	220628

Repair Instructions

Repair Instructions for male and female connectors available for download under www.erni.com/ERmetZD.

ERmet ZD
High Speed Differential Hard Metric Connector System
Mating Conditions



Misalignment Parameters

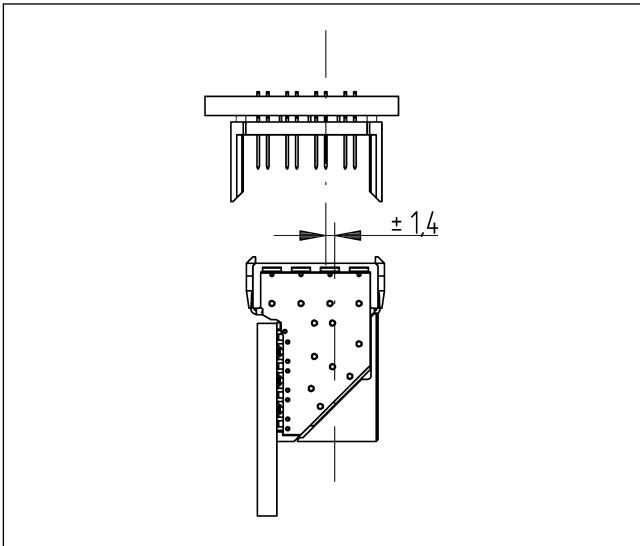

Transverse axis

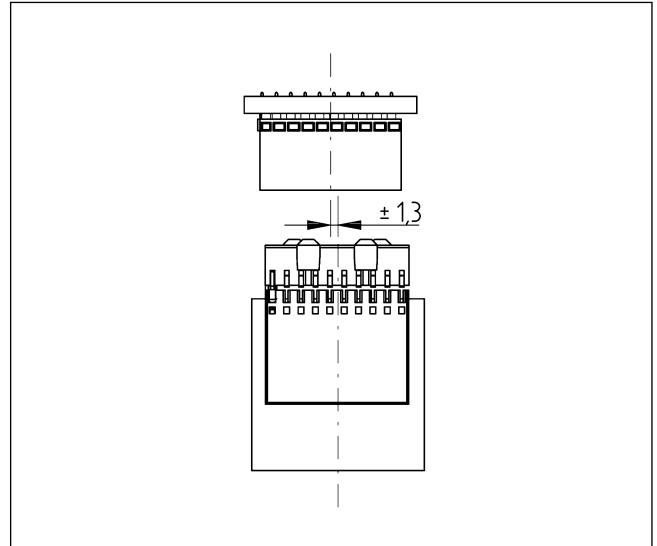

Longitudinal axis

Inclination Parameters

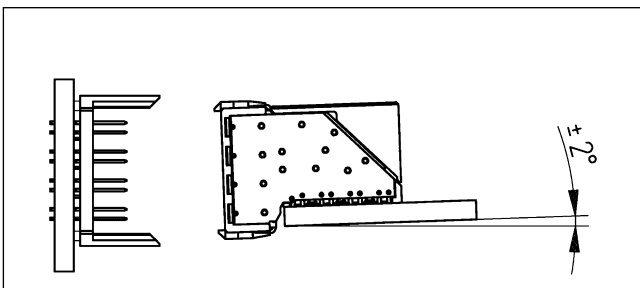

Transverse axis

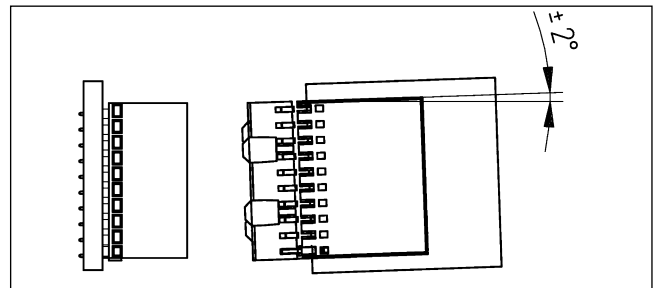

Longitudinal axis

ERmet ZD

High Speed Differential Hard Metric Connector System

Recommended PCB Layout



ERmet ZD Daughtercard and 2 mm HM Connectors

4 Pair

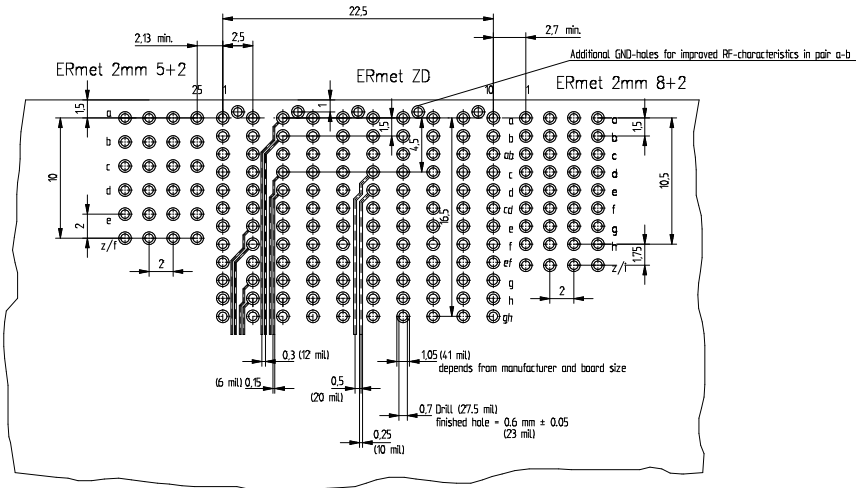

3 Pair

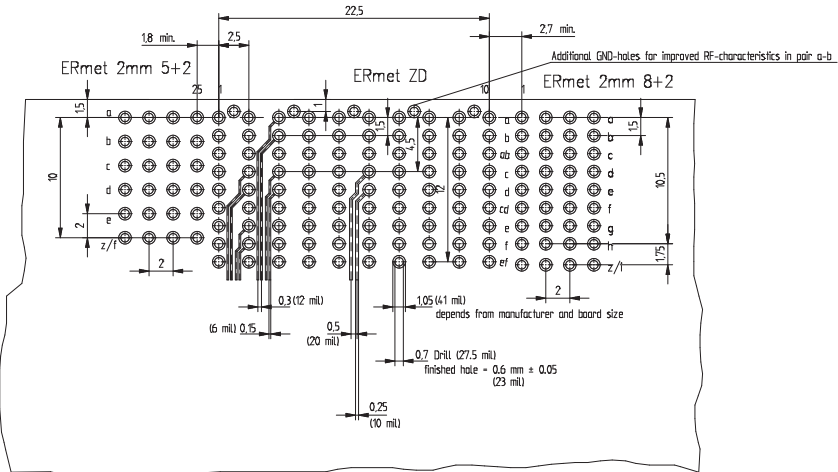

2 Pair

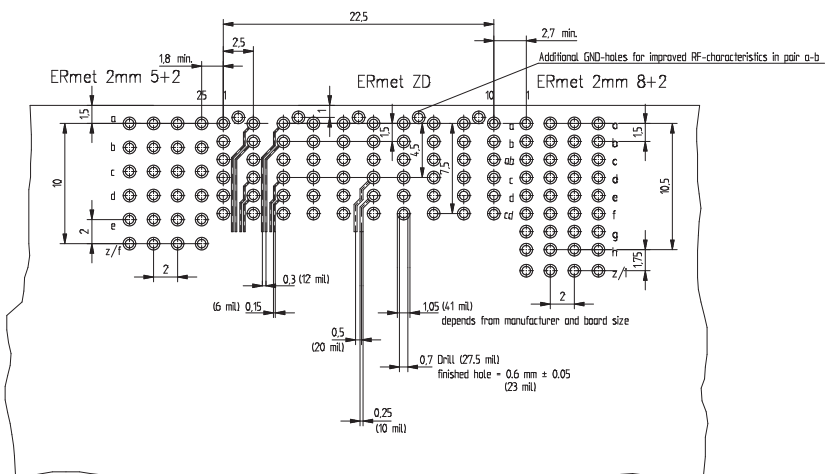

ERmet ZD High Speed Differential Hard Metric Connector System Recommended PCB Layout



ERmet ZD Backplane and 2 mm HM Connectors

4 Pair

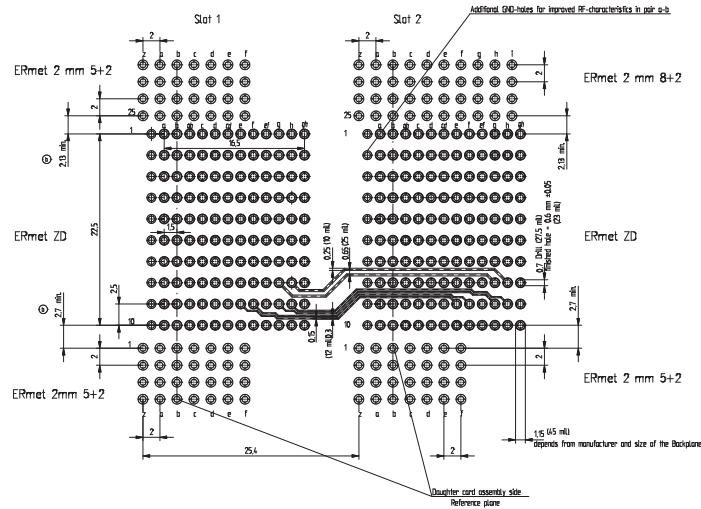

3 Pair

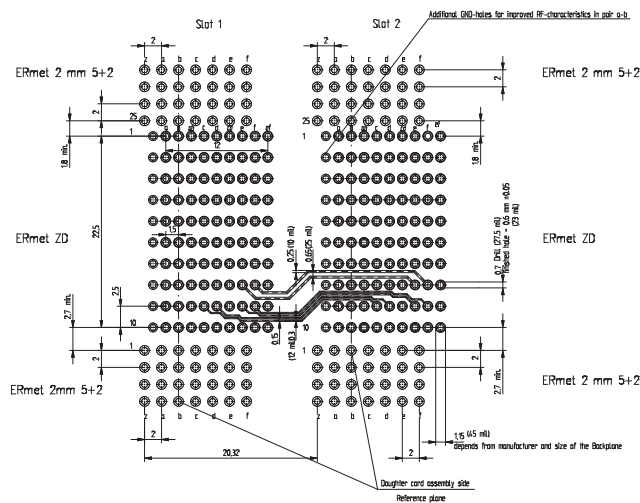

2 Pair

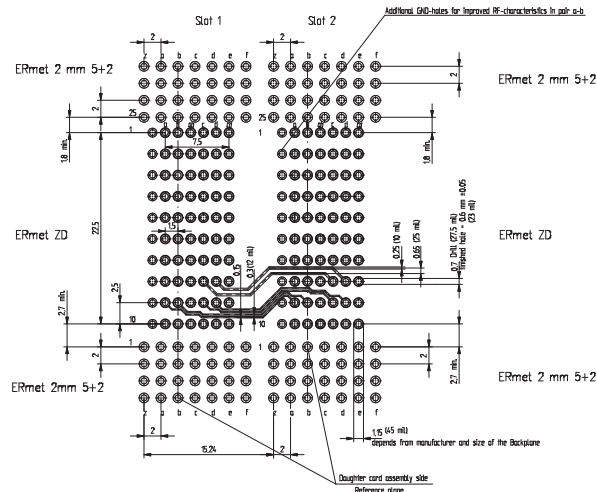

ERmet ZD
High Speed Differential Hard Metric Connector System
Recommended PCB Layout



Midplane Layout

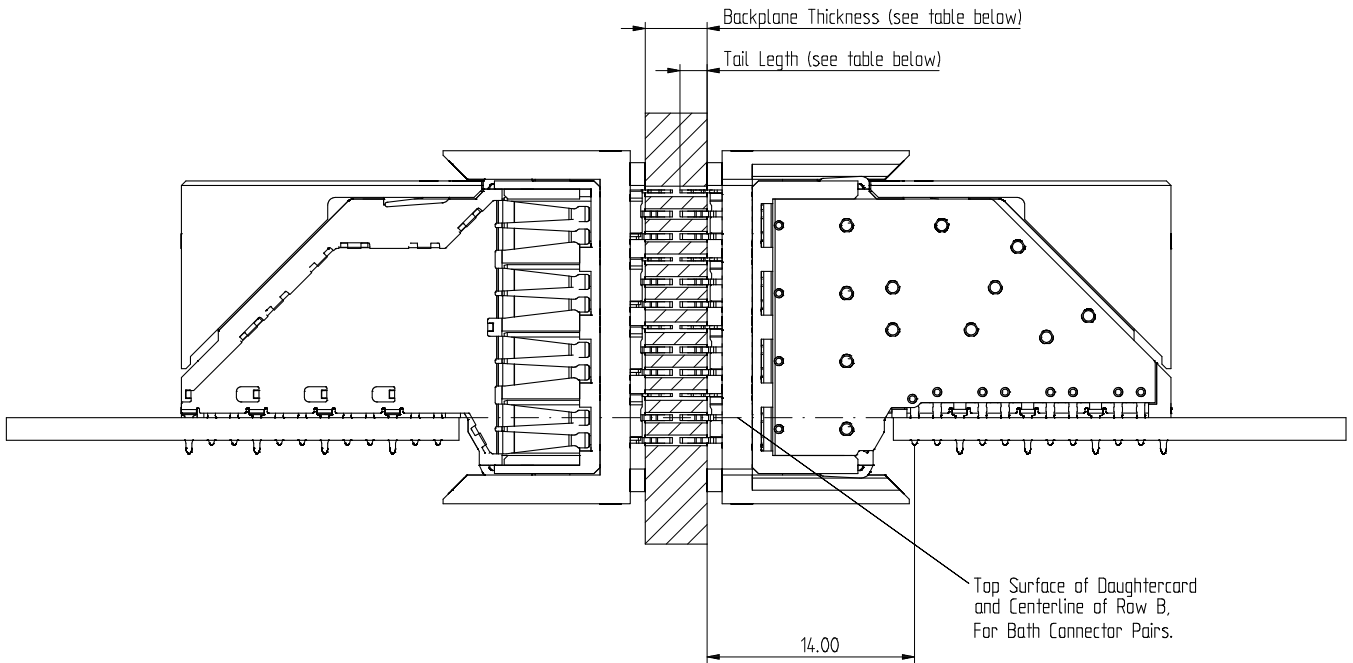

Tail Length	Min. Recommended Backplane Thickness
1.80	4.00
2.50	5.40

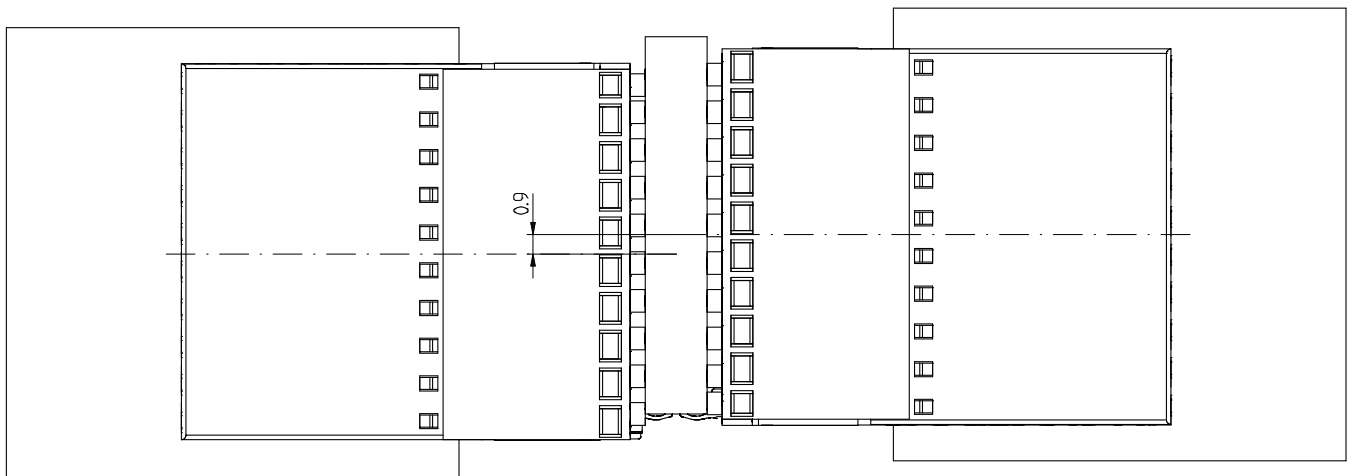

ERmet ZD High Speed Differential Hard Metric Connector System Recommended PCB Layout



ERmet ZD Connector Coplanar

ERmet ZD Right Angle Male

ERmet ZD Right Angle Female

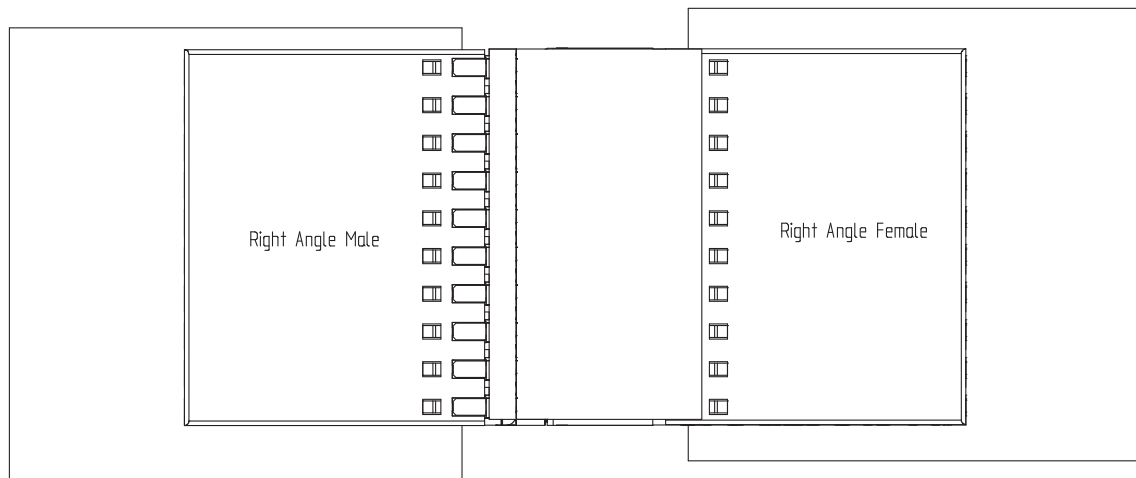
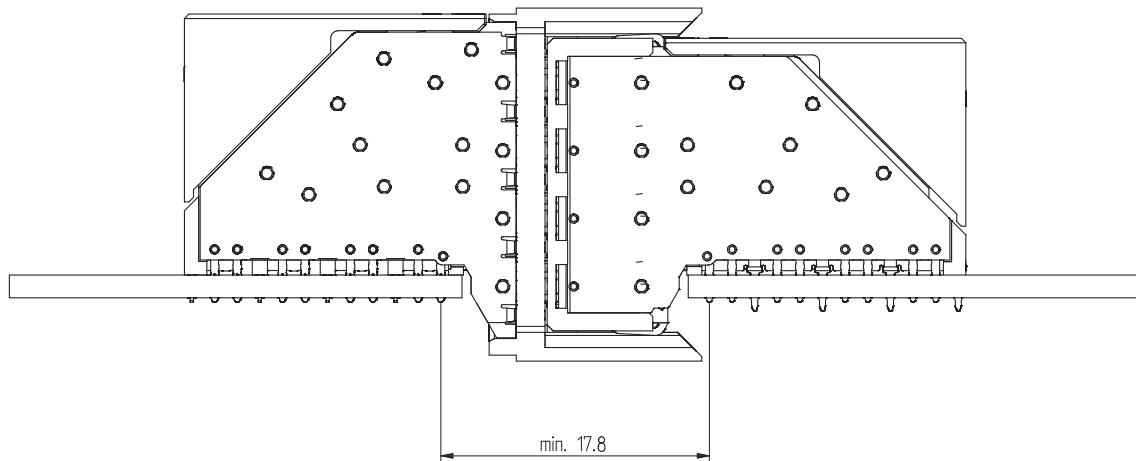

ERmet ZD
High Speed Differential Hard Metric Connector System
Stubbing Effect

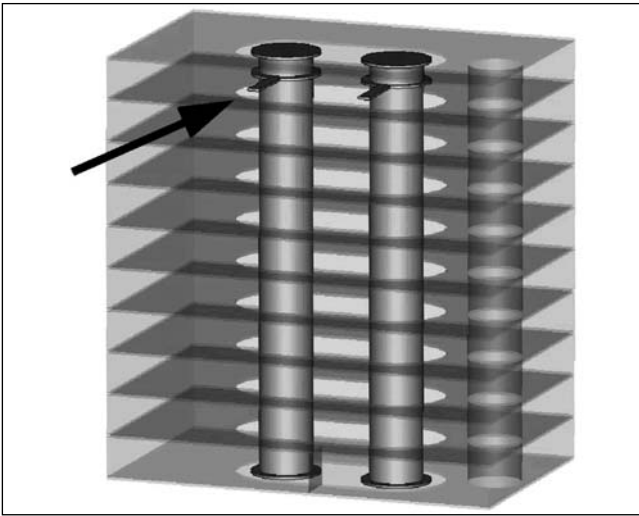

Top of pcb (conecor side)

Traces near the connector layer result in via stubs which cause undesirable reflections.

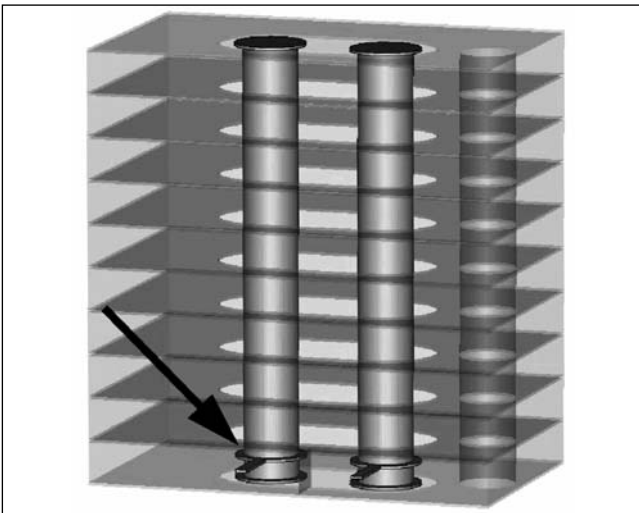

Top of pcb (conecor side)

Traces near the bottom layer improve the reflection behaviour.

ERmet ZD
High Speed Differential Hard Metric Connector System
Antipad Size

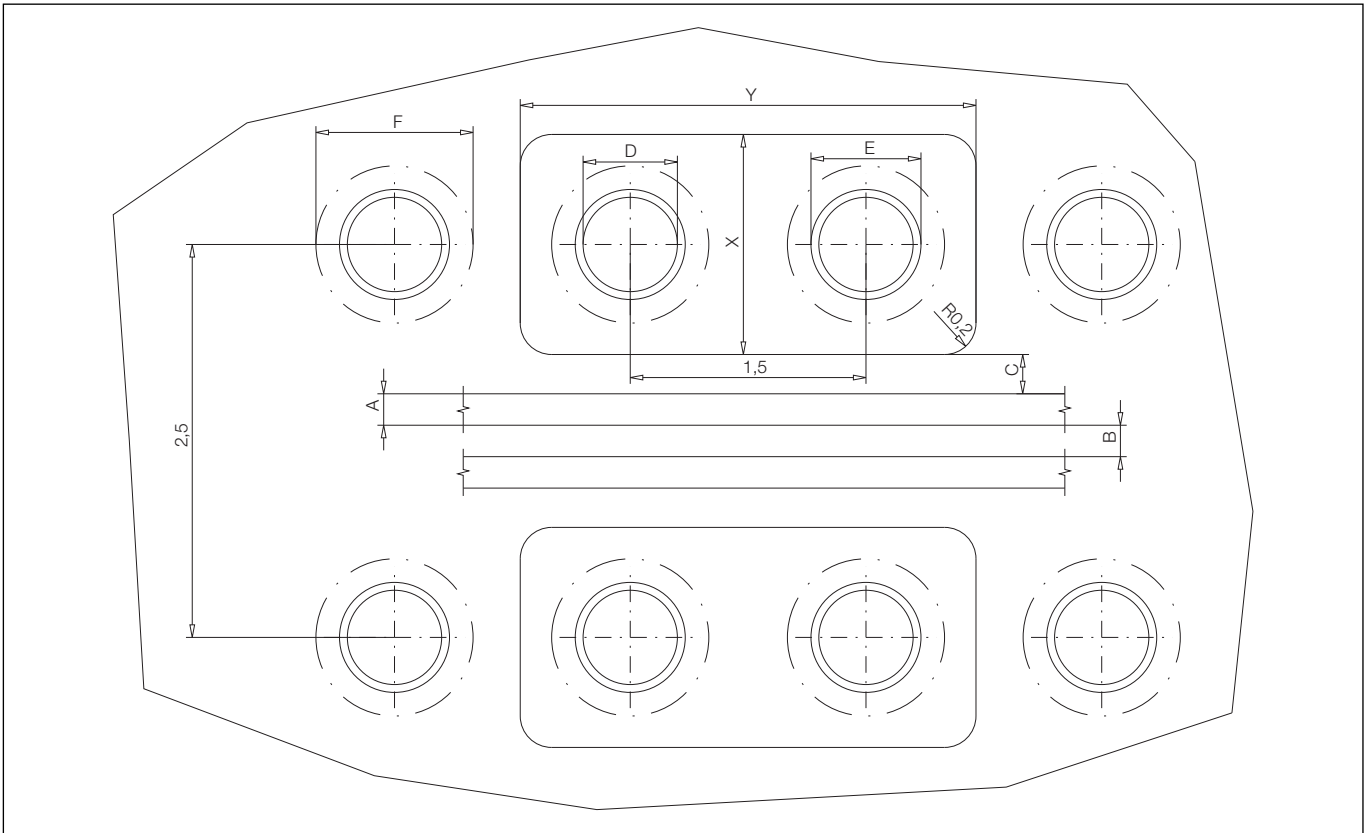

Drawing shows one differential track pair

A = trackwidth B = space between tracks C = space D = plated hole
 E = drill hole F = pad diameter X x Y = antipad size

The table below shows two examples for the antipad size

No. of Track-Pairs	Pad-Diameter	Antipad Size X x Y	Space C	Trackwidth A.	Space between Tracks B
2	1.0mm	1.3 x 2.8mm	0.075mm*	0.15mm	0.15mm
1	1.0mm	1.3 x 2.9mm	0.1mm*	0.25mm	0.4mm

(*) overlapping is necessary because of impedance control

Note:

To improve the high speed characteristics, remove all pads on unconnected layers!
 Smaller padsizes also improves the electrical characteristics!
 Antipad size as large as possible also improves the electrical characteristics!

ERmet ZD

High Speed Differential Hard Metric Connector System

Additional Mechanical Features



Termination Details

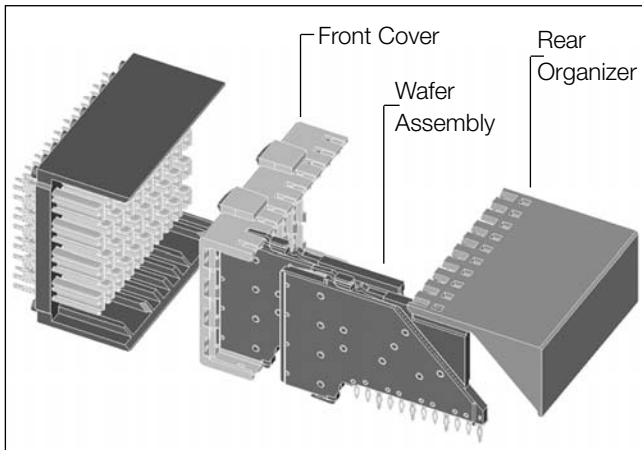

ERmetZD backplane and daughter card modules are available in pressfit versions. The parts are fully intermateable and differ physically only in their printed circuit board layout requirements.

The pressfit versions utilize the same eye of the needle compliant pin design for both the signal and ground terminals. The finished plated through-hole requirements are 0.55mm to 0.65mm which is the same hole specified by IEC 61076-4-101 for all 2mm HM connectors.

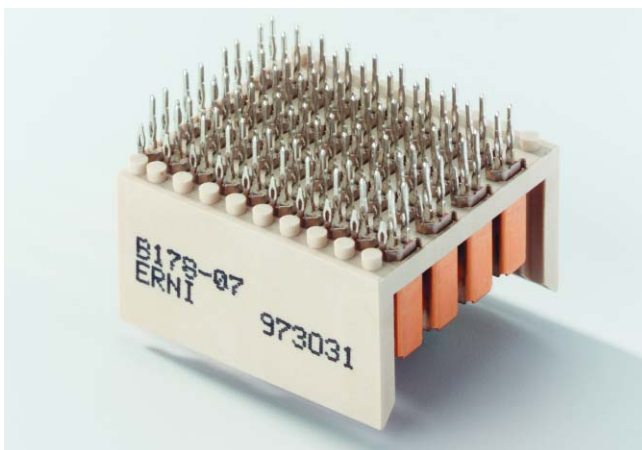

All ERmetZD modules are designed with an air gap between the connector and the board to facilitate convection reflow soldering methods. Additionally, the housing materials are comprised of a thermally stable polymer made to withstand higher temperatures.

Alignment Modules



Optional Alignment Module

The solid alignment modules secure correct mating of large size daughter cards. To prevent damage to a system resulting from incorrect insertion of cards with different logic, coding keys can be snapped into the optional alignment modules. These are the same color coded keys defined within the IEC 61076-4-101 standard. The IEC standard defines a unique configuration and color for more than 70 different coding keys.

ERmet ZD

High Speed Differential Hard Metric Connector System

Additional Mechanical Features



Basic Grid Design

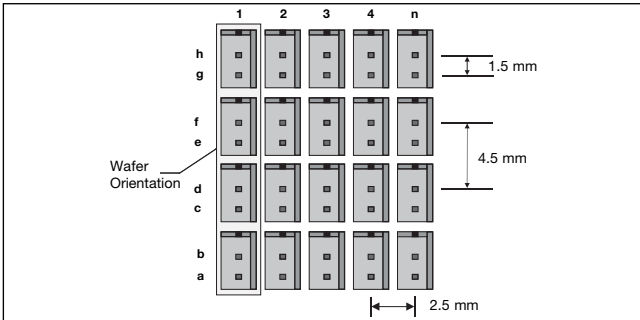

The design of today's high speed differential connectors is limited primarily by the electrical characteristics of the termination via geometry. The ERmetZD utilizes an optimum grid design which significantly reduces noise within the pattern and allows generous clearance for easier routing.

Trace Density

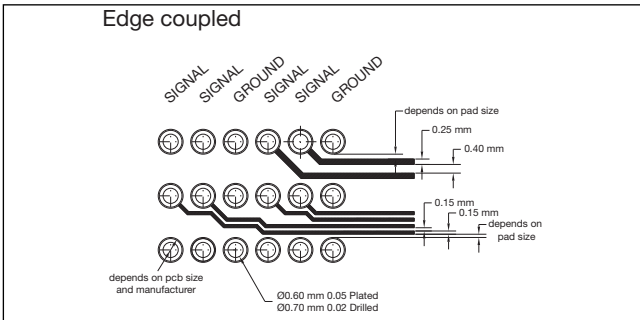

The grid pattern allows wide traces for long runs without ever having to separate two differential pairs to negotiate via holes, as shown in the proposed layouts.

Plated Through-Holes for Pressfit Terminals

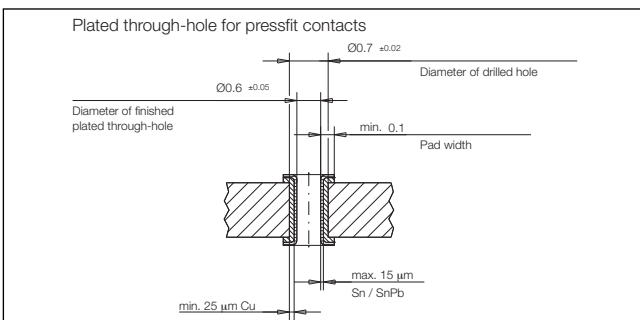

All ERmetZD, ERmet 5+2, ERmet 8+2 and ERmet Power Module pressfit terminals share plated through-hole requirements. These pressfit terminals have been used successfully with reflowed tin-lead, plated tin-lead, immersion tin, organic coatings over bare copper and immersion gold hole plating regimes. The hole recommendations and press in force information shown in this catalog are for reflowed tin-lead and plated tin-lead. Additional test data for other hole plating regimes are available through customer service.

Short Termination Pins of the Shield at the Male Pressfit Connectors.

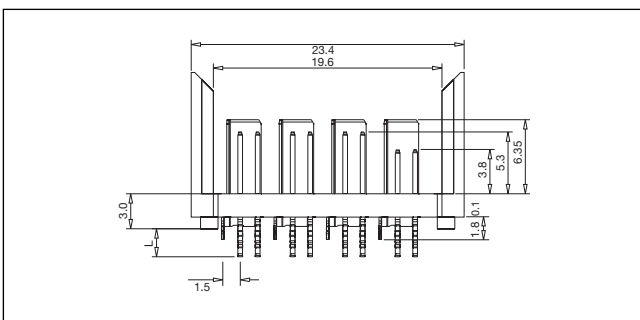

Note that the pressfit shield terminals are shorter than the pressfit terminals of the signal pins. This allows the standard shields to be used with signal terminals that are either 3.7mm or 1.8mm long.

ERmet ZD
High Speed Differential Hard Metric Connector System
Part Number Index



Part Number	Page
134883	28
134974	28
144470	32
163210	32
163211	32
174234	15
204685	30
204780	26
204781	24
220627	33
220628	33
220629	33
220630	33
220633	33
220634	33
220635	33
220635	33
220636	33
220637	33
220638	33
220639	33
220640	33
220758	33
220806	33
220879	33
220880	33
220895	33
223325	31
223396	17
244766	15
973019	18
973020	8
973023	13
973024	6
973027	17
973028	8
973031	12
973032	6
973046	10
973056	20
973061	12
973062	17
973063	20
973080	20
973096	12
973099	6
973101	22



Member



VMEbus INTERNATIONAL TRADE ASSOCIATION





ERNI Electronics GmbH

Seestrasse 9, Postfach
73099 Adelberg/Germany
Tel +49 7166 50-0
Fax +49 7166 50-282
info@erni.de

Europe South America Africa Japan

ERNI Electronics, Inc.

2201 Westwood Ave
Richmond, VA 23230/USA
Tel +1 804 228-4100
Fax +1 804 228-4099
info.usa@erni.com

North America Canada Mexico

ERNI Asia Holding Pte Ltd.

Blk 4008 Ang Mo Kio Avenue 10
#04-01/02 Techplace I
Singapore 569625
Tel +65 6 555 5885
Fax +65 6 555 5995
info@erni-asia.com

Asia

www.erni.com

ERNI Electronics GmbH 2007 • Printed in Germany.
A policy of continuous improvement is followed and the right to alter any published data without notice is reserved.