

EMTB84A3D-32.768K [Click part number to visit Part Number Details page](#)

REGULATORY COMPLIANCE (Data Sheet downloaded on May 20, 2017)

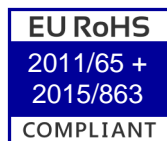

◀ Click badges to download compliance docs

Regulatory Compliance standards are subject to updates by governing bodies. Click the badges to download the latest compliance docs for this part number directly from Ecliptek.



ITEM DESCRIPTION

Temperature Compensated MEMS Clock Oscillators TCMO LVCMOS (CMOS) 2.8Vdc 4 Pad 0.8mm x 1.5mm Chip Scale Package (CSP) 32.768KHz 0°C to +70°C

ELECTRICAL SPECIFICATIONS

Nominal Frequency	32.768KHz
Frequency Stability	±5.0ppm Maximum (Inclusive of Operating Temperature Range, Output Load Change (±20%), and Reflow, at Vdd=2.8Vdc)
Frequency Stability vs. Frequency Tolerance	±5.0ppm Maximum (Measured at 25°C ±2°C, at Vdd=2.8Vdc, Post Reflow)
Frequency Stability vs. Input Voltage	±0.75ppm Maximum (±10%)
Frequency Stability vs. Aging	±1ppm/Year Maximum (at 25°C)
Operating Temperature Range	0°C to +70°C
Supply Voltage	2.8Vdc ±10%
Core Operating Current	0.99µA Typical (at 25°C), 1.52µA Maximum
Output Stage Operating Current	0.065µA/Vpp Typical, 0.125µA/Vpp Maximum
Input Current	1.2µA Typical (at 25°C), 1.9µA Maximum (No Load, Nominal Vdd)
Output Voltage Logic High (Voh)	90% of Vdd Minimum (IOH = -10µA)
Output Voltage Logic Low (Vol)	10% of Vdd Maximum (IOL = +10µA)
Rise/Fall Time	100nSec Typical, 200nSec Maximum (Measured at 10% to 90% of waveform)
Duty Cycle	50 ±2(%) (Measured at 50% of waveform)
Load Drive Capability	15pF Maximum
Output Logic Type	CMOS
Peak to Peak Jitter (tPK)	2.5µSec Maximum
Period Jitter (RMS)	33nSec Typical (Measured at 25°C)
Power Supply Ramp	100mSec Maximum (Measured at 0Vdc to 90% of Vdd)
Start Up Time	180mSec Typical, 350mSec Maximum (Measured at Nominal Vdd)
Storage Temperature Range	-55°C to +125°C

ENVIRONMENTAL & MECHANICAL SPECIFICATIONS

ESD Susceptibility	JESD22-A114, HBM, 3000V
Flammability	UL94-V0
Mechanical Shock	MIL-STD-883, Method 2002, Condition E, 10,000G
Moisture Sensitivity	J-STD-020, MSL 1
Solderability	MIL-STD-883, Method 2003
Temperature Cycling	JESD22-A104, Condition G
Vibration	MIL-STD-883, Method 2007, Condition C, 70G

EMTB84A3D-32.768K [Click part number to visit Part Number Details page](#)

MECHANICAL DIMENSIONS (all dimensions in millimeters)

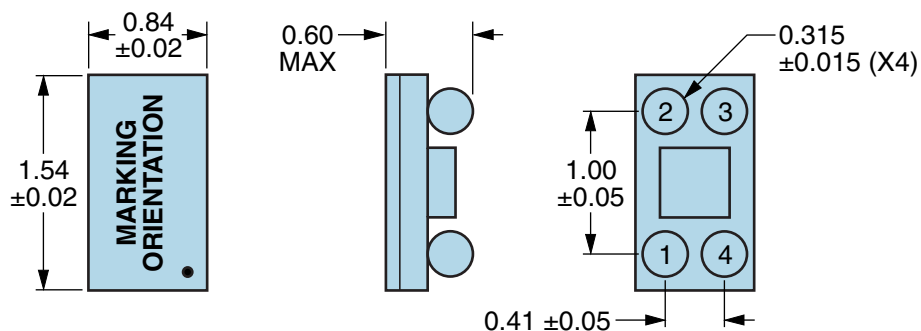

PIN	CONNECTION
1	Ground
2	Output
3	Supply Voltage
4	Ground

LINE	MARKING
1	XX XX=Ecliptek Manufacturing Identifier
2	XXX XXX=Ecliptek Manufacturing Identifier (continued)

Suggested Solder Pad Layout

All Dimensions in Millimeters

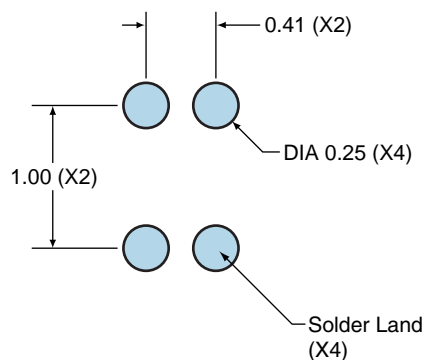

All Tolerances are ±0.1

EMTB84A3D-32.768K [Click part number to visit Part Number Details page](#)



OUTPUT WAVEFORM

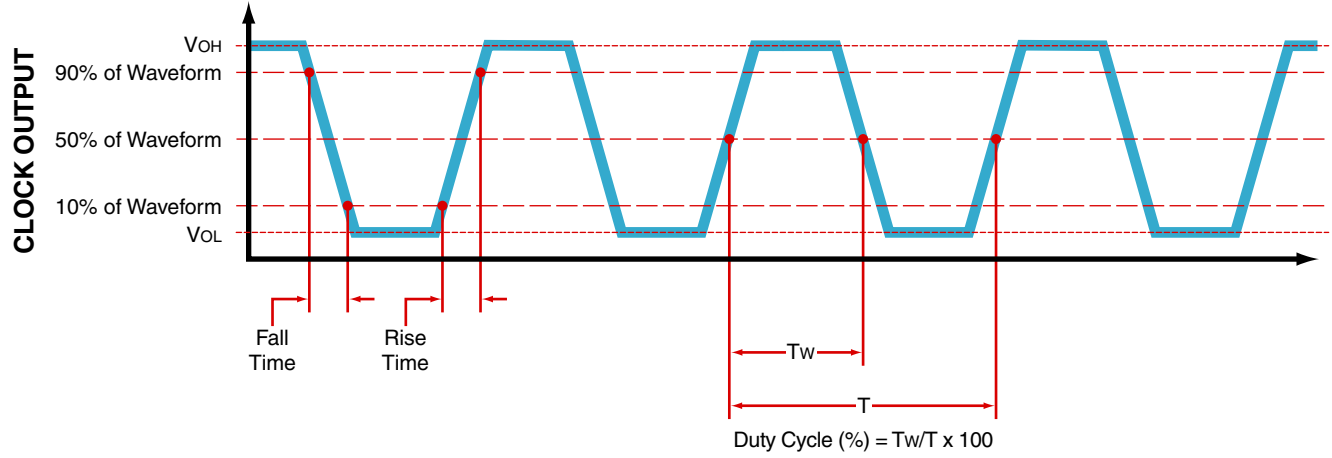

Test Circuit for CMOS Output

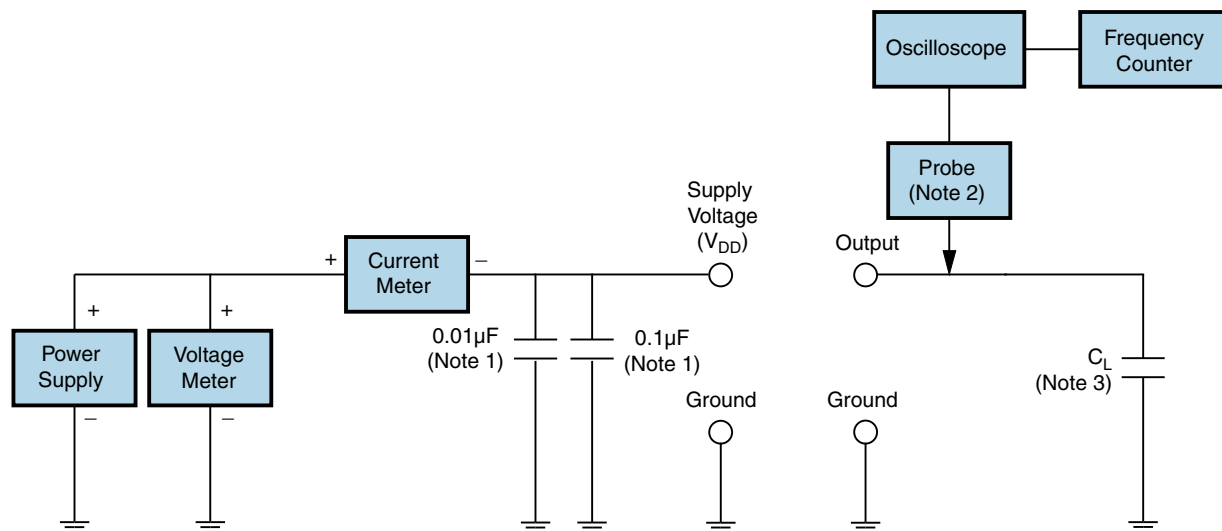

Note 1: An external 0.01 μ F ceramic bypass capacitor in parallel with a 0.1 μ F high frequency ceramic bypass capacitor close (less than 2mm) to the package ground and supply voltage pin is recommended.

Note 2: A low input capacitance (<12pF), 10X Attenuation Factor, High Impedance (>10Mohms), and High bandwidth (>300MHz) passive probe is recommended.

Note 3: Capacitance value C_L includes sum of all probe and fixture capacitance. See applicable specification sheet for 'Load Drive Capability'.

EMTB84A3D-32.768K

[Click part number to visit Part Number Details page](#)

Recommended Solder Reflow Methods

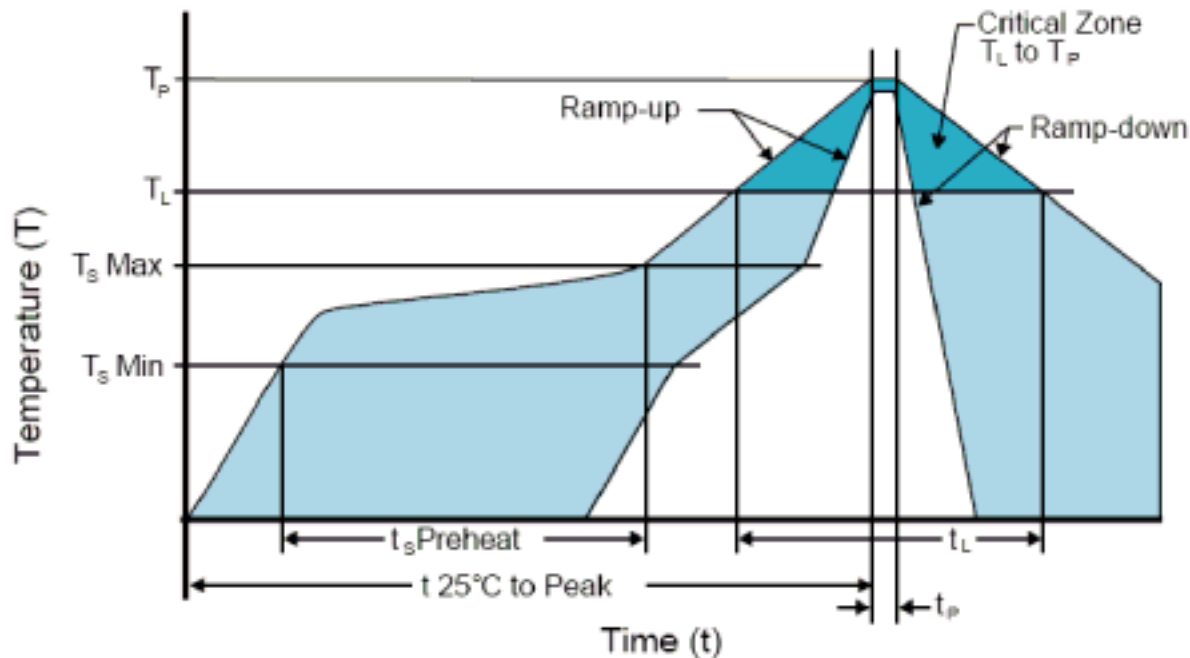

High Temperature Infrared/Convection

Ts MAX to TL (Ramp-up Rate)	3°C/Second Maximum
Preheat	
- Temperature Minimum (Ts MIN)	150°C
- Temperature Typical (Ts TYP)	175°C
- Temperature Maximum (Ts MAX)	200°C
- Time (ts MIN)	60 - 180 Seconds
Ramp-up Rate (TL to TP)	3°C/Second Maximum
Time Maintained Above:	
- Temperature (TL)	217°C
- Time (tL)	60 - 150 Seconds
Peak Temperature (TP)	260°C Maximum for 10 Seconds Maximum
Target Peak Temperature (TP Target)	250°C +0/-5°C
Time within 5°C of actual peak (tp)	20 - 40 Seconds
Ramp-down Rate	6°C/Second Maximum
Time 25°C to Peak Temperature (t)	8 Minutes Maximum
Moisture Sensitivity Level	Level 1
Additional Notes	Temperature shown are applied to body of device.

EMTB84A3D-32.768K [Click part number to visit Part Number Details page](#)

Recommended Solder Reflow Methods

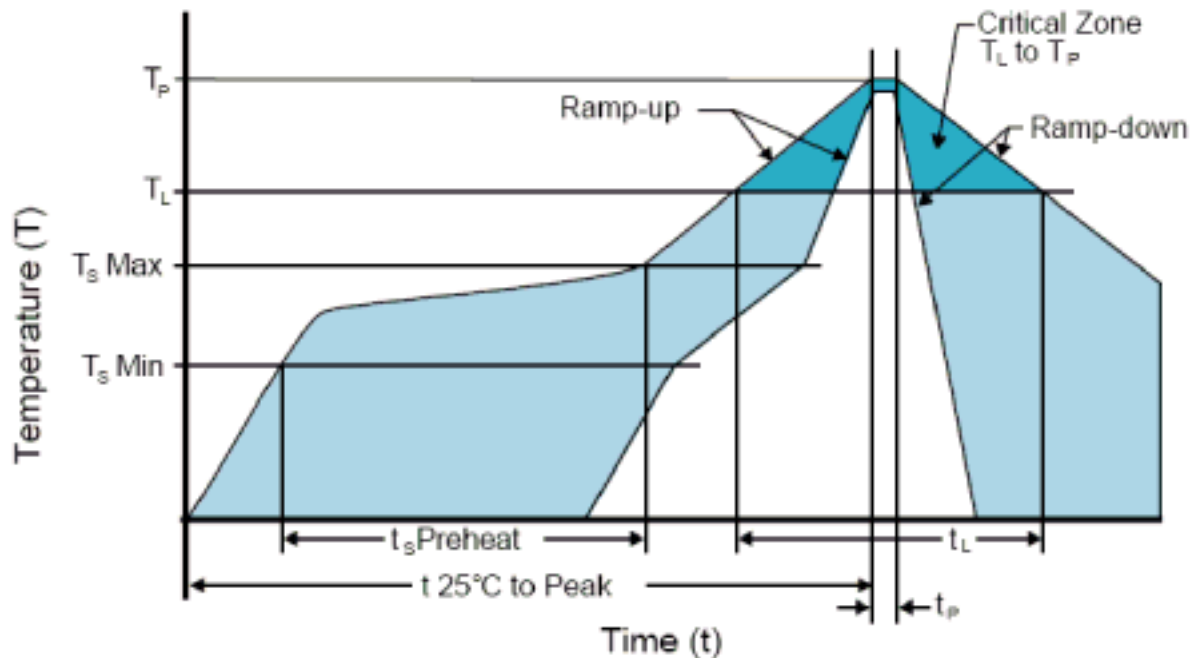

Low Temperature Infrared/Convection 240°C

Ts MAX to TL (Ramp-up Rate)	5°C/Second Maximum
Preheat	
- Temperature Minimum (Ts MIN)	N/A
- Temperature Typical (Ts TYP)	150°C
- Temperature Maximum (Ts MAX)	N/A
- Time (ts MIN)	60 - 120 Seconds
Ramp-up Rate (TL to TP)	5°C/Second Maximum
Time Maintained Above:	
- Temperature (TL)	150°C
- Time (tL)	200 Seconds Maximum
Peak Temperature (TP)	240°C Maximum
Target Peak Temperature (TP Target)	240°C Maximum 2 Times / 230°C Maximum 1 Time
Time within 5°C of actual peak (tp)	10 Seconds Maximum 2 Times / 80 Seconds Maximum 1 Time
Ramp-down Rate	5°C/Second Maximum
Time 25°C to Peak Temperature (t)	N/A
Moisture Sensitivity Level	Level 1
Additional Notes	Temperature shown are applied to body of device.

Low Temperature Manual Soldering

185°C Maximum for 10 Seconds Maximum, 2 times Maximum. (Temperature shown are applied to body of device.)

High Temperature Manual Soldering

260°C Maximum for 5 Seconds Maximum, 2 times Maximum. (Temperature shown are applied to body of device.)