

COMLINEAR® CLC1006

Single, 500MHz Voltage Feedback Amplifier

FEATURES

- 500MHz -3dB bandwidth at G=2
- 1,400V/ μ s slew rate
- 0.02%/0.05° diff. gain/phase error
- 300MHz large signal bandwidth
- 5.5mA supply current
- 5nV/ $\sqrt{\text{Hz}}$ input voltage noise
- 100mA output current
- Stable for gains ≥ 2
- Fully specified at 5V and $\pm 5\text{V}$ supplies
- CLC1006: Pb-free SOT23-5 and SOIC8

APPLICATIONS

- Video line drivers
- Imaging applications
- Professional cameras
- Differential line receivers
- Photodiode preamps
- Radar or communication receivers

General Description

The COMLINEAR CLC1006 is a high-performance, voltage feedback amplifier that offers bandwidth and slew rate usually found in current feedback amplifiers. The CLC1006 provides 500MHz bandwidth and 1,400V/ μ s slew rate exceeding the requirements of standard-definition television and other multimedia applications. The COMLINEAR CLC1006 high-performance amplifier also provides ample output current to drive multiple video loads.

The COMLINEAR CLC1006 is designed to operate from $\pm 5\text{V}$ or $+5\text{V}$ supplies. It consumes only 5.5mA of supply current. The combination of high-speed, excellent video performance, and 10ns settling time make the CLC1006 well suited for use in many general purpose, high-speed applications including standard definition video and imaging applications.

Typical Application - Driving Dual Video Loads

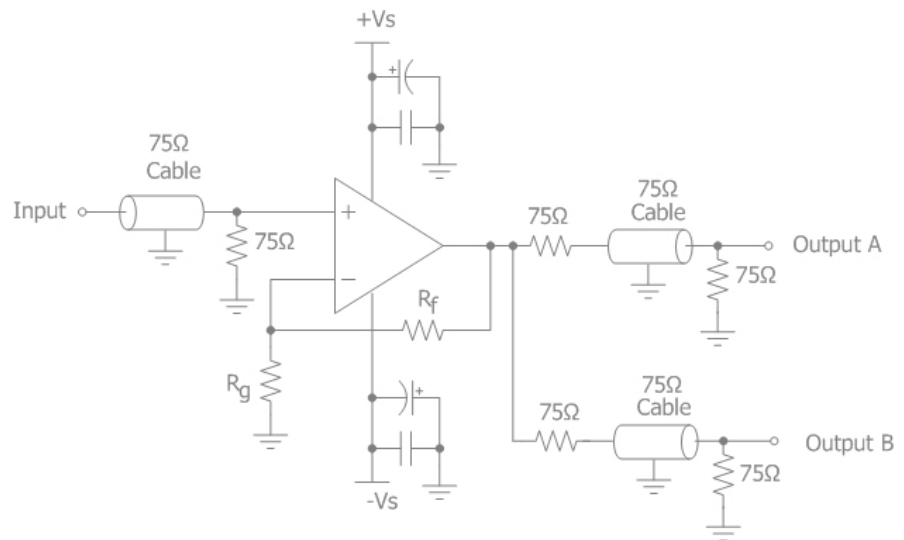

Ordering Information

Part Number	Package	Pb-Free	RoHS Compliant	Operating Temperature Range	Packaging Method
CLC1006IST5X	SOT23-5	Yes	Yes	-40°C to +85°C	Reel
CLC1006ISO8X	SOIC-8	Yes	Yes	-40°C to +85°C	Reel

Moisture sensitivity level for all parts is MSL-1.



SOT23-5 Pin Configuration

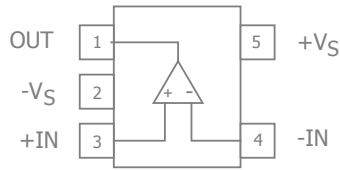

SOT23-5 Pin Assignments

Pin No.	Pin Name	Description
1	OUT	Output
2	-VS	Negative supply
3	+IN	Positive input
4	-IN	Negative input
5	+VS	Positive supply

SOIC Pin Configuration

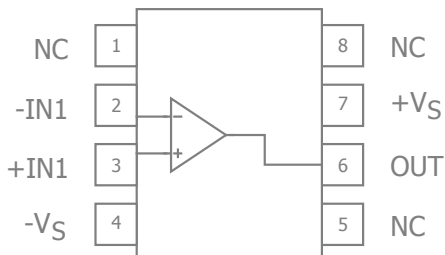

SOIC Pin Assignments

Pin No.	Pin Name	Description
1	NC	No connect
2	-IN1	Negative input, channel 1
3	+IN1	Positive input, channel 1
4	-VS	Negative supply
5	NC	No connect
6	OUT	Output
7	+VS	Positive supply
8	NC	No connect



Absolute Maximum Ratings

The safety of the device is not guaranteed when it is operated above the "Absolute Maximum Ratings". The device should not be operated at these "absolute" limits. Adhere to the "Recommended Operating Conditions" for proper device function. The information contained in the Electrical Characteristics tables and Typical Performance plots reflect the operating conditions noted on the tables and plots.

Parameter	Min	Max	Unit
Supply Voltage	0	14	V
Input Voltage Range	$-V_S - 0.5V$	$+V_S + 0.5V$	V
Continuous Output Current		100	mA

Reliability Information

Parameter	Min	Typ	Max	Unit
Junction Temperature			150	°C
Storage Temperature Range	-65		150	°C
Lead Temperature (Soldering, 10s)			260	°C
Package Thermal Resistance				
5-Lead SOT23		221		°C/W
8-Lead SOIC		100		°C/W

Notes:

Package thermal resistance (θ_{JA}), JEDEC standard, multi-layer test boards, still air.

ESD Protection

Product	SOT23-5
Human Body Model (HBM)	2kV
Charged Device Model (CDM)	1kV

Recommended Operating Conditions

Parameter	Min	Typ	Max	Unit
Operating Temperature Range	-40		+85	°C
Supply Voltage Range	4.5		12	V

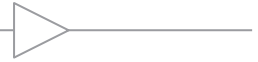

Electrical Characteristics at +5V

$T_A = 25^\circ\text{C}$, $V_S = +5\text{V}$, $R_f = 150\Omega$, $R_L = 150\Omega$ to $V_S/2$, $G = 2$; unless otherwise noted.

Symbol	Parameter	Conditions	Min	Typ	Max	Units
Frequency Domain Response						
BW_{SS}	-3dB Bandwidth	$G = +2$, $V_{OUT} = 0.2V_{pp}$		400		MHz
BW_{LS}	Large Signal Bandwidth	$G = +2$, $V_{OUT} = 1V_{pp}$		335		MHz
$BW_{0.1dBSS}$	0.1dB Gain Flatness	$G = +2$, $V_{OUT} = 0.2V_{pp}$		50		MHz
$BW_{0.1dBLS}$	0.1dB Gain Flatness	$G = +2$, $V_{OUT} = 1V_{pp}$		125		MHz
Time Domain Response						
t_R, t_F	Rise and Fall Time	$V_{OUT} = 1\text{V}$ step; (10% to 90%)		1.4		ns
t_S	Settling Time to 0.1%	$V_{OUT} = 1\text{V}$ step		10		ns
OS	Overshoot	$V_{OUT} = 0.2\text{V}$ step		1		%
SR	Slew Rate	1V step		650		V/ μs
Distortion/Noise Response						
HD2	2nd Harmonic Distortion	$1V_{pp}$, 5MHz		-60		dBc
HD3	3rd Harmonic Distortion	$1V_{pp}$, 5MHz		-67		dBc
THD	Total Harmonic Distortion	$1V_{pp}$, 5MHz		-59		dB
IP3	Third-Order Intercept	$1V_{pp}$, 10MHz		32		dBm
SFDR	Spurious-Free Dynamic Range	$1V_{pp}$, 5MHz		60		dBc
D_G	Differential Gain	NTSC (3.58MHz), AC-coupled, $R_L = 150\Omega$		0.01		%
D_P	Differential Phase	NTSC (3.58MHz), AC-coupled, $R_L = 150\Omega$		0.01		°
e_n	Input Voltage Noise	> 1MHz		5		nV/ $\sqrt{\text{Hz}}$
i_n	Input Current Noise	> 1MHz		3		pA/ $\sqrt{\text{Hz}}$
DC Performance						
V_{IO}	Input Offset Voltage			0		mV
dV_{IO}	Average Drift			1.2		$\mu\text{V}/^\circ\text{C}$
I_{bn}	Input Bias Current			± 3.2		μA
dI_b	Average Drift			7.5		nA/ $^\circ\text{C}$
PSRR	Power Supply Rejection Ratio	DC		60		dB
A_{OL}	Open-Loop Gain			55		dB
I_S	Supply Current			5.2		mA
Input Characteristics						
R_{IN}	Input Resistance	Non-inverting		4.5		M Ω
C_{IN}	Input Capacitance			1.0		pF
CMIR	Common Mode Input Range			1 to 4		V
CMRR	Common Mode Rejection Ratio	DC		50		dB
Output Characteristics						
R_O	Output Resistance	Closed Loop, DC		0.1		Ω
V_{OUT}	Output Voltage Swing	$R_L = 150\Omega$		1 to 4		V
I_{OUT}	Output Current			± 100		mA



Electrical Characteristics at $\pm 5V$

$T_A = 25^\circ C$, $V_S = \pm 5V$, $R_f = 150\Omega$, $R_L = 150\Omega$ to GND, $G = 2$; unless otherwise noted.

Symbol	Parameter	Conditions	Min	Typ	Max	Units
Frequency Domain Response						
BW_{SS}	-3dB Bandwidth	$G = +2$, $V_{OUT} = 0.2V_{pp}$		500		MHz
BW_{LS}	Large Signal Bandwidth	$G = +2$, $V_{OUT} = 2V_{pp}$		300		MHz
$BW_{0.1dBSS}$	0.1dB Gain Flatness	$G = +2$, $V_{OUT} = 0.2V_{pp}$		50		MHz
$BW_{0.1dBLS}$	0.1dB Gain Flatness	$G = +2$, $V_{OUT} = 2V_{pp}$		100		MHz
Time Domain Response						
t_R, t_F	Rise and Fall Time	$V_{OUT} = 2V$ step; (10% to 90%)		2.4		ns
t_S	Settling Time to 0.1%	$V_{OUT} = 2V$ step		10		ns
OS	Overshoot	$V_{OUT} = 0.2V$ step		1		%
SR	Slew Rate	2V step		1400		V/ μ s
Distortion/Noise Response						
HD2	2nd Harmonic Distortion	$2V_{pp}$, 5MHz		-68		dBc
HD3	3rd Harmonic Distortion	$2V_{pp}$, 5MHz		-63		dBc
THD	Total Harmonic Distortion	$2V_{pp}$, 5MHz		-62		dB
IP3	Third-Order Intercept	$2V_{pp}$, 10MHz		32		dBm
SFDR	Spurious-Free Dynamic Range	$2V_{pp}$, 5MHz		63		dBc
D_G	Differential Gain	NTSC (3.58MHz), AC-coupled, $R_L = 150\Omega$		0.02		%
D_P	Differential Phase	NTSC (3.58MHz), AC-coupled, $R_L = 150\Omega$		0.05		$^\circ$
e_n	Input Voltage Noise	> 1MHz		5		nV/ \sqrt{Hz}
i_{ni}	Input Current Noise	> 1MHz		3		pA/ \sqrt{Hz}
DC Performance						
V_{IO}	Input Offset Voltage ⁽¹⁾		-10	0	10	mV
dV_{IO}	Average Drift			1.2		μ V/ $^\circ$ C
I_b	Input Bias Current ⁽¹⁾		-20	± 3.2	20	μ A
dI_b	Average Drift			7.5		nA/ $^\circ$ C
PSRR	Power Supply Rejection Ratio ⁽¹⁾	DC	40	75		dB
A_{OL}	Open-Loop Gain			61		dB
I_S	Supply Current ⁽¹⁾			5.5	10	mA
Input Characteristics						
R_{IN}	Input Resistance	Non-inverting		4.5		M Ω
C_{IN}	Input Capacitance			1.0		pF
CMIR	Common Mode Input Range			± 3.8		V
CMRR	Common Mode Rejection Ratio ⁽¹⁾	DC	40	65		dB
Output Characteristics						
R_O	Output Resistance	Closed Loop, DC		0.1		Ω
V_{OUT}	Output Voltage Swing	$R_L = 150\Omega$ ⁽¹⁾	± 3.0	± 3.6		V
I_{OUT}	Output Current			± 200		mA

Notes:

- 100% tested at $25^\circ C$



Typical Performance Characteristics

$T_A = 25^\circ\text{C}$, $V_S = \pm 5\text{V}$, $R_f = 150\Omega$, $R_L = 150\Omega$ to GND, $G = 2$; unless otherwise noted.

Non-Inverting Frequency Response

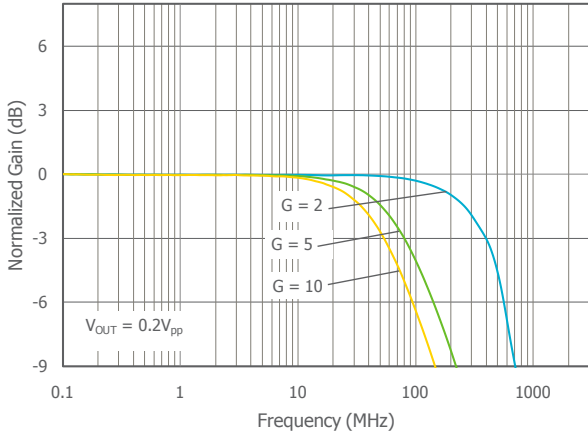

Inverting Frequency Response

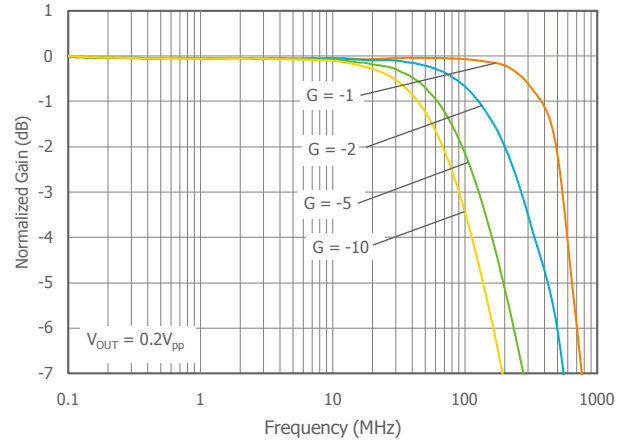

Frequency Response vs. C_L

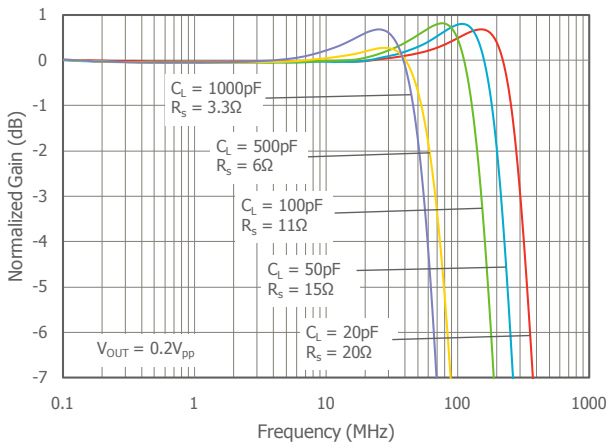

Frequency Response vs. R_L

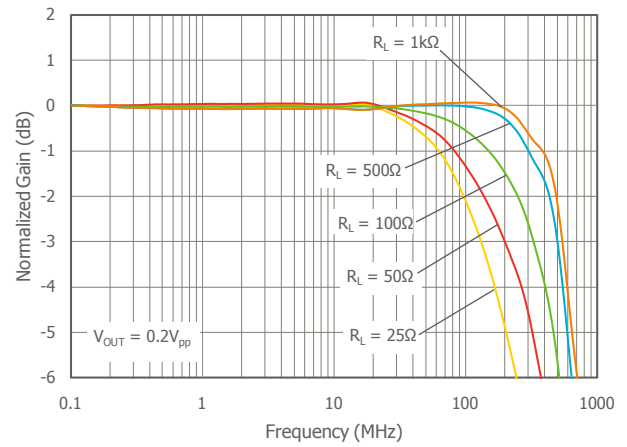

Frequency Response vs. V_{OUT}

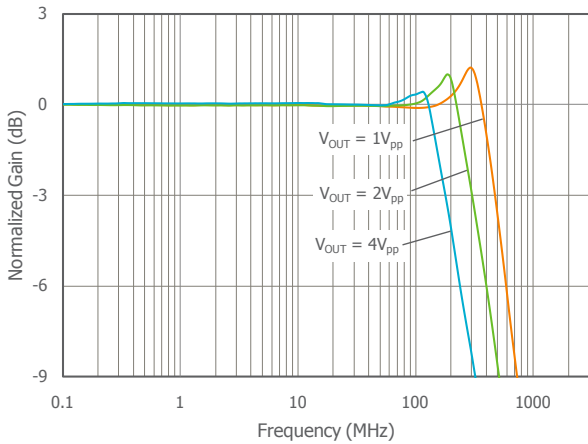

Frequency Response vs. Temperature

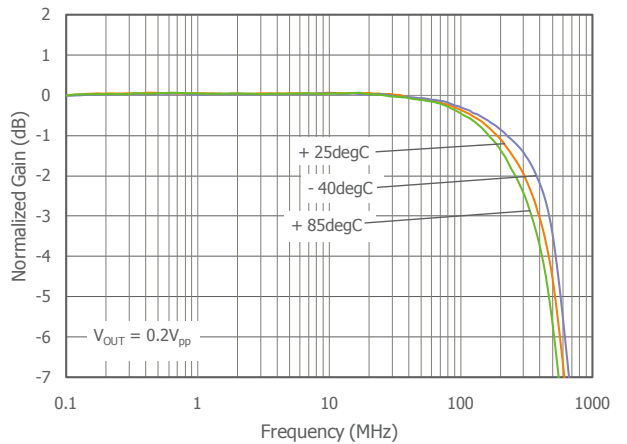



Typical Performance Characteristics

$T_A = 25^\circ\text{C}$, $V_S = \pm 5\text{V}$, $R_f = 150\Omega$, $R_L = 150\Omega$ to GND, $G = 2$; unless otherwise noted.

Non-Inverting Frequency Response at $V_S = 5\text{V}$

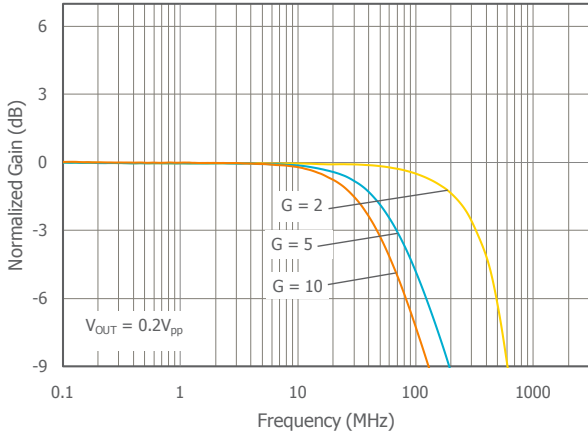

Inverting Frequency Response at $V_S = 5\text{V}$

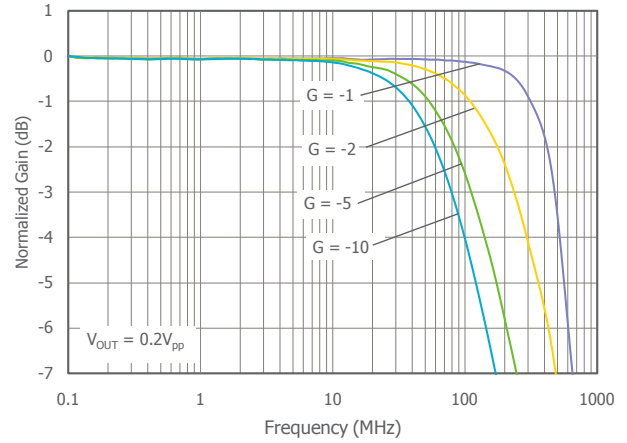

Frequency Response vs. C_L at $V_S = 5\text{V}$

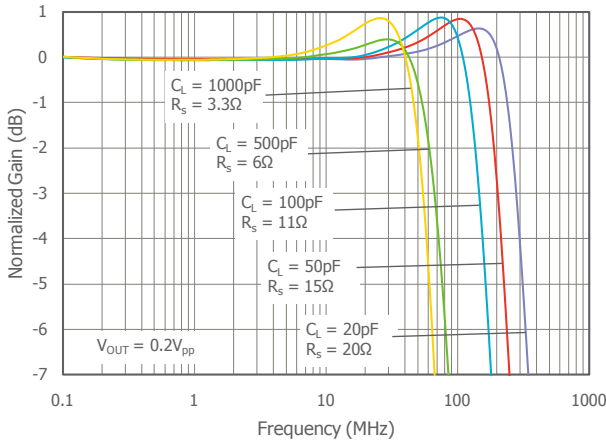

Frequency Response vs. R_L at $V_S = 5\text{V}$

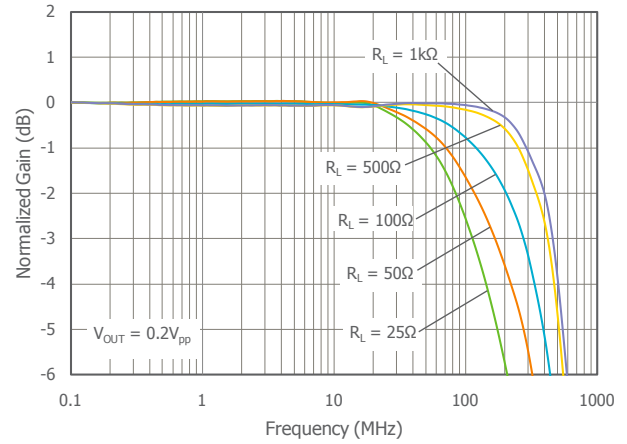

Frequency Response vs. V_{OUT} at $V_S = 5\text{V}$

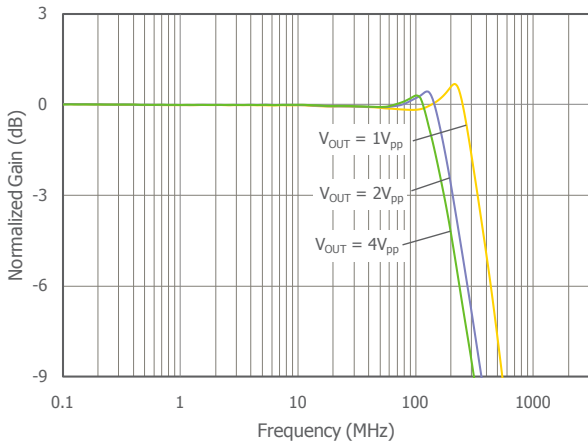

Frequency Response vs. Temperature at $V_S = 5\text{V}$

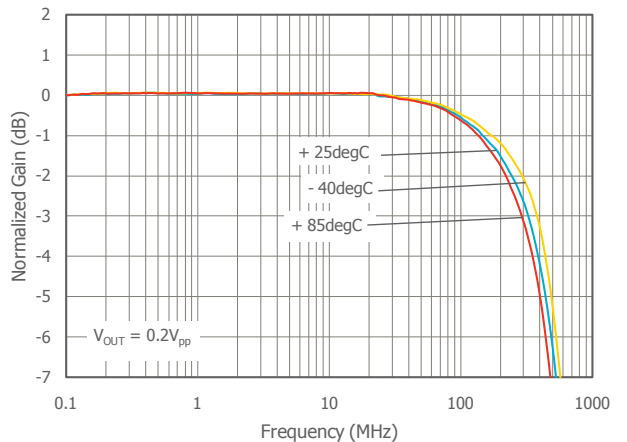



Typical Performance Characteristics - Continued

$T_A = 25^\circ\text{C}$, $V_S = \pm 5\text{V}$, $R_f = 150\Omega$, $R_L = 150\Omega$ to GND, $G = 2$; unless otherwise noted.

Gain Flatness

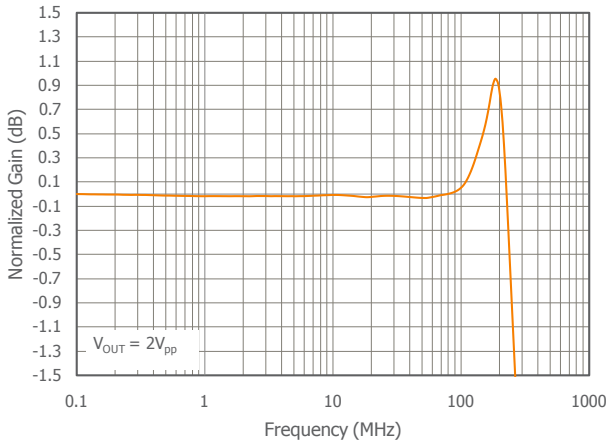

Gain Flatness at $V_S = 5\text{V}$

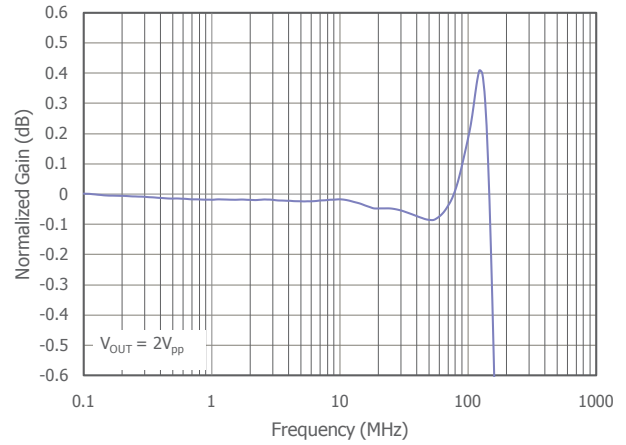

-3dB Bandwidth vs. V_{OUT}

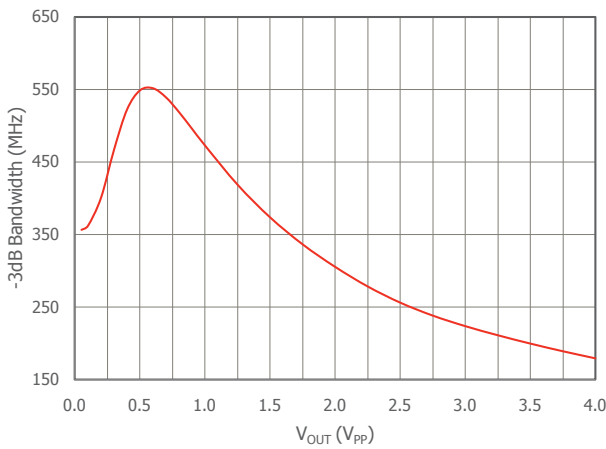

-3dB Bandwidth vs. V_{OUT} at $V_S = 5\text{V}$

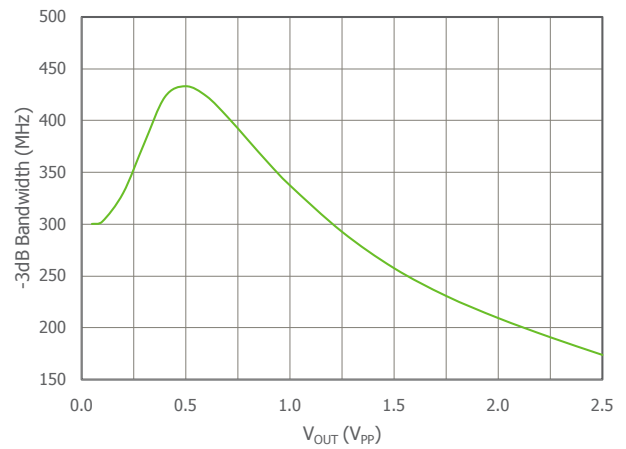

Closed Loop Output Impedance vs. Frequency

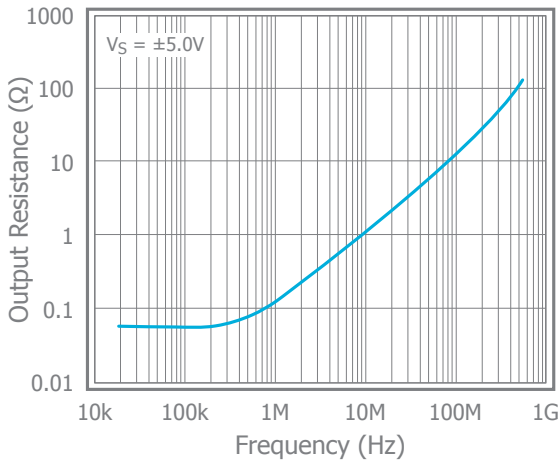

Input Voltage Noise

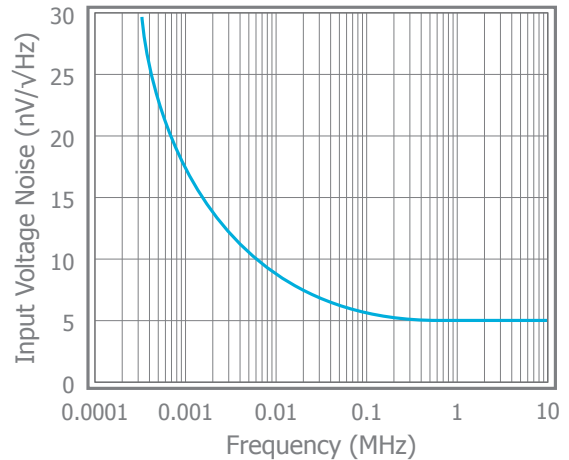

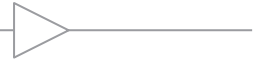

Typical Performance Characteristics - Continued

$T_A = 25^\circ\text{C}$, $V_S = \pm 5\text{V}$, $R_f = 150\Omega$, $R_L = 150\Omega$ to GND, $G = 2$; unless otherwise noted.

2nd Harmonic Distortion vs. R_L

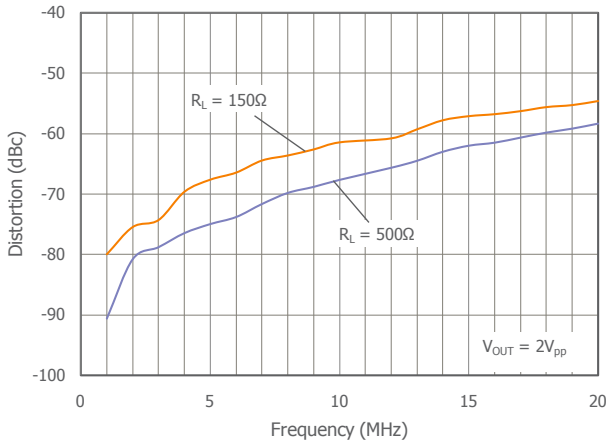

3rd Harmonic Distortion vs. R_L

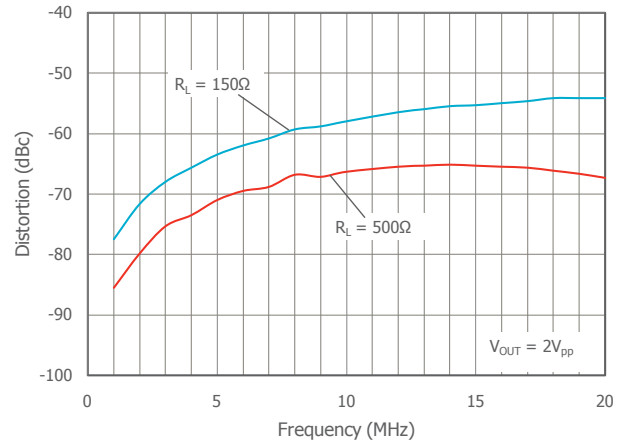

2nd Harmonic Distortion vs. V_{OUT}

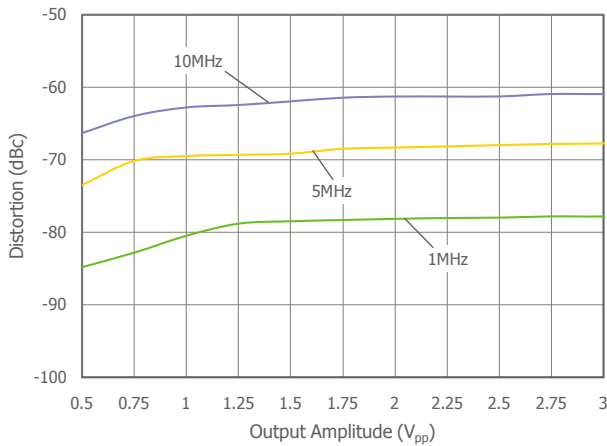

3rd Harmonic Distortion vs. V_{OUT}

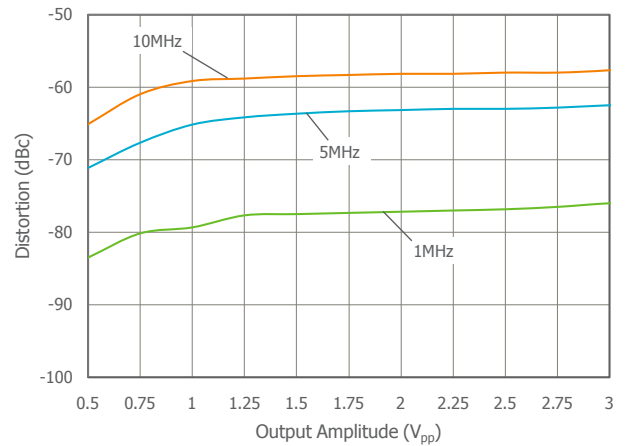

CMRR vs. Frequency

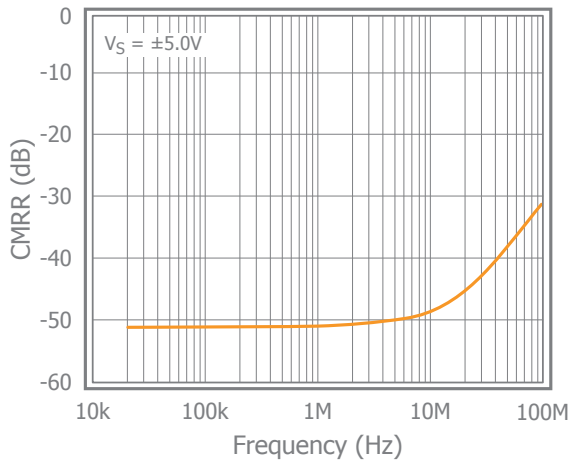

PSRR vs. Frequency

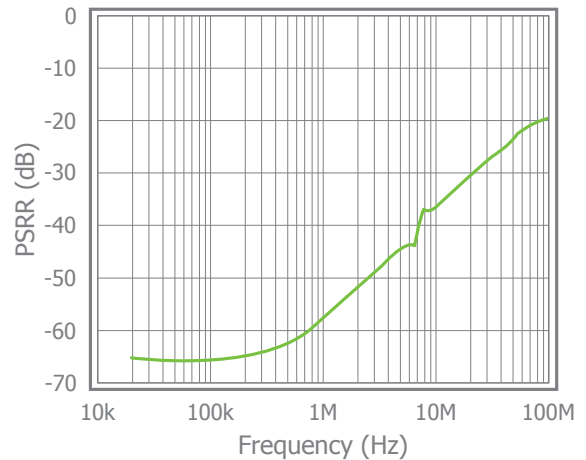

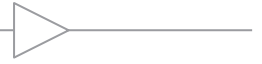

Typical Performance Characteristics - Continued

$T_A = 25^\circ\text{C}$, $V_S = \pm 5\text{V}$, $R_f = 150\Omega$, $R_L = 150\Omega$ to GND, $G = 2$; unless otherwise noted.

Small Signal Pulse Response

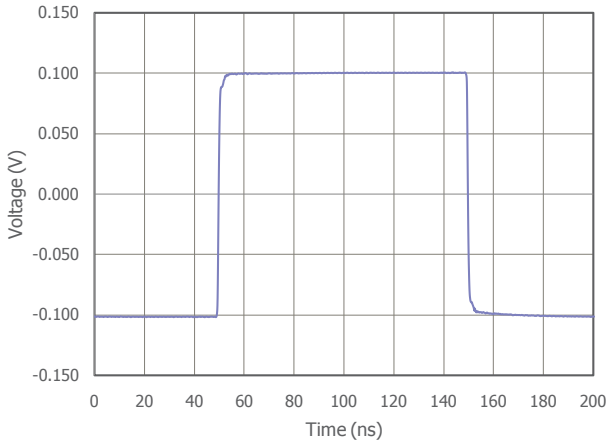

Small Signal Pulse Response at $V_S = 5\text{V}$

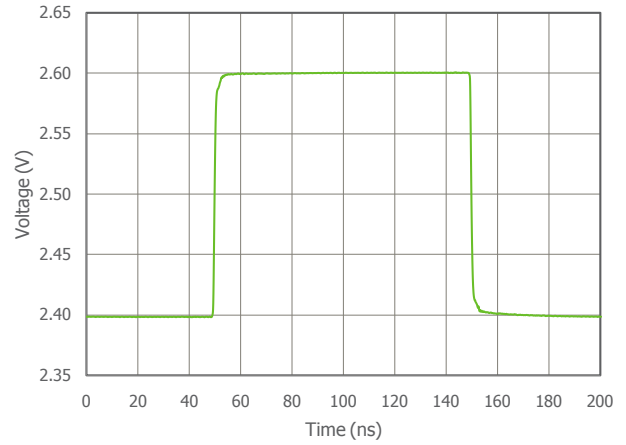

Large Signal Pulse Response

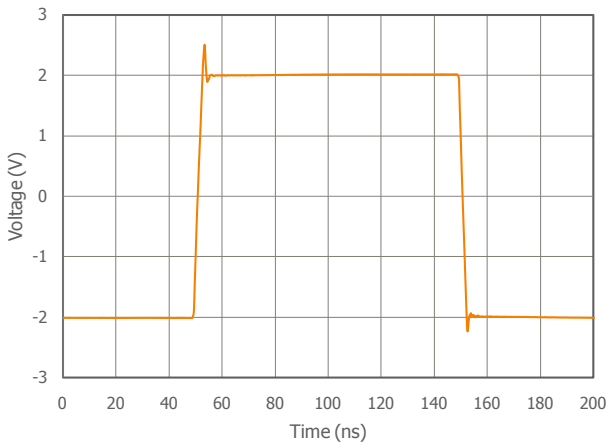

Large Signal Pulse Response at $V_S = 5\text{V}$

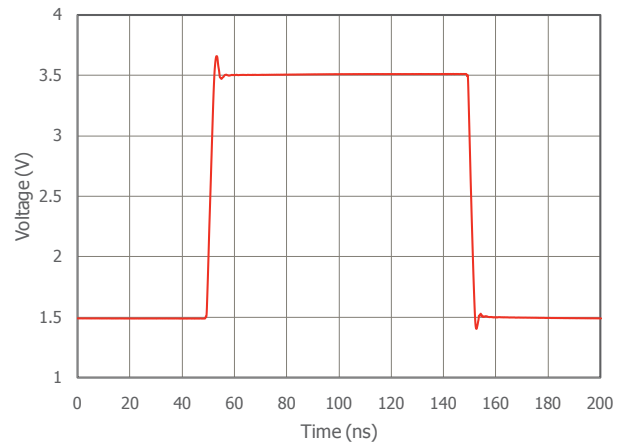

Differential Gain & Phase AC Coupled Output

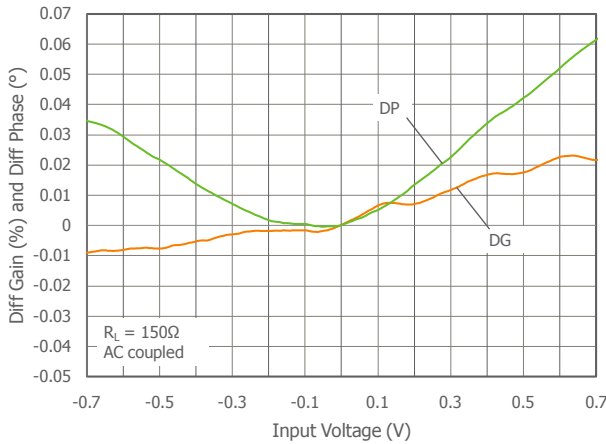

Differential Gain & Phase DC Coupled Output

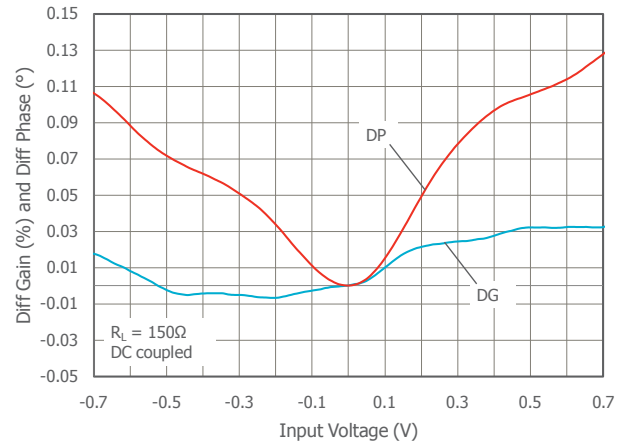

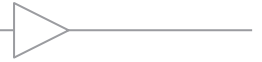

Typical Performance Characteristics - Continued

$T_A = 25^\circ\text{C}$, $V_S = \pm 5\text{V}$, $R_f = 150\Omega$, $R_L = 150\Omega$ to GND, $G = 2$; unless otherwise noted.

Differential Gain & Phase AC Coupled Output at $V_S = \pm 2.5\text{V}$

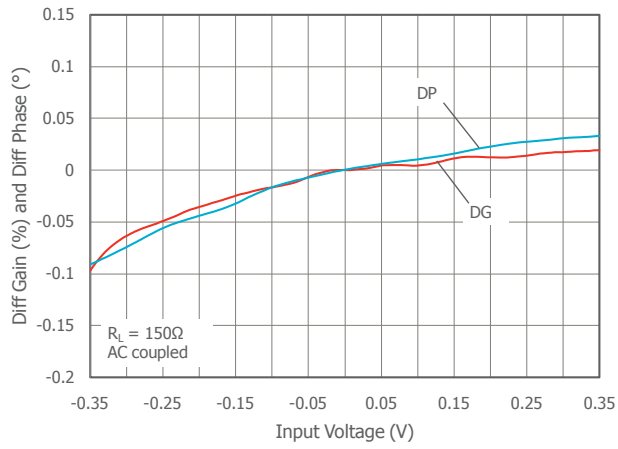

Differential Gain & Phase DC Coupled at $V_S = \pm 2.5\text{V}$

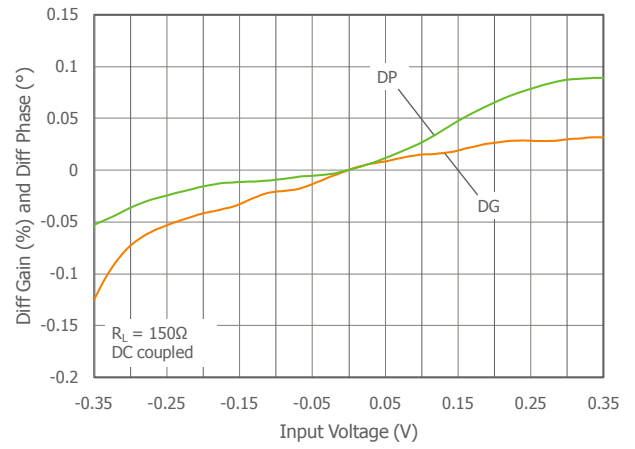



Application Information

Basic Operation

Figures 1 and 2 illustrate typical circuit configurations for non-inverting, inverting, and unity gain topologies for dual supply applications. They show the recommended bypass capacitor values and overall closed loop gain equations.

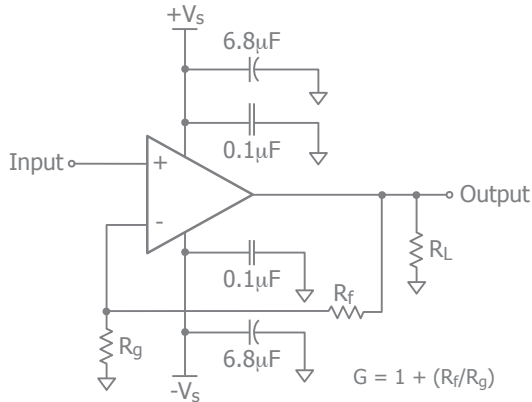

Figure 1. Typical Non-Inverting Gain Circuit

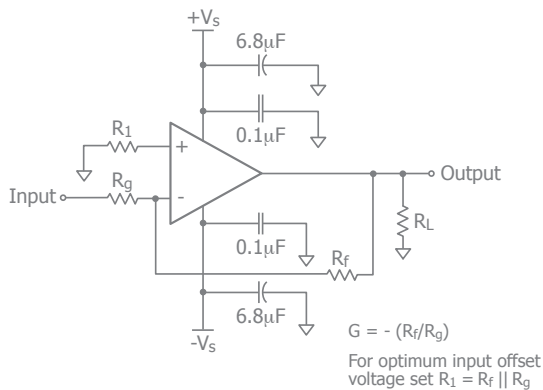

Figure 2. Typical Inverting Gain Circuit

Power Dissipation

Power dissipation should not be a factor when operating under the stated 1000 ohm load condition. However, applications with low impedance, DC coupled loads should be analyzed to ensure that maximum allowed junction temperature is not exceeded. Guidelines listed below can be used to verify that the particular application will not cause the device to operate beyond its intended operating range.

Maximum power levels are set by the absolute maximum junction rating of 150°C. To calculate the junction tem-

perature, the package thermal resistance value Θ_{JA} (Θ_{JA}) is used along with the total die power dissipation.

$$T_{\text{Junction}} = T_{\text{Ambient}} + (\Theta_{JA} \times P_D)$$

Where T_{Ambient} is the temperature of the working environment.

In order to determine P_D , the power dissipated in the load needs to be subtracted from the total power delivered by the supplies.

$$P_D = P_{\text{supply}} - P_{\text{load}}$$

Supply power is calculated by the standard power equation.

$$P_{\text{supply}} = V_{\text{supply}} \times I_{\text{RMS supply}}$$

$$V_{\text{supply}} = V_{S+} - V_{S-}$$

Power delivered to a purely resistive load is:

$$P_{\text{load}} = ((V_{\text{LOAD}})_{\text{RMS}}^2) / R_{\text{load eff}}$$

The effective load resistor ($R_{\text{load eff}}$) will need to include the effect of the feedback network. For instance,

$R_{\text{load eff}}$ in figure 3 would be calculated as:

$$R_L \parallel (R_f + R_g)$$

These measurements are basic and are relatively easy to perform with standard lab equipment. For design purposes however, prior knowledge of actual signal levels and load impedance is needed to determine the dissipated power. Here, P_D can be found from

$$P_D = P_{\text{Quiescent}} + P_{\text{Dynamic}} - P_{\text{Load}}$$

Quiescent power can be derived from the specified I_S values along with known supply voltage, V_{Supply} . Load power can be calculated as above with the desired signal amplitudes using:

$$(V_{\text{LOAD}})_{\text{RMS}} = V_{\text{PEAK}} / \sqrt{2}$$

$$(I_{\text{LOAD}})_{\text{RMS}} = (V_{\text{LOAD}})_{\text{RMS}} / R_{\text{load eff}}$$

The dynamic power is focused primarily within the output stage driving the load. This value can be calculated as:

$$P_{\text{DYNAMIC}} = (V_{S+} - V_{\text{LOAD}})_{\text{RMS}} \times (I_{\text{LOAD}})_{\text{RMS}}$$

Assuming the load is referenced in the middle of the power rails or $V_{\text{supply}}/2$.

Figure 3 shows the maximum safe power dissipation in the package vs. the ambient temperature for the packages available.

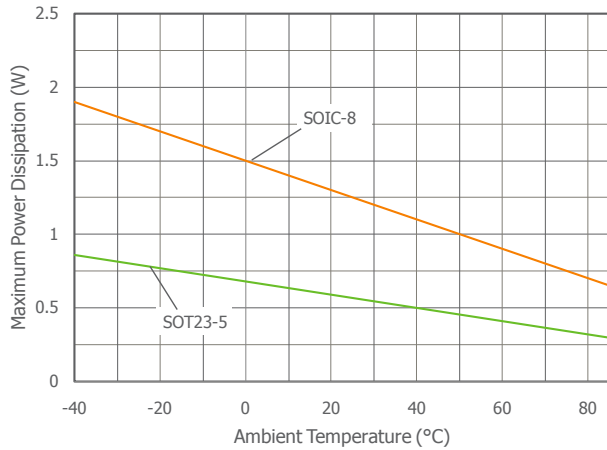

Figure 3. Maximum Power Derating

Driving Capacitive Loads

Increased phase delay at the output due to capacitive loading can cause ringing, peaking in the frequency response, and possible unstable behavior. Use a series resistance, R_S , between the amplifier and the load to help improve stability and settling performance. Refer to Figure 4.

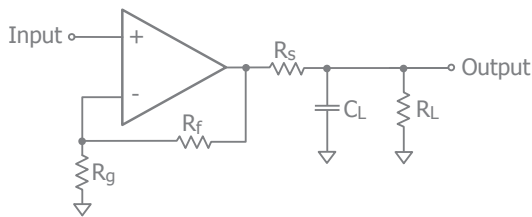

Figure 4. Addition of R_S for Driving Capacitive Loads

Table 1 provides the recommended R_S for various capacitive loads. The recommended R_S values result in ≤ 1 dB peaking in the frequency response. The Frequency Response vs. C_L plots, on page 7, illustrates the response of the CLC1006.

C_L (pF)	R_S (Ω)	-3dB BW (MHz)
20	20	300
50	15	210
100	11	150
500	6	68
1000	3.3	55

Table 1: Recommended R_S vs. C_L

For a given load capacitance, adjust R_S to optimize the tradeoff between settling time and bandwidth. In general,

reducing R_S will increase bandwidth at the expense of additional overshoot and ringing.

Overdrive Recovery

An overdrive condition is defined as the point when either one of the inputs or the output exceed their specified voltage range. Overdrive recovery is the time needed for the amplifier to return to its normal or linear operating point. The recovery time varies, based on whether the input or output is overdriven and by how much the range is exceeded. The CLC1006 will typically recover in less than 25ns from an overdrive condition. Figure 5 shows the CLC1006 in an overdriven condition.

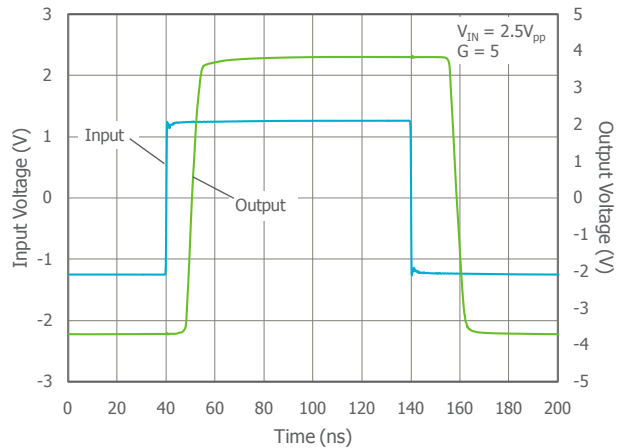

Figure 5. Overdrive Recovery

Layout Considerations

General layout and supply bypassing play major roles in high frequency performance. Exar has evaluation boards to use as a guide for high frequency layout and as aid in device testing and characterization. Follow the steps below as a basis for high frequency layout:

- Include 6.8 μ F and 0.1 μ F ceramic capacitors for power supply decoupling
- Place the 6.8 μ F capacitor within 0.75 inches of the power pin
- Place the 0.1 μ F capacitor within 0.1 inches of the power pin
- Remove the ground plane under and around the part, especially near the input and output pins to reduce parasitic capacitance
- Minimize all trace lengths to reduce series inductances

Refer to the evaluation board layouts below for more information.



Evaluation Board Information

The following evaluation boards are available to aid in the testing and layout of these devices:

Evaluation Board	Products
CEB002	CLC1006IST5X
CEB003	CLC1006ISO8X

Evaluation Board Schematics

Evaluation board schematics and layouts are shown in Figures 9-11. These evaluation boards are built for dual-supply operation. Follow these steps to use the board in a single-supply application:

1. Short -Vs to ground.
2. Use C3 and C4, if the -Vs pin of the amplifier is not directly connected to the ground plane.

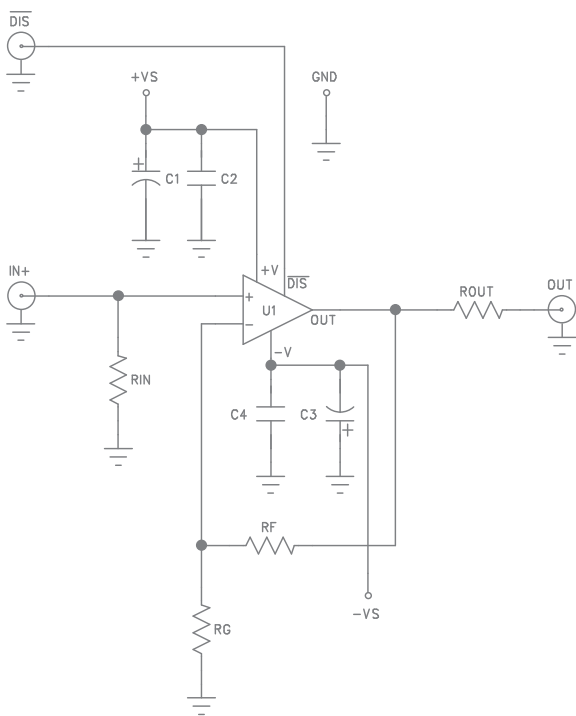

Figure 9. CEB002 Schematic

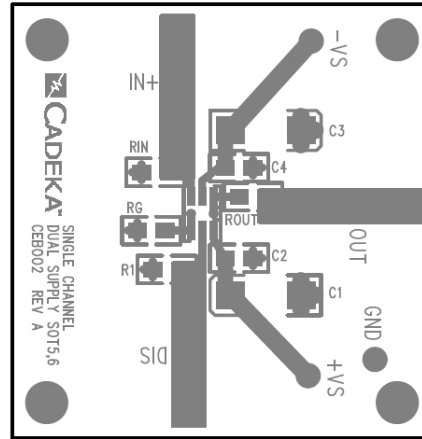

Figure 10. CEB002 Top View

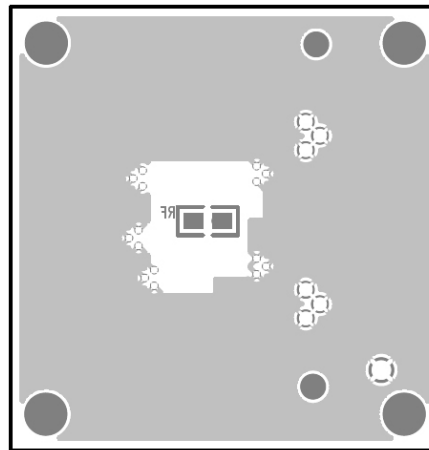

Figure 11. CEB002 Bottom View

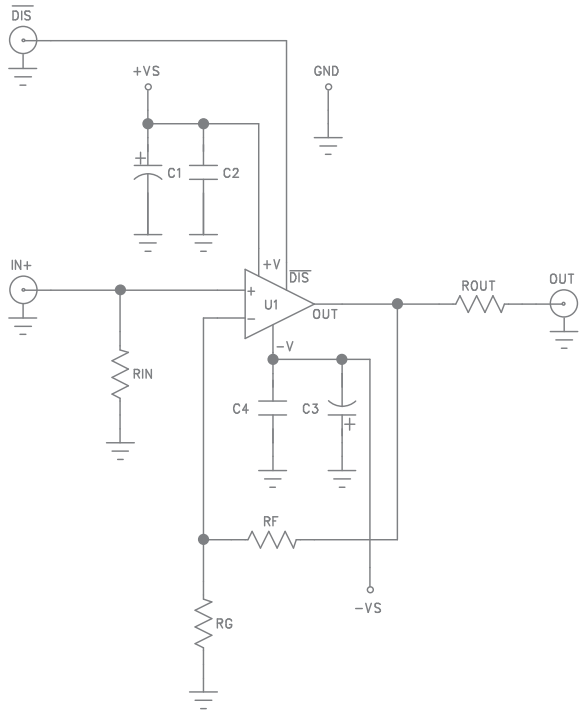

Figure 12. CEB003 Schematic

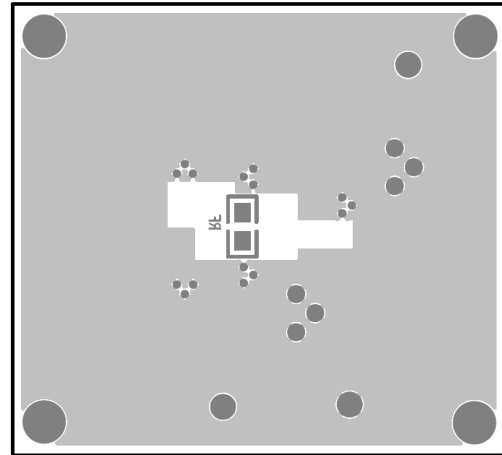

Figure 14. CEB003 Bottom View

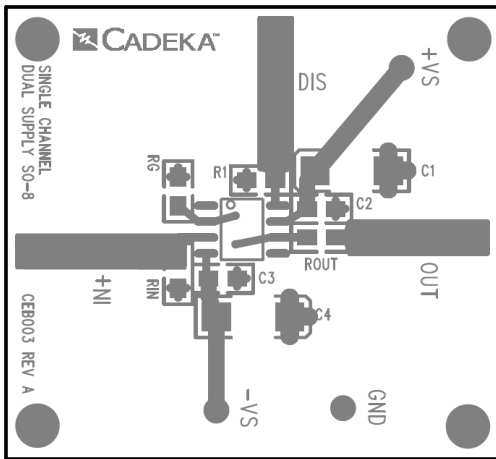
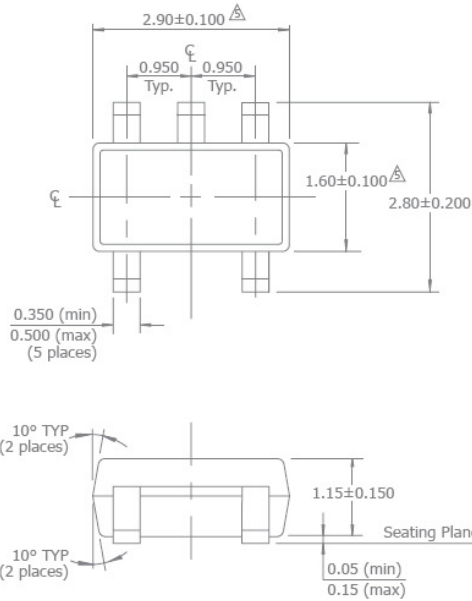

Figure 13. CEB003 Top View



Mechanical Dimensions

SOT23-5 Package



NOTES:

1. Dimensions and tolerances are as per ANSI Y14.5M-1982.
 2. Package surface to be matte finish VDI 11~13.
 3. Die is facing up for mold. Die is facing down for trim/form, ie. reverse trim/form.
 4. The footlength measuring is based on the gauge plane method.
- △ Dimension are exclusive of mold flash and gate burr.
 ▲ Dimension are exclusive of solder plating.

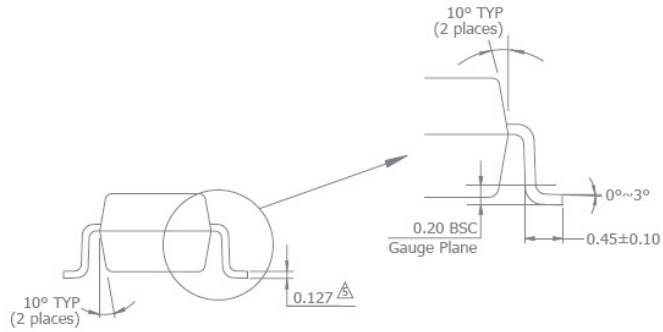

SOIC-8 Package

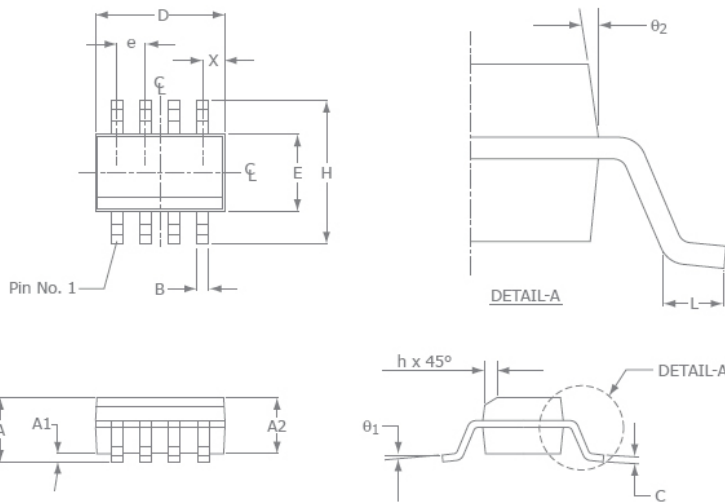

SOIC-8		
SYMBOL	MIN	MAX
A1	0.10	0.25
B	0.36	0.48
C	0.19	0.25
D	4.80	4.98
E	3.81	3.99
e	1.27 BSC	
H	5.80	6.20
h	0.25	0.5
L	0.41	1.27
A	1.37	1.73
θ ₁	0°	8°
X	0.55 ref	
θ ₂	7° BSC	

NOTE:

1. All dimensions are in millimeters.
2. Lead coplanarity should be 0 to 0.1mm (0.004") max.
3. Package surface finishing: VDI 24~27
4. All dimension excluding mold flashes.
5. The lead width, B to be determined at 0.1905mm from the lead tip.

For Further Assistance:

Exar Corporation Headquarters and Sales Offices
 48720 Kato Road Tel.: +1 (510) 668-7000
 Fremont, CA 94538 - USA Fax: +1 (510) 668-7001
 www.exar.com

NOTICE

EXAR Corporation reserves the right to make changes to the products contained in this publication in order to improve design, performance or reliability. EXAR Corporation assumes no responsibility for the use of any circuits described herein, conveys no license under any patent or other right, and makes no representation that the circuits are free of patent infringement. Charts and schedules contained here in are only for illustration purposes and may vary depending upon a user's specific application. While the information in this publication has been carefully checked; no responsibility, however, is assumed for inaccuracies.

EXAR Corporation does not recommend the use of any of its products in life support applications where the failure or malfunction of the product can reasonably be expected to cause failure of the life support system or to significantly affect its safety or effectiveness. Products are not authorized for use in such applications unless EXAR Corporation receives, in writing, assurances to its satisfaction that: (a) the risk of injury or damage has been minimized; (b) the user assumes all such risks; (c) potential liability of EXAR Corporation is adequately protected under the circumstances.

Reproduction, in part or whole, without the prior written consent of EXAR Corporation is prohibited.



A New Direction in Mixed-Signal