

1.5A Low Dropout Voltage Regulator

FEATURES

- Adjustable Output Down to 1.25V
- 1% Output Accuracy
- Output Current of 1.5A
- Low Dropout Voltage of 390mV @ 1.5A
- Extremely Tight Load and Line Regulation
- Extremely Fast Transient Response
- Reverse-Battery Protection
- Zero Current Shutdown (5 pin version)
- Error Flag Signal Output for Out of Regulation State (5 pin version)
- Standard TO-220 and TO-263 Packages

APPLICATIONS

- Powering VGA and Sound Cards
- LCD Monitors
- USB Power Supplies
- PowerPC™ Supplies
- SMPS Post Regulators
- High-efficiency “Green” Computer Systems
- High-efficiency Linear Power Supplies
- Portable Instrumentation
- Constant Current Regulators
- Adjustable Power Supplies
- Battery Chargers

DESCRIPTION

The SPX29150/51/52/53 are 1.5A, highly accurate voltage regulators with a low dropout voltage of 390mV (typical) @ 1.5A. These regulators are specifically designed for low voltage applications that require a low dropout voltage and a fast transient response. They are fully fault protected against over-current, reverse battery, and positive and negative voltage transients. On-chip trimming adjusts the reference voltage to 1% initial accuracy. Other features in the 5 pin versions include Enable and Error Flag.

The SPX29150/51/52/53 is offered in 3-pin and 5-pin TO-220 & TO-263 packages. For a 3A version, refer to the SPX29300 data sheet.

TYPICAL APPLICATION CIRCUITS

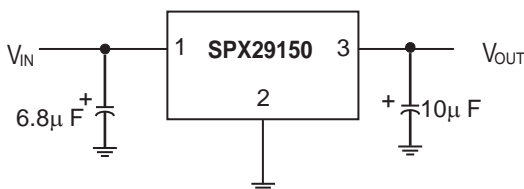

Figure 1. Fixed Output Linear Regulator

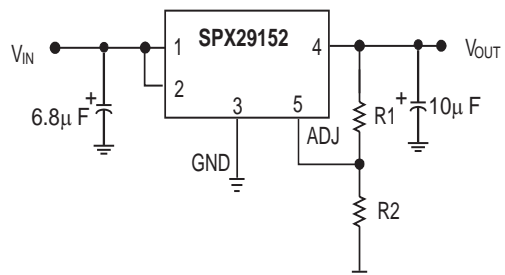

Figure 2. Adjustable Output Linear Regulator

ABSOLUTE MAXIMUM RATINGS

Storage Temperature Range.....-65°C to +150°C

Operating Junction Temperature Range.....-40°C to +125°C

Input Voltage (Note 7).....16V

ELECTRICAL CHARACTERISTICS

at $V_{IN}=V_{OUT} + 1V$ and $I_{OUT} = 10mA$, $C_{IN} = 6.8\mu F$, $C_{OUT} = 10\mu F$, $T_A = 25^\circ C$, unless otherwise specified. The **Boldface** applies over the junction temperature range. Adjustable versions are set to 5.0V.

PARAMETER	CONDITIONS	Typ	SPX29150/51		Units
			Min	Max	
1.8V Version					
Output Voltage	$I_{OUT} = 10mA$ $10mA \leq I_{OUT} \leq 1.5A$, $2.5V \leq V_{IN} \leq 16V$	1.8 1.8	1.782 1.764	1.818 1.836	V
2.5V Version					
Output Voltage	$I_{OUT} = 10mA$ $10mA \leq I_{OUT} \leq 1.5A$, $3.5V \leq V_{IN} \leq 16V$	2.5 2.5	2.475 2.450	2.525 2.550	V
3.3V Version					
Output Voltage	$I_{OUT} = 10mA$ $10mA \leq I_{OUT} \leq 1.5A$, $4.3V \leq V_{IN} \leq 16V$	3.3 3.3	3.267 3.234	3.333 3.366	V
5.0V Version					
Output Voltage	$I_{OUT} = 10mA$ $10mA \leq I_{OUT} \leq 1.5A$, $6.0V \leq V_{IN} \leq 16V$	5.0 5.0	4.950 4.900	5.050 5.100	V
All Voltage Options SPX29150/51/52/53					
Line Regulation	$I_O = 10mA$, $(V_{OUT} + 1V) \leq V_{IN} \leq 16V$	0.1		0.5	%
Load Regulation	$V_{IN} = V_{OUT} + 1V$, $10mA \leq I_{OUT} \leq I_{FULL-LOAD}$	0.2		1	%
$\frac{\Delta V}{\Delta T}$	Output Voltage Temperature Coefficient	13		100	ppm/°C
Dropout Voltage (Note 1) (except 1.8V version)	$I_O = 100mA$	70		200	mV
	$I_O = 750mA$	230			
	$I_O = 1.5A$	390		600	
Ground Current (Note 3)	$I_O = 750mA$, $V_{IN} = V_{OUT} + 1V$	12		25	mA
	$I_O = 1.5A$	45			
IGNDDO Ground Pin Current at Dropout	$V_{IN} = 0.1V$ less than specified V_{OUT} $I_{OUT} = 10mA$	0.9			mA
Current Limit	$V_{OUT} = 0.0V$ (Note 2)	2.2	1.7		A
Output Noise Voltage (10Hz to 100kHz) $I_L = 100mA$	$C_L = 10\mu F$	400			μV_{RMS}
	$C_L = 33\mu F$	260			
Reference Voltage	Adjustable version only	1.240	1.228 1.215	1.252 1.265	V
Reference Voltage	Adjustable version only (Note 8)		1.203	1.277	
Adjust Pin Bias Current		40		80 120	nA
Reference Voltage Temperature Coefficient	(Note 4)	13			ppm/°C
Adjust Pin Bias Current Temperature Coefficient		0.1			nA/°C
Flag Output (Error Comparator) SPX29151/53					
Output Leakage Current	$V_{OH} = 16V$	0.1		1.00 2.00	UA
Output Low Voltage	Device set for 5V, $V_{IN} = 4.5V$, $I_{OL} = 250\mu A$	200		300 400	mV

PARAMETER	CONDITIONS	Typ	SPX29150/51		Units
			Min	Max	
Upper Threshold Voltage	Device set for 5V (Note 5)	60	40 25		mV
Lower Threshold Voltage	Device set for 5V (Note 5)	75		95 140	mV
Hysteresis	Device set for 5V (Note 5)	15			mV
ENABLE input SPX29151/52					
Input Logic Voltage Low (OFF) High (ON)	$V_{IN} < 10V$		2.4V	0.8	V
Enable Input Pin Input Current	$V_{EN}=16V$	100		600 750	μA
	$V_{EN}=0.8V$			1 2	μA
Regulator Output Current in Shutdown	(Note 6)	10		500	μA
Thermal Resistance	TO-220 Junction to Case, at Tab	3			$^{\circ}C/W$
	TO-220 Junction to Ambient	30			
	TO-263 Junction to Case, at Tab	3			
	TO-263 Junction to Ambient	32			

NOTES:

- Note 1: Dropout voltage is defined as the input to output differential when the output voltage drops to 99% of its nominal value.
- Note 2: $V_{IN} = V_{OUT} (NOMINAL) + 1V$. For example, use $V_{IN} = 4.3V$ for a 3.3V regulator. Employ pulse-testing procedures to minimize temperature rise.
- Note 3: Ground pin current is the regulator quiescent current. The total current drawn from the source is the sum of the load current to the ground current.
- Note 4: Thermal regulation is defined as the change in the output voltage at a time T after a change in power dissipation is applied, excluding load or line regulation effects.
- Note 5: Comparator threshold is expressed in terms of a voltage differential at the Adjust terminal below the nominal reference voltage measured 6V input. To express these thresholds in terms of output voltage change, multiply the error amplifier gain = $V_{OUT}/V_{REF} = (R1 + R2)/R2$. For example, at a programmable output voltage of 5V, the Error output is guaranteed to go low when the output drops by $95mV \times 5V / 1.240V = 38mV$. Thresholds remain constant as a percent of V_{OUT} as V_{OUT} is varied, with the dropout warning occurring at typically 5% below nominal, 7.7% guaranteed.
- Note 6: $V_{EN} \leq 0.8V$ and $V_{IN} \leq 16V$, $V_{OUT} = 0$.
- Note 7: Maximum positive supply voltage of 20V must be of limited duration ($<100m_s$) $< 1\%$. The maximum continuous supply voltage is 16V.
- Note 8: $V_{REF} \leq V_{OUT} \leq (V_{IN}-1)$, $2.5V \leq V_{IN} \leq 16V$, $10mA \leq I_L \leq I_{FL}$, $T_J < T_{JMAX}$.

BLOCK DIAGRAM

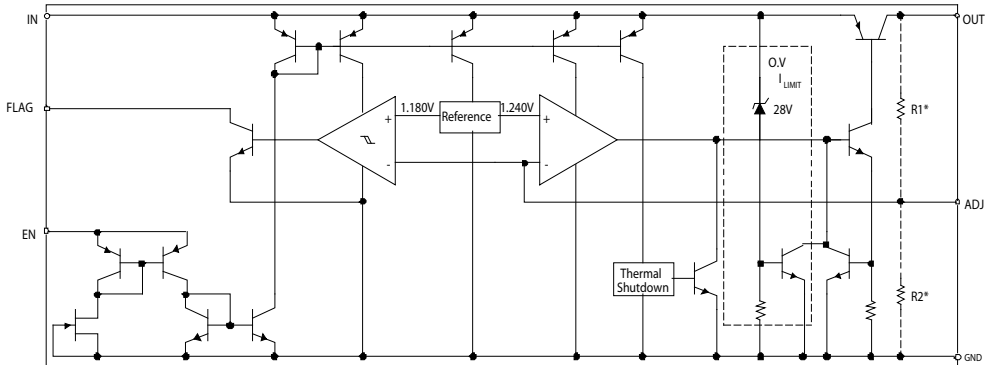

TYPICAL PERFORMANCE CHARACTERISTICS

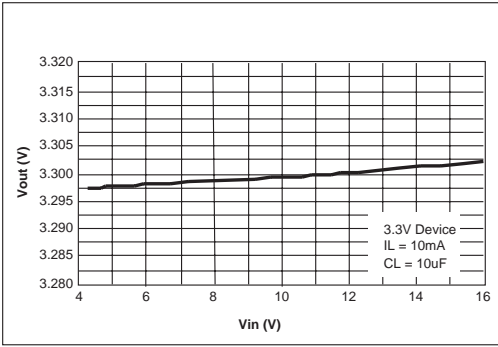

Figure 3. Line Regulation

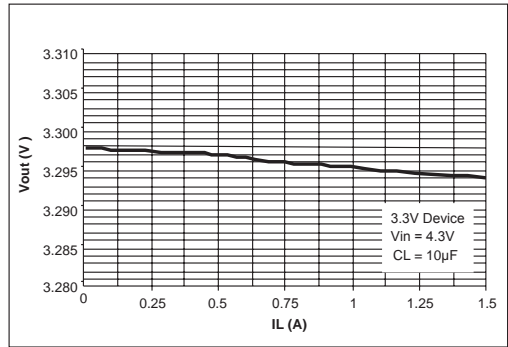

Figure 4. Load Regulation

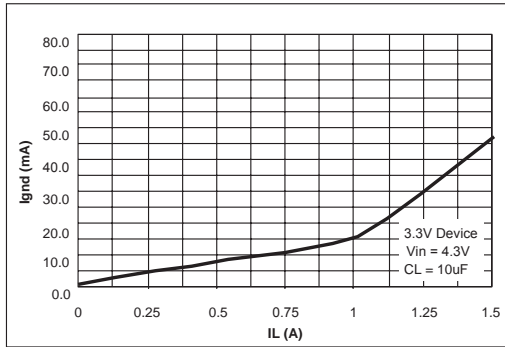

Figure 5. Ground Current vs Load Current

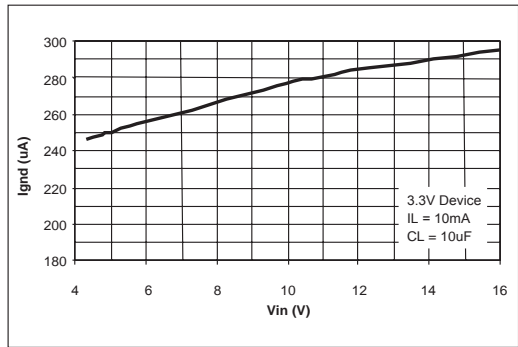

Figure 6. Ground Current vs Input Voltage

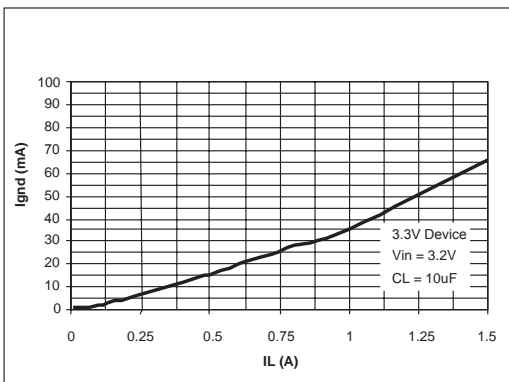

Figure 7. Ground Current vs Load Current in Dropout

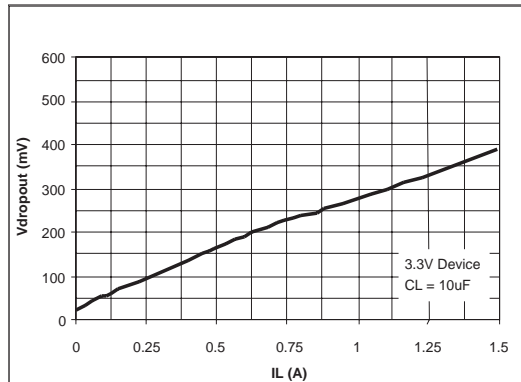

Figure 8. Dropout Voltage vs Load Current

TYPICAL PERFORMANCE CHARACTERISTICS

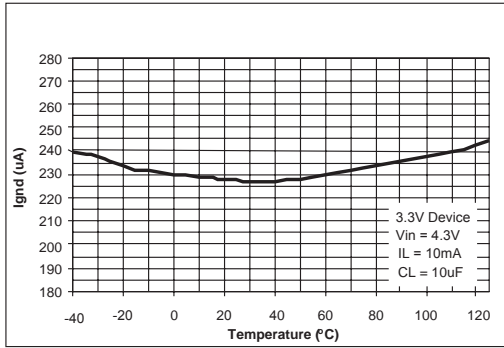

Figure 9. Ground Current vs Temperature at $I_{LOAD}=10mA$

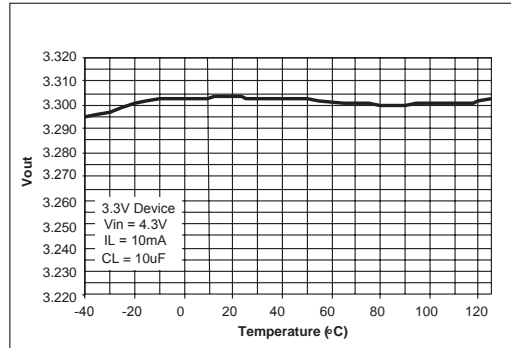

Figure 10. Output Voltage vs Temperature at $I_{LOAD}=10mA$

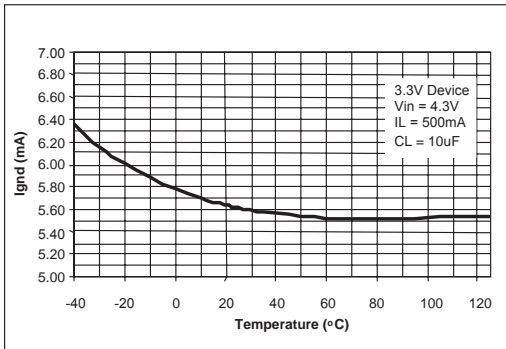

Figure 11. Ground Current vs Temperature at $I_{LOAD}=500mA$

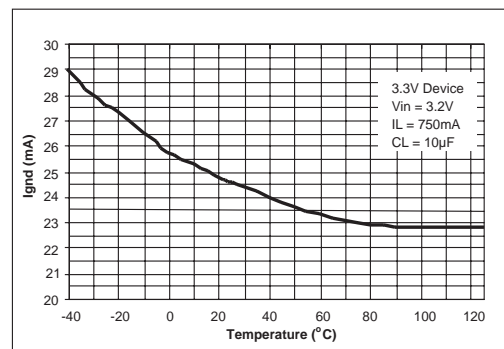

Figure 12. Ground Current vs Temperature in Dropout at $I_{LOAD}=750mA$

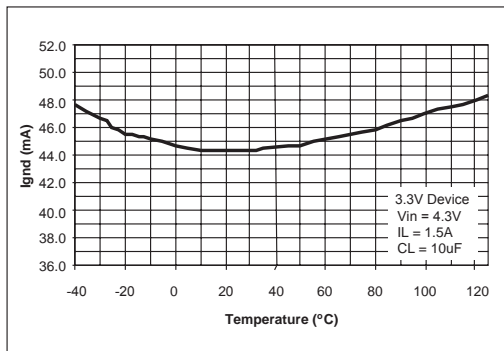

Figure 13. Ground Current vs Temperature at $I_{LOAD}=1.5A$

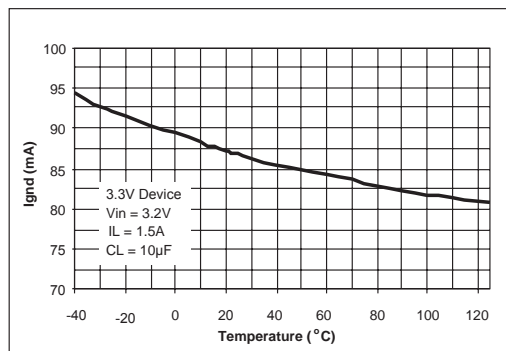

Figure 14. Ground Current vs Temperature in Dropout at $I_{LOAD}=1.5A$

TYPICAL PERFORMANCE CHARACTERISTICS

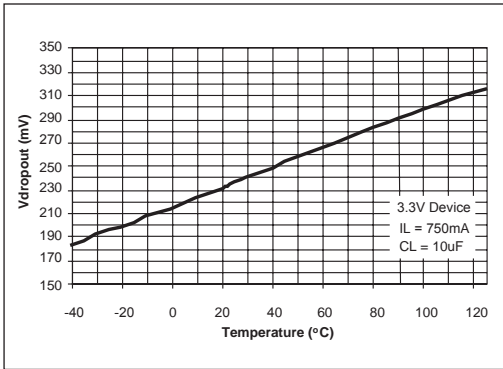

Figure 15. Dropout Voltage vs Temperature at $I_{LOAD}=750mA$

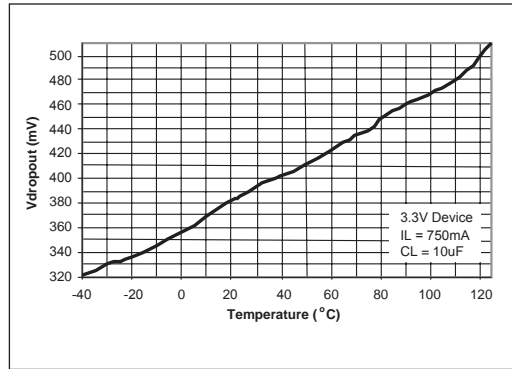

Figure 16. Dropout Voltage vs Temperature at $I_{LOAD}=1.5A$

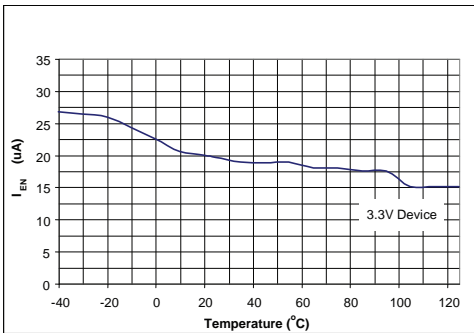

Figure 17. ENABLE Current vs Temperature at $V_{EN}=16V$

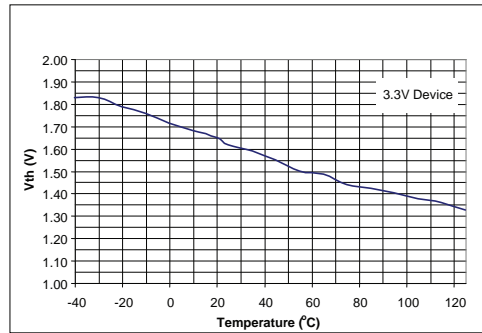

Figure 18. ENABLE Threshold vs Temperature

The SPX29150/51/52/53 incorporates protection against over-current faults, reversed load insertion, over temperature operation, and positive and negative transient voltages.

Thermal Considerations

Although the SPX29150/51/52/53 offers limiting circuitry for overload conditions, it is still necessary to insure that the maximum junction temperature is not exceeded in the application. Heat will flow through the lowest resistance path, the junction-to-case path. In order to insure the best thermal flow of the component, proper mounting is required. Consult the heatsink manufacturer for thermal resistance and heat sink design.

TO-220 Design Example:

Assume that $V_{IN} = 10V$, $V_{OUT} = 5V$, $I_{OUT} = 1.5A$, $T_A = 50^{\circ}C$, $\theta_{H} = 1^{\circ}C/W$, $\theta_{CH} = 2^{\circ}C/W$, and $\theta_{JC} = 3C^{\circ}/W$, where:

T_A = ambient temperature,

θ_{HA} = heatsink to ambient thermal resistance

θ_{CH} = case to heatsink thermal resistance

θ_{JC} = junction to case thermal resistance

The power calculated under these conditions is:

$$P_D = (V_{IN} - V_{OUT}) * I_{OUT} = 7.5W.$$

And the junction temperature is calculated as

$$T_J = T_A + P_D * (\theta_{HA} + \theta_{CH} + \theta_{JC}) \text{ or}$$

$$T_J = 50 + 7.5 * (1+2+3) = 95^{\circ}C$$

Reliable operation is insured.

Capacitor Requirements

The output capacitor is needed to insure stability and minimize the output noise. The value of the capacitor varies with the load. However, a minimum value of 10µF aluminum capacitor will guarantee stability over all load conditions. A tantalum capacitor is recommended if a faster load transient response is needed. If the power source has a high AC impedance, a 0.1µF ceramic capacitor between input & ground is recommended. The output capacitors maximum ESR value for stable operation is 0.33ohms.

Minimum Load Current

To ensure proper behavior of the regulator under light loads, a minimum load of 5mA for SPX29150/51/52/53 is required.

Typical Application Circuits

Figure 19 represents a typical fixed output regulator. Figure 20 represents an adjustable output regulator. The values of R1 and R2 set the output voltage value as follows: $V_{OUT} = V_{REF} * [1 + (R1/R2)]$. A minimum value of 10kΩ is recommended for R2 with a range between 10kΩ and 47kΩ.

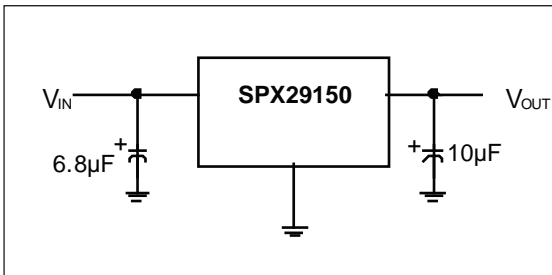

Figure 19. Fixed Output Linear Regulator

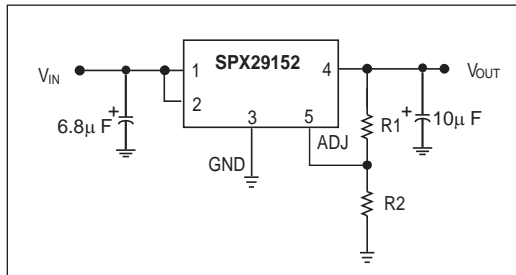
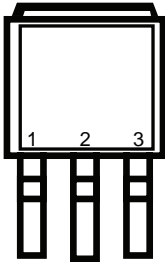

Figure 20. Adjustable Output Linear Regulator

TO-263-3 Package (T)



V_{IN} GND V_{OUT}

Front View

TO-263-5 Package (T5)

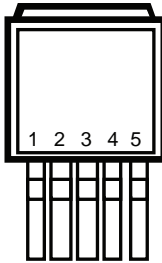

Top View

SPX29151

- 1) ENABLE
- 2) INPUT
- 3) GND
- 4) OUTPUT
- 5) FLAG

SPX29152

- 1) ENABLE
- 2) INPUT
- 3) GND
- 4) OUTPUT
- 5) ADJUST

SPX29153

- 1) FLAG
- 2) INPUT
- 3) GND
- 4) OUTPUT
- 5) ADJUST

*Tab is internally connected to GND

TO-220-3 Package (U)

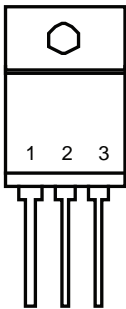

V_{IN} GND V_{OUT}

Front View

TO-220-5 Package (U5)

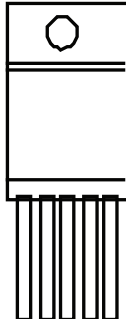

1 2 3 4 5

Top View

SPX29151

- 1) ENABLE
- 2) INPUT
- 3) GND
- 4) OUTPUT
- 5) FLAG

SPX29152

- 1) ENABLE
- 2) INPUT
- 3) GND
- 4) OUTPUT
- 5) ADJUST

SPX29153

- 1) FLAG
- 2) INPUT
- 3) GND
- 4) OUTPUT
- 5) ADJUST

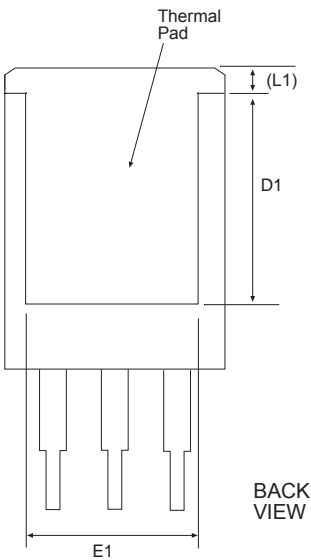
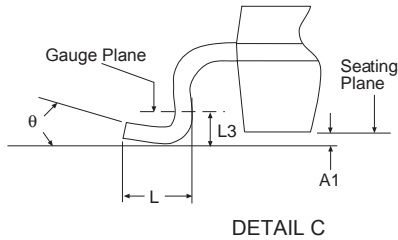
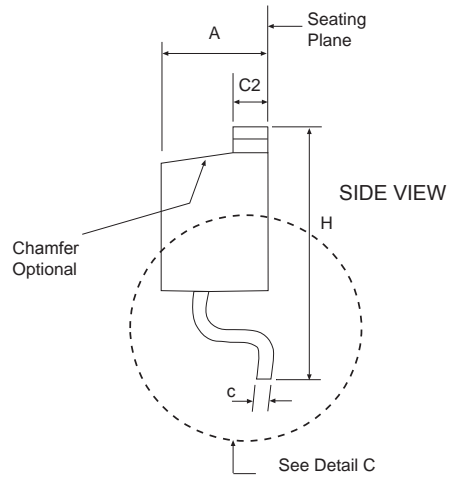
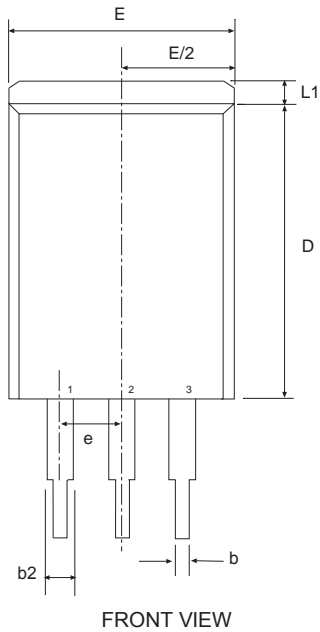

3 Pin TO-263 JEDEC TO-263			Variation AA			
SYMBOL	Inches Controlling Dimension			Millimeters Conversion Factor: 1 Inch = 25.40 mm		
	MIN	NOM	MAX	MIN	NOM	MAX
A	0.160	-	0.190	4.06	-	4.83
A1	0.000	-	0.010	0.00	-	0.25
b	0.020	-	0.039	0.51	-	0.99
b2	0.045	-	0.070	1.14	-	1.78
c	0.015	-	0.029	0.38	-	0.74
c2	0.045	-	0.065	1.14	-	1.65
D	0.330	-	0.380	8.38	-	9.65
D1	0.270	-	-	6.86	-	-
E	0.380	-	0.420	9.65	-	10.67
E1	0.245	-	-	6.22	-	-
e	.100 BSC			2.54 BSC		
H	0.575	-	0.625	14.61	-	15.88
L	0.070	-	0.110	1.78	-	2.79
L1	-	-	0.066	-	-	1.68
L3	.010 BSC			0.25 BSC		
Ø	0°	-	8°	0°	-	8°
EXAR Pkg Signoff Date/Rev:				JL Aug5-05 / Rev A		

PACKAGE: 5 PIN TO-263

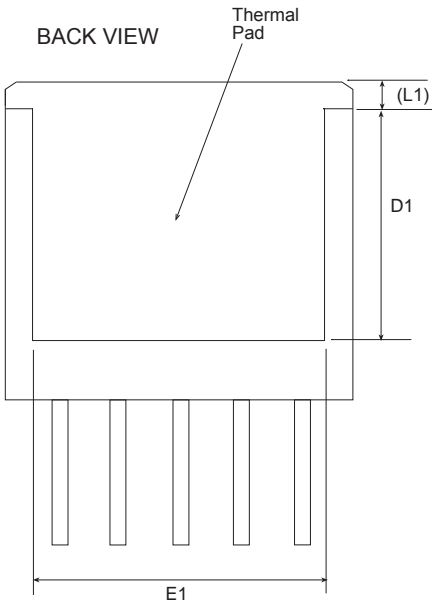
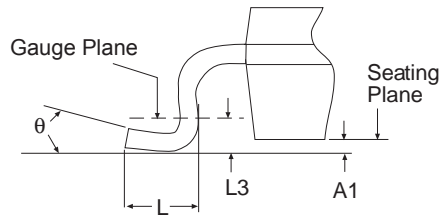
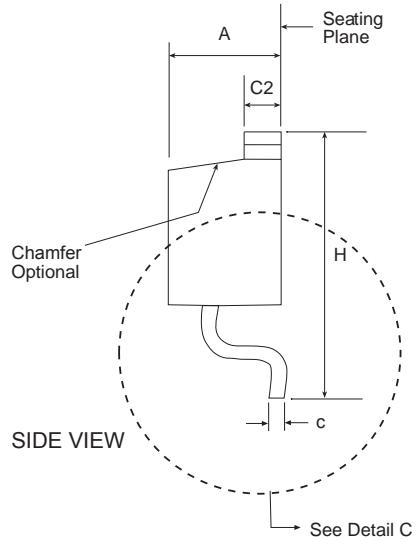
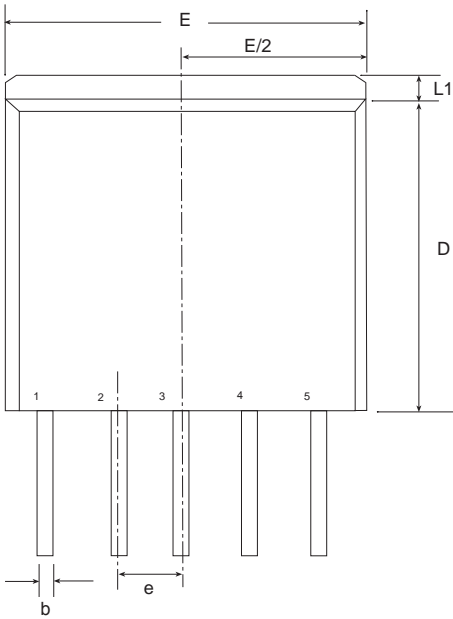

5 Pin TO-263 JEDEC TO-263 Variation BA						
SYMBOL	Dimensions in Inches: Controlling Dimension			Dimensions in Millimeters Conversion Factor: 1 Inch = 25.40 mm		
	MIN	NOM	MAX	MIN	NOM	MAX
A	0.160	-	0.190	4.06	-	4.83
A1	0.000	-	0.010	0.00	-	0.25
b	0.020	-	0.039	0.51	-	0.99
c	0.015	-	0.029	0.38	-	0.74
c2	0.045	-	0.065	1.14	-	1.65
D	0.330	-	0.380	8.38	-	9.65
D1	0.270	-	-	6.86	-	-
E	0.380	-	0.420	9.65	-	10.67
E1	0.245	-	-	6.22	-	-
e	.067 BSC			1.702 BSC		
H	0.575	-	0.625	14.61	-	15.88
L	0.070	-	0.110	1.78	-	2.79
L1	-	-	0.066	-	-	1.68
L3	.010 BSC			0.254 BSC		
θ	0°	-	8°	0°	-	8°
EXAR Pkg Signoff Date/Rev:				JL Jun12-06 / Rev B		

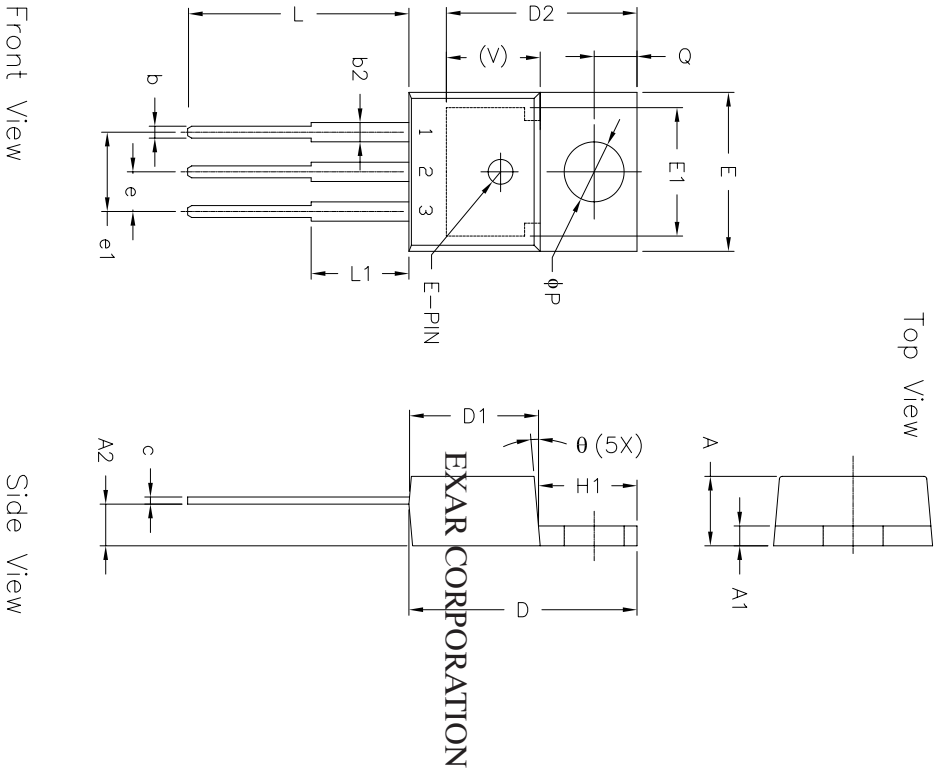

REVISION HISTORY			
REV.	DESCRIPTION	DATE	APP'D
A	DRAWING ORIGINATOR	09/04/05	JL
B	DRAWING FORMAT MODIFICATION	05/25/06	JL

3 Pin TO-220 (Option 1)* JEDEC TO-220-AB		DIMENSIONS IN INCH (Control Unit)		DIMENSIONS IN MM (Reference Unit)	
SYMBOLS	MIN	MAX	MIN	MAX	MAX
A	0.140	0.190	3.56	4.82	
A1	0.020	0.055	0.51	1.40	
A2	0.080	0.115	2.03	2.92	
b	0.015	0.040	0.38	1.02	
c	0.014	0.024	0.36	0.61	
D	0.560	0.650	14.22	16.51	
D1	0.330	0.355	8.38	9.02	
D2	0.480	0.507	12.19	12.88	
E	0.380	0.420	9.65	10.67	
E1	0.270	0.350	6.86	8.89	
e	0.100 BSC		2.54 BSC		
e1	0.200 BSC		5.08 BSC		
H1	0.230	0.270	5.84	6.86	
L	0.500	0.580	12.70	14.73	
L1	—	0.250	—	6.35	
P	0.139	0.156	3.53	3.96	
Q	0.103	0.113	2.62	2.87	
V	0.240 REF		6.10 REF		
θ	3°	7°	3°	7°	
N	3		3		

* Refer to product datasheet for POD option being used

		SIPLEX CORPORATION	
Packaging Approval:		Drawing No:	
Bpr: JL	Date: 05/25/06	3 PIN TO-220 PACKAGE OUTLINE	3-PIN TO-220
		Revision: B	Sheet: 1 OF 2

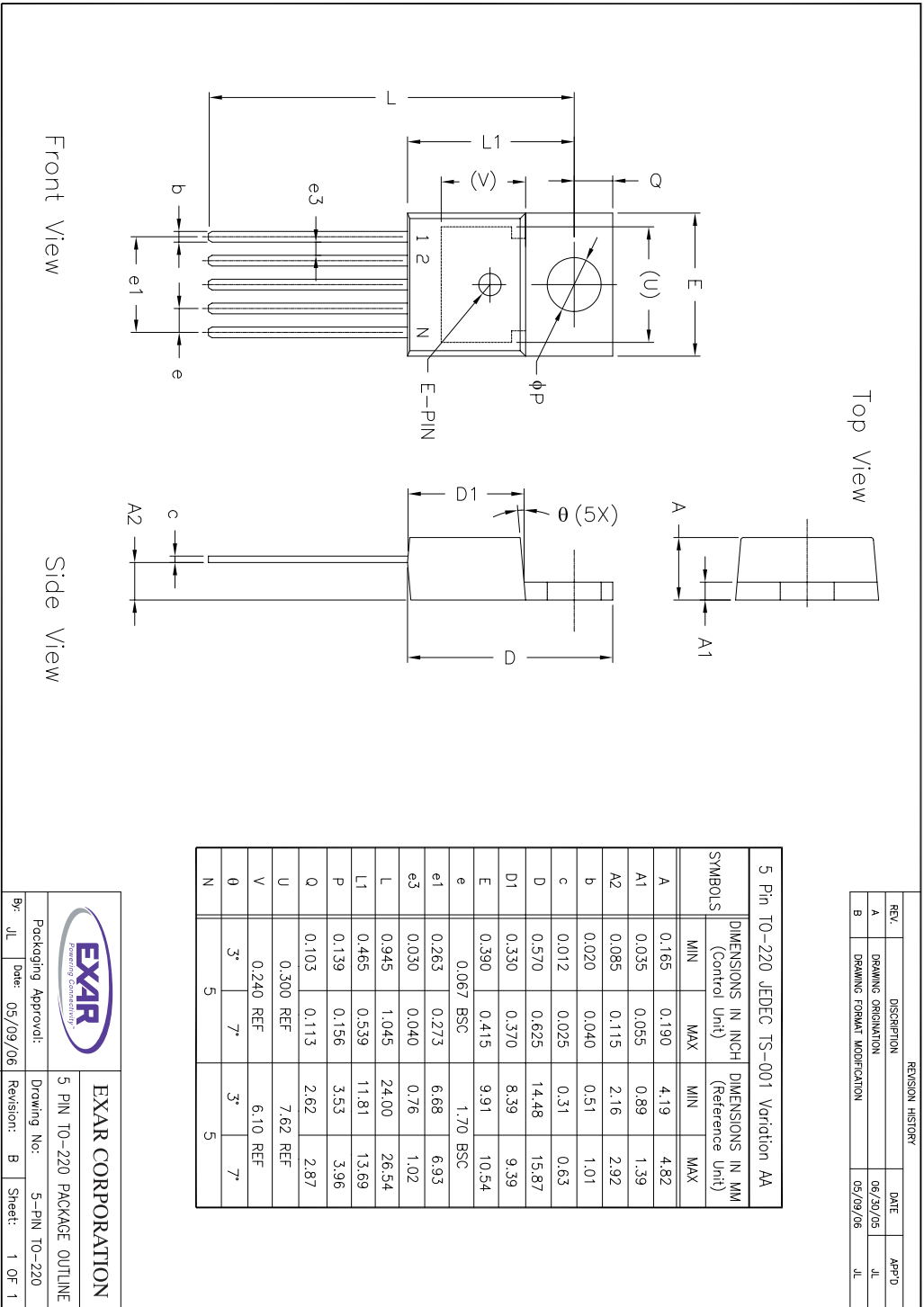

REVISION HISTORY			
REV.	DISCRIPTION	DATE	APP'D
A	DRAWING ORIGINATOR	06/30/05	JL
B	DRAWING FORMAT MODIFICATION	05/09/06	JL

5 Pin TO-220 JEDEC TS-001 Variation AA				
SYMBOLS	DIMENSIONS IN INCH (Control Unit)		DIMENSIONS IN MM (Reference Unit)	
	MIN	MAX	MIN	MAX
A	0.165	0.190	4.19	4.82
A1	0.035	0.055	0.89	1.39
A2	0.085	0.115	2.16	2.92
b	0.020	0.040	0.51	1.01
c	0.012	0.025	0.31	0.63
D	0.570	0.625	14.48	15.87
D1	0.330	0.370	8.39	9.39
E	0.390	0.415	9.91	10.54
e	0.067 BSC		1.70 BSC	
e1	0.263	0.273	6.68	6.93
e3	0.030	0.040	0.76	1.02
L	0.945	1.045	24.00	26.54
L1	0.465	0.539	11.81	13.69
P	0.139	0.156	3.53	3.96
Q	0.103	0.113	2.62	2.87
U	0.300 REF		7.62 REF	
V	0.240 REF		6.10 REF	
θ	3°	7°	3°	7°
N	5		5	

		EXAR CORPORATION <small>Powering Systems™</small>	
Packaging Approval:		Drawing No:	
By: JL	Date: 05/09/06	Revision: B	Sheet: 1 Of 1
5 PIN TO-220 PACKAGE OUTLINE		5-PIN TO-220	

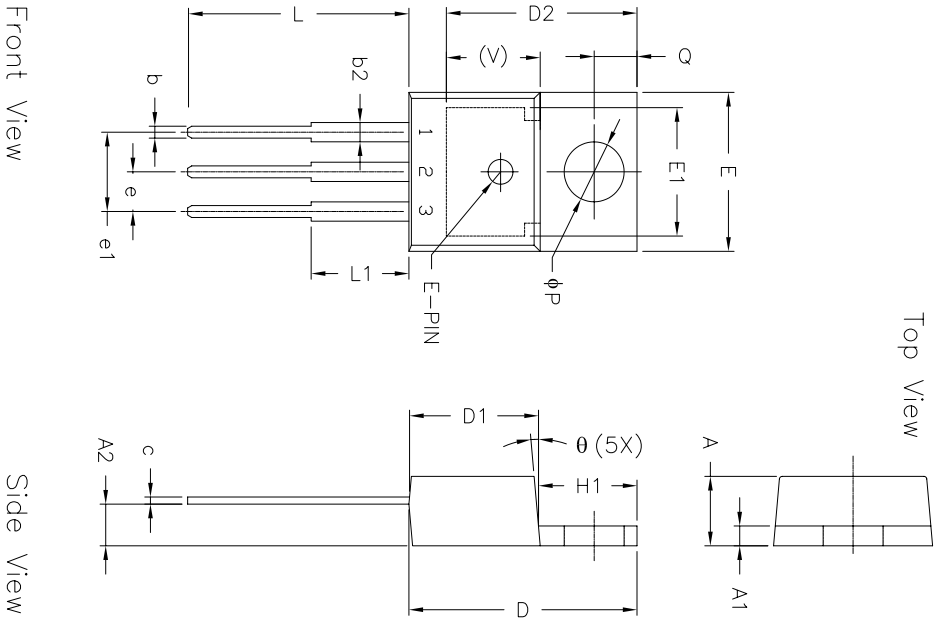

REVISION HISTORY		DATE	APP'D
REV/	DESCRIPTION		
A	DRAWING ORIGINATOR	09/04/05	JL
B	DRAWING FORMAT MODIFICATION	05/25/06	JL

SYMBOLS	DIMENSIONS IN INCH (Control Unit)		DIMENSIONS IN MM (Reference Unit)	
	MIN	MAX	MIN	MAX
A	0.140	0.190	3.56	4.82
A1	0.020	0.055	0.51	1.40
A2	0.080	0.115	2.03	2.92
b	0.015	0.040	0.38	1.02
c	0.014	0.024	0.36	0.61
D	0.560	0.650	14.22	16.51
D1	0.330	0.355	8.38	9.02
D2	0.480	0.507	12.19	12.88
E	0.380	0.420	9.65	10.67
E1	0.270	0.350	6.86	8.89
e	0.100 BSC		2.54 BSC	
e1	0.200 BSC		5.08 BSC	
H1	0.230	0.270	5.84	6.86
L	0.500	0.580	12.70	14.73
L1	—	0.250	—	6.35
P	0.139	0.156	3.53	3.96
Q	0.103	0.113	2.62	2.87
V	0.240 REF		6.10 REF	
θ	3°	7°	3°	7°
N	3		3	

* Refer to product datasheet for POD option being used

		SIPLEX CORPORATION	
Packaging Approval:		3 PIN TO-220 PACKAGE OUTLINE	
Drawing No:	3-PIN TO-220	Revision:	B
By:	JL	Date:	05/25/06
		Sheet:	1 OF 2