

GENERAL DESCRIPTION

The XRP2997 is a Double Data Rate (DDR) termination voltage regulator supporting all power requirements of DDR I, II and III memories and is capable of sinking or sourcing 2A continuously.

Tightly regulating its output voltage within $\pm 20\text{mV}$, the XRP2997 converts input voltages as low as 1.1V while the output voltage is adjustable through an external resistor divider or by forcing the V_{REF} pin voltage. It maintains a fast line and load transient response and only requires an output capacitance of $22\mu\text{F}$ to operate. An enable function via an external MOSFET and a soft start feature allow for a controlled implementation of power-up sequencing.

Built-in source/sink overcurrent, over-temperature and under-voltage lockout protections insure safe operation under abnormal operating conditions.

The XRP2997 meets JEDEC SSTL-2, SSTL-18, HSTL, SCSI-1 and SCSI-3 specifications for DDR SDRAM memories.

The XRP2997 is offered in a RoHS compliant, "green"/halogen free 8-pin Exposed Pad SOIC package.

APPLICATIONS

- **DDR I/II/III Memory Termination**
- **Active Termination Buses**
- **Audio-Video Equipments**
- **Video-Graphics Cards**

FEATURES

- **DDR1, DDR2 and DDR3 Support**
 - $0.75V_{\text{TT}}$ Generation
 - $\pm 20\text{mV}$ Output Voltage Offset
- **2 Amps Continuous Current Sourcing & Sinking**
 - 1.1V to 5.5V Wide Input Voltage Range
- **Adjustable Output Voltage**
- **Suspend to RAM(STR), Enable & Soft Start Functions**
- **Stable with $22\mu\text{F}$ Ceramic Capacitor**
- **UVLO, Over Temperature and Over Current Protections**
- **Minimal External Components**
- **Pin/Function Compatible with SP2996B**
- **RoHS Compliant "Green"/Halogen Free 8-Pin SOIC Package**

TYPICAL APPLICATION DIAGRAM

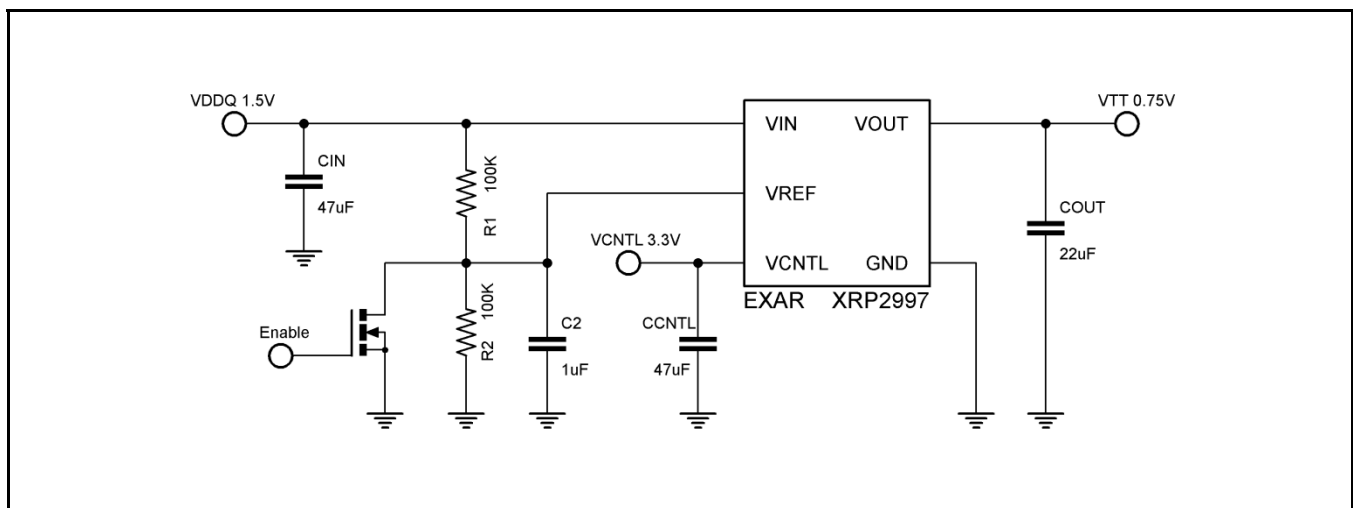

Fig. 1: XRP2997 DDRIII V_{TT} Application Diagram



ABSOLUTE MAXIMUM RATINGS

These are stress ratings only and functional operation of the device at these ratings or any other above those indicated in the operation sections of the specifications below is not implied. Exposure to absolute maximum rating conditions for extended periods of time may affect reliability.

$V_{IN}, V_{REF}, V_{CNTL}$ -0.3V to 6.0V
 Junction Temperature Range..... -40°C to +150°C
 Storage Temperature..... -65°C to +150°C
 Lead Temperature (Soldering, 10 sec) 260°C

OPERATING RATINGS

Operating Temperature Range..... -40°C to +85°C
 Thermal Resistance θ_{JA} 60°C/W
 Thermal Resistance θ_{JC} 16°C/W

ELECTRICAL SPECIFICATIONS

Specifications are for an Operating Ambient Temperature of $T_A = 25^\circ\text{C}$ only; limits applying over the full Operating Junction Temperature range are denoted by a "•". Minimum and Maximum limits are guaranteed through test, design, or statistical correlation. Typical values represent the most likely parametric norm at $T_A = 25^\circ\text{C}$, and are provided for reference purposes only. Unless otherwise indicated, $V_{IN} = 1.8\text{V}/1.5\text{V}$, $V_{CNTL} = 3.3\text{V}$, $V_{REF} = 0.5 \times V_{IN}$, $C_{OUT} = 22\mu\text{F}$ (ceramic), $T_A = 25^\circ\text{C}$.

Parameter	Min.	Typ.	Max.	Units	Conditions
V_{IN} , Input Voltage Range	1.1	1.8/1.5	5.5	V	Keep $V_{CNTL} \geq V_{IN}$ during power on and power off sequences (note 4)
V_{CNTL} , Input Voltage Range	2.375	3.3	5.5	V	Keep $V_{CNTL} \geq V_{IN}$ during power on and power off sequences (note 4)
V_{OUT} , Output Voltage	V_{REF}			V	$I_{OUT} = 0\text{mA}$
V_{OS} , Output Voltage Offset	-20		+20	mV	$I_{OUT} = 0\text{mA}$ (note 1)
ΔV_{LOR} , Load Regulation	-20		+20	mV	$I_{OUT} = 0.1\text{mA}$ to +2A
	-20		+20	mV	$I_{OUT} = 0.1\text{mA}$ to -2A
I_{Q} , Quiescent Current		2	90	μA	$V_{REF} < 0.2\text{V}$, $V_{OUT} = \text{OFF}$
I_{CNTL} , Operating Current of V_{CNTL}		1	2.5	mA	$I_{OUT} = 0\text{mA}$
I_{REF} , Bias Current of V_{REF}	0		1	μA	$V_{REF} = 1.25\text{V}$
I_{IL} , Current Limit	2.4	3		A	Source: $V_{OUT} = 0.33 \times V_{REF}$ Sink: $V_{OUT} = 0.95 \times V_{IN}$ (note 3)
R_{DSCHG} , Output Discharge Resistance		18	25	Ω	$V_{REF} = 0\text{V}$, $V_{OUT} = 0.3\text{V}$
Thermal Protection					
T_{SD} , Thermal Shutdown Temperature		160		$^\circ\text{C}$	$3.3\text{V} \leq V_{CNTL} \leq 5\text{V}$, guaranteed by design (note 4)
Thermal Shutdown Hysteresis		30		$^\circ\text{C}$	Guaranteed by design
Shutdown Specifications					
$V_{TRIGGER}$, Shutdown Threshold	0.8			V	Output ON $V_{REF} = 0\text{V} \rightarrow 1.25\text{V}$
			0.2		Output OFF $V_{REF} = 1.25\text{V} \rightarrow 0\text{V}$

Note 1: V_{OS} offset is the voltage measurement defined as V_{OUT} subtracted from V_{REF} .
 Note 2: Load regulation is measured at constant junction temperature, using pulse testing with a short ON time.
 Note 3: Current limit is measured by applying a short duration current pulse.
 Note 4: In order to safely operate your system, V_{CNTL} must be $> V_{IN}$.

BLOCK DIAGRAM

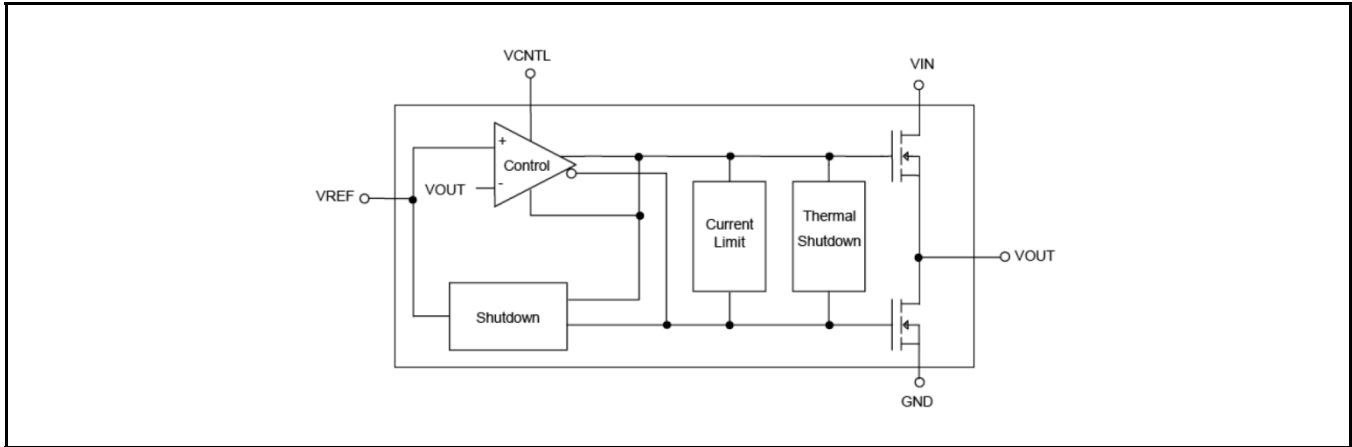

Fig. 2: XRP2997 Block Diagram

PIN ASSIGNMENT

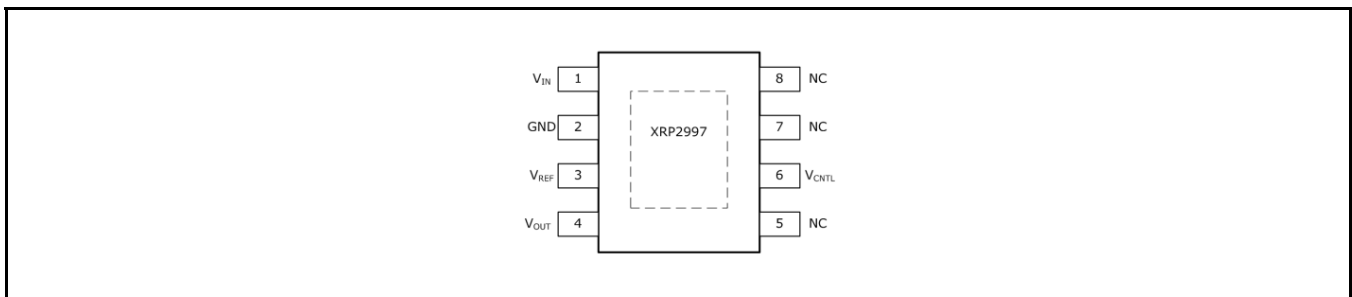

Fig. 3: XRP2997 Pin Assignment

PIN DESCRIPTION

Name	Pin Number	Description
V_{IN}	1	Power Input Voltage
GND	2	Ground Signal
	Exposed Pad	
V_{REF}	3	Reference Input Voltage. This input can also be used as an enable signal; pulling this pin low shuts down the XRP2997. Refer to typical application circuit.
V_{OUT}	4	Output Voltage
NC	5, 7, 8	NC
V_{CTRL}	6	Voltage for the driver circuit and all analog blocks

ORDERING INFORMATION

Part Number	Temperature Range	Marking	Package	Packing Quantity	Note 1	Note 2
XRP2997IDB-F/TR	$-40^{\circ}\text{C} \leq T_A \leq +85^{\circ}\text{C}$	XRP2997I YYWWF XXXXXX	Exposed pad SOIC-8	2.5K/Tape & Reel	RoHS Compliant Halogen Free	

“YY” = Year - “WW” = Work Week - “L” = Lead Free Indicator - “X” = Lot Number; when applicable.

TYPICAL PERFORMANCE CHARACTERISTICS

All data taken at $V_{IN} = 1.8V/1.5V$, $V_{CNTL} = 3.3V$, $V_{REF} = 0.5 \times V_{IN}$, $C_{OUT} = 22\mu F$ (ceramic), $T_A = 25^\circ C$, unless otherwise specified - Schematic and BOM from Application Information section of this datasheet.

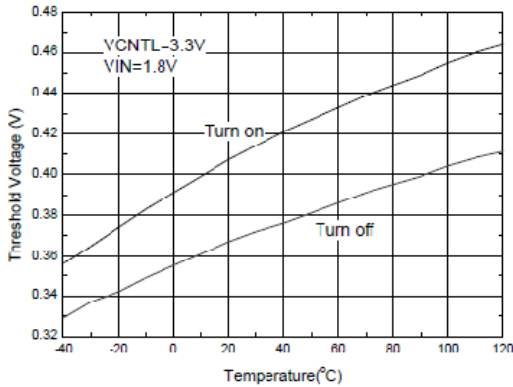

Fig. 4: Turn on and turn off vs. Temperature

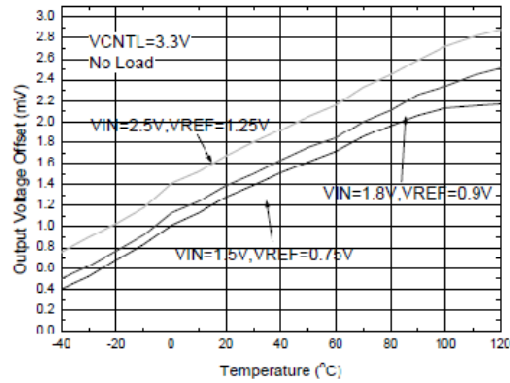

Fig. 5: Output Voltage vs. Temperature

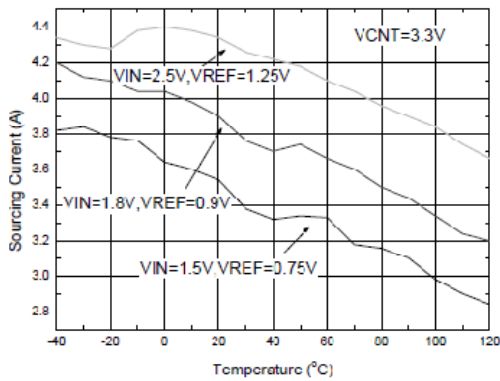

Fig. 6: Current limit (sourcing) vs. Temperature

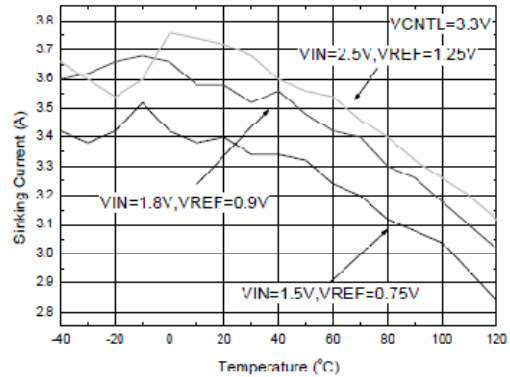

Fig. 7: Current limit (sinking) vs. Temperature

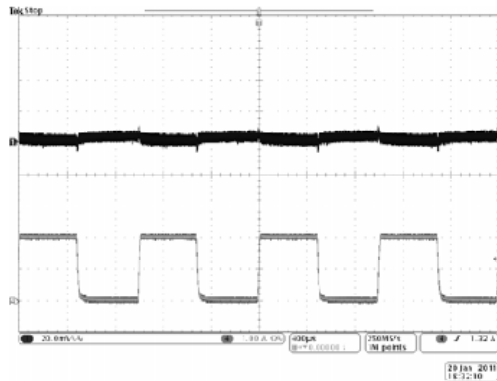

Fig. 8: $V_{IN}=1.5V$, $V_{REF}=0.75V$ source response

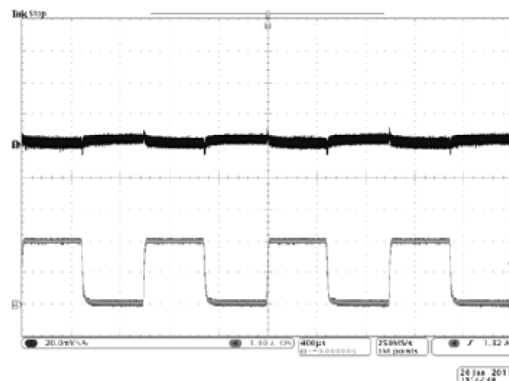

Fig. 9: $V_{IN}=1.8V$, $V_{REF}=0.9V$ source response

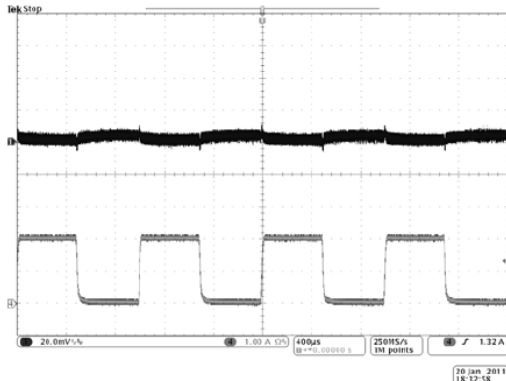

Fig. 10: $V_{IN}=2.5V$, $V_{REF}=1.25V$ source response

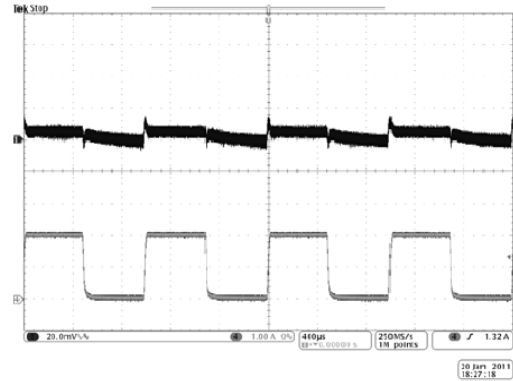

Fig. 11: $V_{IN}=1.5V$, $V_{REF}=0.75V$ sink response

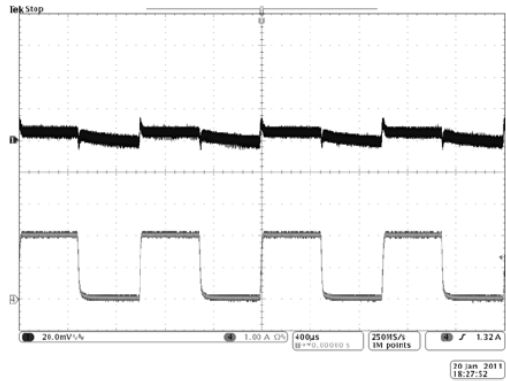

Fig. 9: $V_{IN}=1.8V$, $V_{REF}=0.9V$ sink response

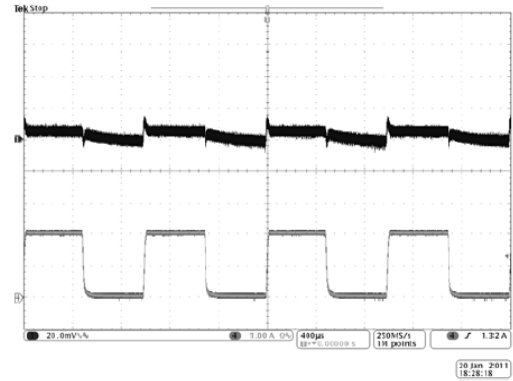

Fig. 10: $V_{IN}=2.5V$, $V_{REF}=1.25V$ sink response

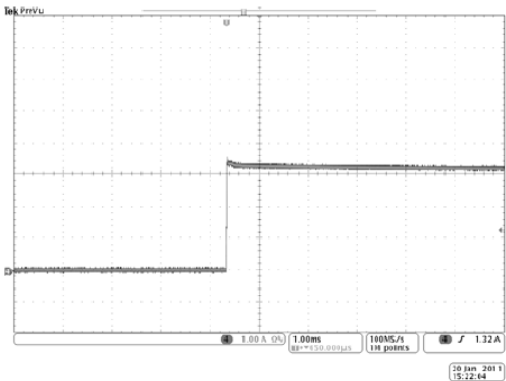

Fig. 14: $V_{IN}=1.5V$, $V_{REF}=0.75V$ source short circuit

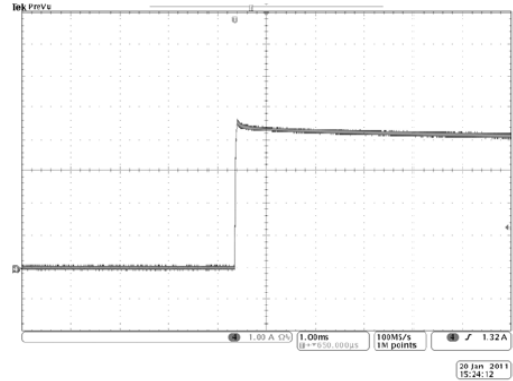

Fig. 15: $V_{IN}=1.8V$, $V_{REF}=0.9V$ source short circuit

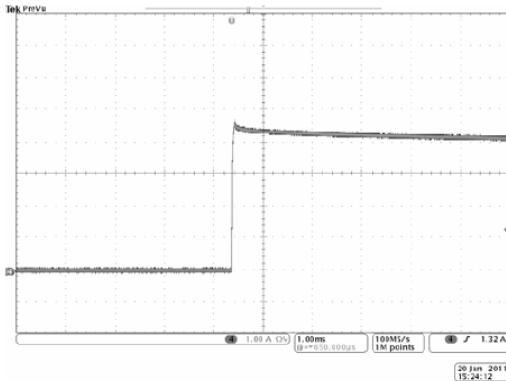

Fig. 11: $V_{IN}=2.5V$, $V_{REF}=1.25V$ source short circuit

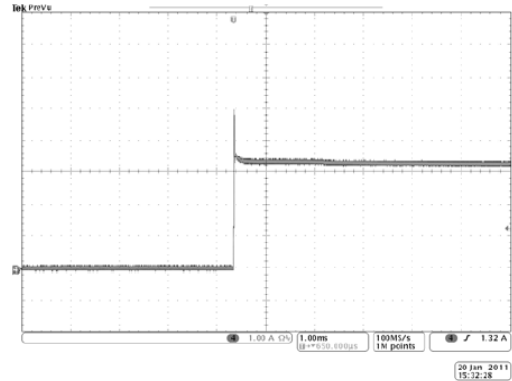

Fig. 12: $V_{IN}=1.5V$, $V_{REF}=0.75V$ sink short circuit

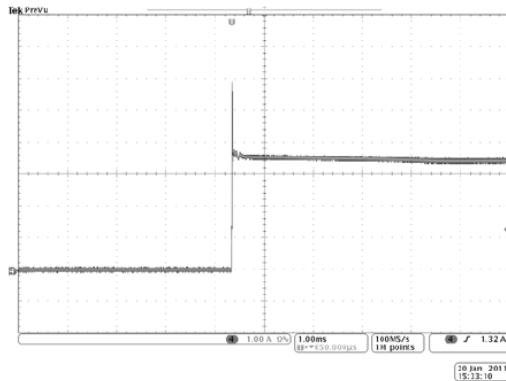

Fig. 13: $V_{IN}=1.8V$, $V_{REF}=0.9V$ sink short circuit

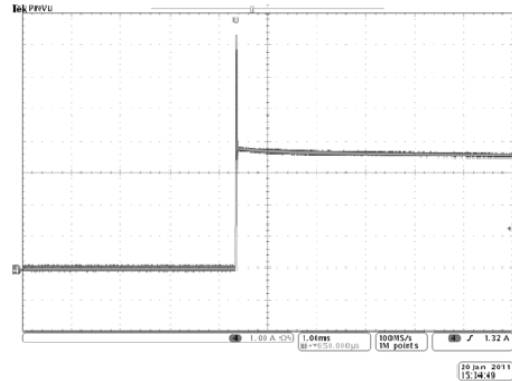

Fig. 14: $V_{IN}=2.5V$, $V_{REF}=1.25V$ sink short circuit

APPLICATION INFORMATION

LAYOUT CONSIDERATIONS

The XRP2997 is offered in the 8-pin exposed-pad SOIC package in order to facilitate power dissipation (heat dissipation). Power dissipation can be maximized by soldering the

exposed pad to a large land area on top layer of PCB and by using vias to connect the exposed pad to an interlayer(s) or bottom layer. All capacitors should be placed as close as possible to the respective pins.

PACKAGE SPECIFICATION

8-PIN SOIC EXPOSED PAD

Unit: mm (inch)

Eject hole, oriented hole and mold mark are optional.

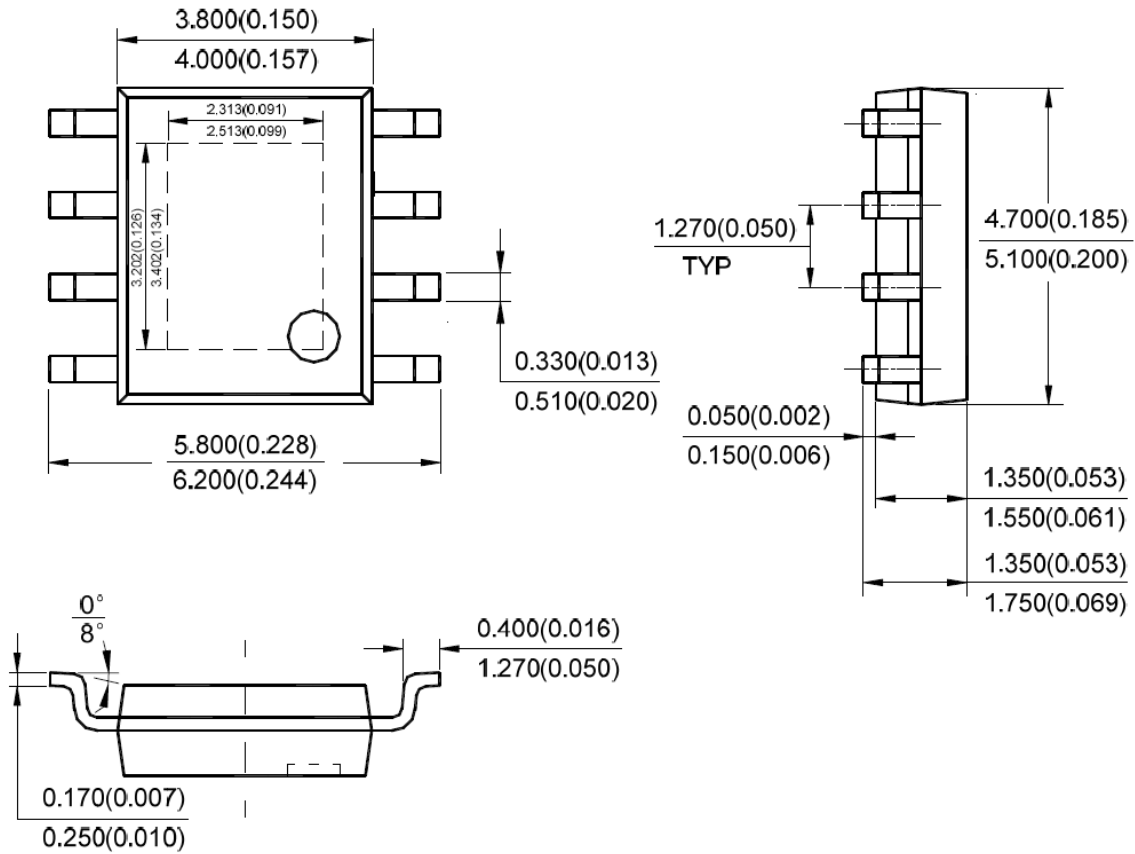



REVISION HISTORY

Revision	Date	Description
1.0.0	07/22/2011	Initial release of datasheet

FOR FURTHER ASSISTANCE

Email:

customersupport@exar.com

Exar Technical Documentation:

<http://www.exar.com/TechDoc/default.aspx?>

EXAR CORPORATION

HEADQUARTERS AND SALES OFFICES

48720 Kato Road

Fremont, CA 94538 – USA

Tel.: +1 (510) 668-7000

Fax: +1 (510) 668-7030

www.exar.com



NOTICE

EXAR Corporation reserves the right to make changes to the products contained in this publication in order to improve design, performance or reliability. EXAR Corporation assumes no responsibility for the use of any circuits described herein, conveys no license under any patent or other right, and makes no representation that the circuits are free of patent infringement. Charts and schedules contained herein are only for illustration purposes and may vary depending upon a user's specific application. While the information in this publication has been carefully checked; no responsibility, however, is assumed for inaccuracies.

EXAR Corporation does not recommend the use of any of its products in life support applications where the failure or malfunction of the product can reasonably be expected to cause failure of the life support system or to significantly affect its safety or effectiveness. Products are not authorized for use in such applications unless EXAR Corporation receives, in writing, assurances to its satisfaction that: (a) the risk of injury or damage has been minimized; (b) the user assumes all such risks; (c) potential liability of EXAR Corporation is adequately protected under the circumstances.

Reproduction, in part or whole, without the prior written consent of EXAR Corporation is prohibited.