

GENERAL DESCRIPTION

The SP6203 and SP6205 are ultra low noise CMOS LDOs with very low dropout and ground current. The noise performance is achieved by means of an external bypass capacitor without sacrificing turn-on and turn-off speed critical to portable applications. Extremely stable and easy to use, these devices offer excellent PSRR and Line/Load regulation. Target applications include battery-powered equipment such as portable and wireless products. Regulators' ground current increases only slightly in dropout. Fast turn-on/turn-off enable control and an internal 30Ω pull down on output allows quick discharge of output even under no load conditions. Both LDOs are protected with current limit and thermal shutdown.

Both LDOs are available in fixed & adjustable output voltage versions and come in an industry standard 5-pin SOT-23 and small 2X3mm 8-pin DFN packages. For SC-70 100mA CMOS LDO, SP6213 is available.

APPLICATIONS

- **Battery-Powered Systems**
- **Medical Equipments**
- **MP3/CD Players**
- **Digital Cameras**

FEATURES

- **300mA/500mA Output Current**
 - SP6203: 300mA – SP6205: 500mA
 - Low Dropout Voltage: 0.6Ω PMOS FET
- **2.7V to 5.5V Input Voltage**
 - Fixed and Adjustable Output Voltage
 - Accurate Output Voltage: 2% over Temp.
- **67dB Power Supply Rejection Ratio**
- **$12\mu\text{V}_{\text{RMS}}$ Low Output Noise**
- **Unconditionally Stable with 2.2 μF Ceramic**
- **Low Quiescent Current: 5 μA**
- **Low Ground Current: 350 μA at 500mA**
- **Fast Turn-On and Turn-Off: 60 μs**
- **Very Good Load/Line Regulation: 0.07/0.0 %**
- **Current Limit and Thermal Protection**
- **RoHS Compliant "Green"/Halogen Free 5-Pin SOT23 and 8-Pin DFN Packages**

TYPICAL APPLICATION DIAGRAM

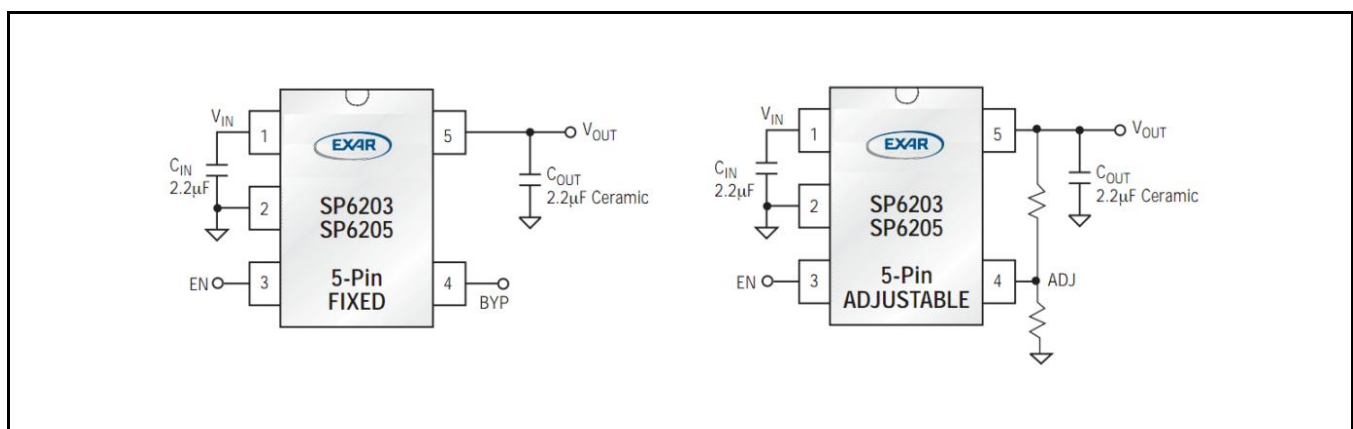

Fig. 1: SP6203/SP6205 Application Diagram



SP6203 / SP6205

300mA/500mA Low Noise CMOS LDO Regulators

ABSOLUTE MAXIMUM RATINGS

These are stress ratings only and functional operation of the device at these ratings or any other above those indicated in the operation sections of the specifications below is not implied. Exposure to absolute maximum rating conditions for extended periods of time may affect reliability.

V _{IN}	-2V to 6.0V
Output Voltage V _{OUT}	-0.6V to V _{IN} +1V
Enable Input Voltage V _{EN}	-2V to 6V
Storage Temperature	-65°C to 150°C
Power Dissipation	Internally Limited ¹
Lead Temperature (Soldering, 5 sec)	+260°C
Junction Temperature	+150°C

OPERATING RATINGS

Input Voltage Range V _{IN}	+2.7V to +5.5V
Enable Input Voltage V _{EN}	0 to 5.5V
Junction Temperature Range	-40°C to +125°C
Thermal Resistance	
SOT-23-5 (θ _{JA})	191°C/W
DFN-8 (θ _{JA})	59°C/W

Note 1: Maximum power dissipation can be calculated using the formula: PD = (T_{J(max)} - T_A) / θ_{JA}, where T_{J(max)} is the junction temperature, T_A is the ambient temperature and θ_{JA} is the junction-to-ambient thermal resistance. θ_{JC} is 6°C/W for this package. Exceeding the maximum allowable power dissipation will result in excessive die temperature and the regulator will go into thermal shutdown mode.

ELECTRICAL SPECIFICATIONS

Specifications with standard type are for an Operating Junction Temperature of T_J = 25°C only; limits applying over the full Operating Junction Temperature range are denoted by a "•". Minimum and Maximum limits are guaranteed through test, design, or statistical correlation. Typical values represent the most likely parametric norm at T_J = 25°C, and are provided for reference purposes only. Unless otherwise indicated, V_{IN} = (V_{OUT} + 0.5V) to 6V, C_{IN} = 2.2µF, C_{OUT} = 2.2µF and I_{OUT} = 100µA, T_J = -40°C to 85°C.

Parameter	Min.	Typ.	Max.	Units	Conditions
Input Voltage			6	V	•
Output Voltage	-2		+2	%	• Variation from specified V _{OUT}
Output Voltage Temperature Coefficient ²		50		ppm/°C	Δ V _{OUT} /Δ T
Reference Voltage	1.225	1.25	1.275	V	• Adjustable version only
Line Regulation		0.04	0.3	%/V	Δ V _{OUT} (V _{IN} below 6V)
Load Regulation ³		0.07 0.13	0.3 0.5	%	I _{OUT} = 0.1mA to 300mA (SP6203) I _{OUT} = 0.1mA to 500mA (SP6205)
Dropout Voltage for V _{OUT} ≥ 3.0V ⁴		0.06 60 120 180 300	300 500	mV	I _{OUT} = 0.1mA I _{OUT} = 100mA I _{OUT} = 200mA • I _{OUT} = 300mA (SP6203) • I _{OUT} = 500mA (SP6205)
Ground Pin Current ⁵		45 110 175 235 350	100 330 490	µA	• I _{OUT} = 0.1mA (I _{QUIESCENT}) I _{OUT} = 100mA I _{OUT} = 200mA • I _{OUT} = 300mA (SP6203) • I _{OUT} = 500mA (SP6205)
Shutdown Supply Current		0.01	1	µA	• V _{EN} < 0.4V (shutdown)
Current Limit	0.33 0.55	0.50 0.85	0.8 1.4	A	V _{OUT} = 0V (SP6203) V _{OUT} = 0V (SP6205)
Thermal Shutdown Junction Temperature		170		°C	Regulator Turns off
Thermal Shutdown Hysteresis		12		°C	Regulator turns on again at 158°C
Power Supply Rejection Ratio		67		dB	f ≤ 1kHz
Output Noise Voltage ⁶		150 630 12 50	75	µV _{RMS}	C _{BYP} = 10nF, I _{OUT} = 0.1mA C _{BYP} = 10nF, I _{OUT} = 300mA C _{BYP} = 10nF, I _{OUT} = 0.1mA C _{BYP} = 10nF, I _{OUT} = 300mA
Thermal Regulation ⁷		0.05		%/W	Δ V _{OUT} /Δ P _D
Wake-Up Time (T _{WU}) ⁸ (from shutdown mode)		25	50	µS	V _{IN} ≥ 4V ¹⁰ I _{OUT} = 30mA

Parameter	Min.	Typ.	Max.	Units	Conditions
Turn-On Time (T_{ON}) ⁹ (from shutdown mode)		60	120	μ S	$V_{IN} \geq 4V$ ¹⁰ $I_{OUT} = 30mA$
Turn-Off Time (T_{OFF})		100 15	250 25	μ S	$I_{OUT} = 0.1mA, V_{IN} \geq 4V$ ¹⁰ $I_{OUT} = 300mA, V_{IN} \geq 4V$ ¹⁰
Output Discharge Resistance		30		Ω	No Load
Enable Input Logic Low Voltage			0.4	V	• Regulator Shutdown
Enable Input Logic High Voltage	1.6			V	• Regulator Enabled

Note 2: Output voltage temperature coefficient is defined as the worst case voltage change divided by the total temperature range.

Note 3: Regulation is measured at constant junction temperature using low duty cycle pulse testing. Changes in output voltage due to heating effects are covered by the thermal regulation specification.

Note 4: Dropout-voltage is defined as the input to output differential at which the output voltage drops 2% below its nominal value measured at 1V differential.

Note 5: Ground pin current is the regulator quiescent current. The total current drawn from the supply is the sum of the load current plus the ground pin current.

Note 6: Output noise voltage is defined within a certain bandwidth, namely $10Hz < BW < 100kHz$. An external bypass cap (10nF) from reference output (BYP pin) to ground significantly reduces noise at output.

Note 7: Thermal regulation is defined as the change in output voltage at a time "t" after a change in power dissipation is applied, excluding load and line regulation effects. Specifications are for a 300mA load pulse at $V_{IN} = 6V$ for $t = 1ms$.

Note 8: The wake-up time (T_{WU}) is defined as the time it takes for the output to start rising after enable is brought high.

Note 9: The total turn-on time is called the settling time (T_s), which is defined as the condition when both the output and the bypass node are within 2% of their fully enabled values when released from shutdown.

Note 10: For output voltage versions requiring V_{IN} to be lower than 4V, timing (T_{ON} & T_{OFF}) increases slightly.

BLOCK DIAGRAM

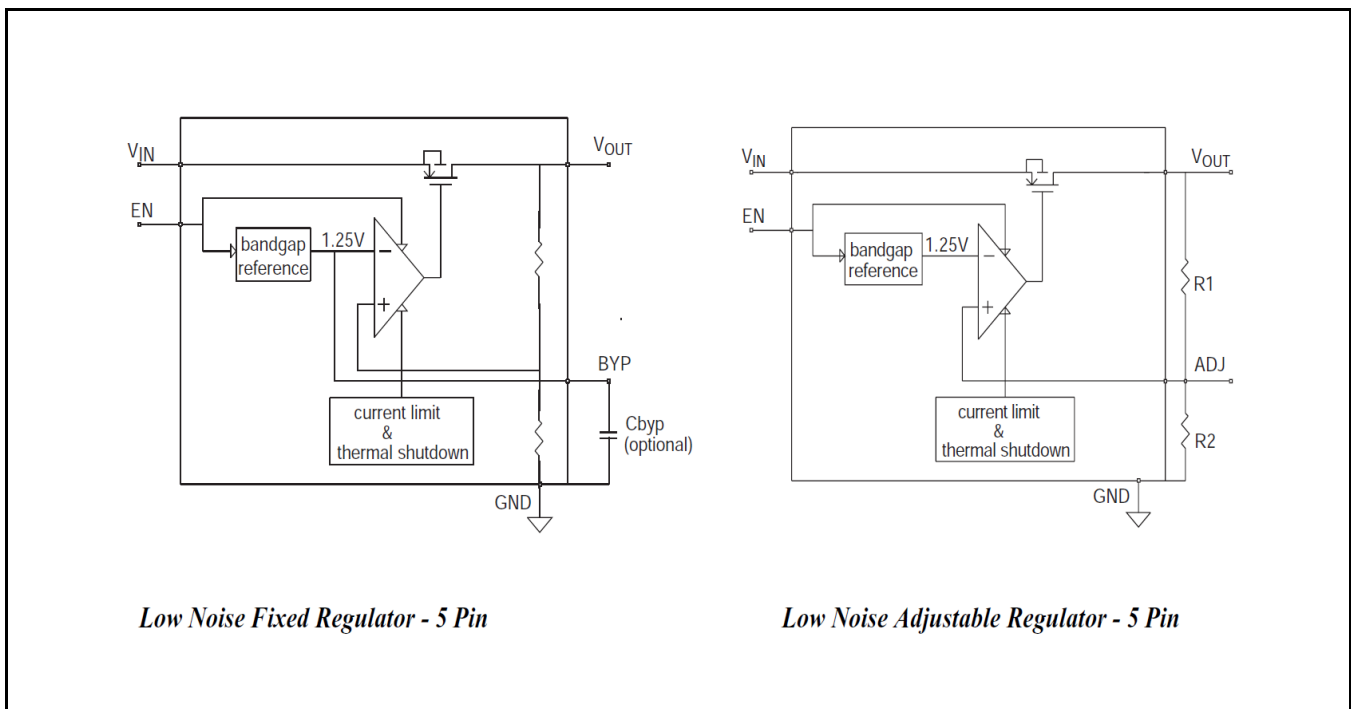

Fig. 2: SP6203/SP6205 Functional Diagram

PIN ASSIGNMENT

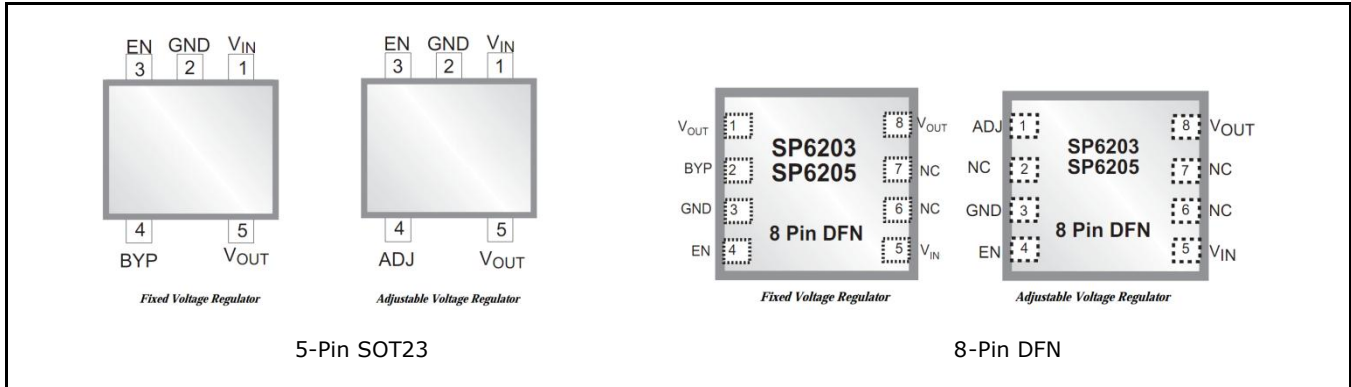

Fig. 3: SP6203/SP6205 Pin Assignment

PIN DESCRIPTION

Name	SOT-23-5	Description
V_{IN}	1	Power Supply Input
GND	2	Ground Terminal
EN	3	Enable/Shutdown - Logic high = enable - Logic low = shutdown
BYP/ADJ	4	Bypass - Fixed voltage option: Reference bypass input for ultra-quiet operation. Connecting a 10nF cap on this pin reduces output noise. Adjustable Input – Adjustable voltage option: Adjustable regulator feedback input. Connect to a resistive voltage-Divider network.
V_{OUT}	5	Regulator Output Voltage

Name	DFN-8	Description
V_{OUT}/ADJ	1	Regulator Output Voltage - Fixed voltage option: Connect to Pin 8 V_{OUT} . Adjustable Input – Adjustable voltage option: Adjustable regulator feedback input. Connect to a resistive voltage-Divider network.
BYP/NC	2	Bypass - Fixed voltage option: Reference bypass input for ultra-quiet operation. Connecting a 10nF cap on this pin reduces output noise. No Connect – Adjustable voltage option.
GND	3	Ground Terminal
EN	4	Enable/Shutdown - Logic high = enable - Logic low = shutdown
V_{IN}	5	Power Supply Input
NC	6	No Connect
NC	7	No Connect
V_{OUT}	8	Regulator Output Voltage



SP6203 / SP6205

300mA/500mA Low Noise CMOS LDO Regulators

ORDERING INFORMATION

Part Number	Ambient Temperature Range	Marking	Package	Packing Quantity	Voltage Option	Note 1
SP6203EM5-L	-40°C ≤ T _A ≤ +125°C	Q2WW	SOT-23-5	Bulk	ADJ	Halogen Free
SP6203EM5-L/TR				2.5K/Tape & Reel		
SP6203EM5-L-2-5		L2WW		Bulk	2.5V	Halogen Free
SP6203EM5-L-2-5/TR				2.5K/Tape & Reel		
SP6203EM5-L-2-8		Q3WW		Bulk	2.8V	Halogen Free
SP6203EM5-L-2-8/TR				2.5K/Tape & Reel		
SP6203EM5L-2-85		H2WW		Bulk	2.85V	Halogen Free
SP6203EM5L-2-85/TR				2.5K/Tape & Reel		
SP6203EM5-L-3-0		M2WW		Bulk	3.0V	Halogen Free
SP6203EM5-L-3-0/TR				2.5K/Tape & Reel		
SP6203EM5-L-3-3		J2WW		Bulk	3.3V	Halogen Free
SP6203EM5-L-3-3/TR				2.5K/Tape & Reel		
SP6203ER-L	-40°C ≤ T _A ≤ +125°C	D0	DFN8	Bulk	ADJ	Halogen Free
SP6203ER-L/TR		YWW XXX		3K/Tape & Reel		
SP6203ER-L-1-8		E0		Bulk	1.8V	Halogen Free
SP6203ER-L-1-8		YWW XXX		3K/Tape & Reel		
SP6205EM5-L	-40°C ≤ T _A ≤ +125°C	A3WW	SOT-23-5	Bulk	ADJ	Halogen Free
SP6205EM5-L/TR				2.5K/Tape & Reel		
SP6205EM5-L-1-8		X2WW		Bulk	1.8V	Halogen Free
SP6205EM5-L-1-8/TR				2.5K/Tape & Reel		
SP6205EM5-L-2-5		V2WW		Bulk	2.5V	Halogen Free
SP6205EM5-L-2-5/TR				2.5K/Tape & Reel		
SP6205EM5-L-2-8		E3WW		Bulk	2.8V	Halogen Free
SP6205EM5-L-2-8/TR				2.5K/Tape & Reel		
SP6205EM5-L-2-85		S2WW		Bulk	2.85V	Halogen Free
SP6205EM5-L-2-85/TR				2.5K/Tape & Reel		
SP6205EM5-L-3-0		W2WW		Bulk	3.0V	Halogen Free
SP6205EM5-L-3-0/TR				2.5K/Tape & Reel		
SP6205EM5-L-3-3		T2WW		Bulk	3.3V	Halogen Free
SP6205EM5-L-3-3/TR				2.5K/Tape & Reel		
SP6205ER-L	-40°C ≤ T _A ≤ +125°C	F0	DFN8	Bulk	ADJ	Halogen Free
SP6205ER-L/TR		YWW XXX		3K/Tape & Reel		
SP6205ER-L-2-5		G0		Bulk	2.5V	Halogen Free
SP6205ER-L-2-5/TR				YWW XXX		

"Y" = Year - "WW" = Work Week - "X" = Lot Number; when applicable.

TYPICAL PERFORMANCE CHARACTERISTICS

All data taken at $V_{IN} = 2.7V$ to $5.5V$, $T_J = T_A = 25^\circ C$, unless otherwise specified - Schematic and BOM from Application Information section of this datasheet.

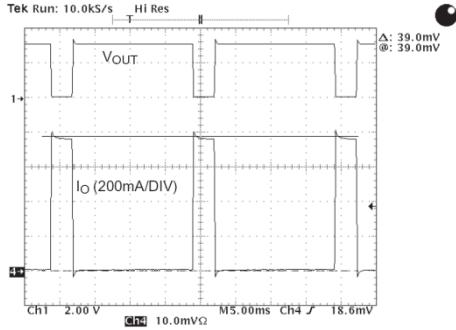

Fig. 4: Current Limit

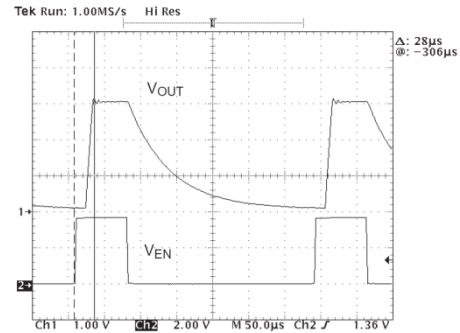

Fig. 5: Turn-On Time, $R_{LOAD}=50\Omega$ (60mA)

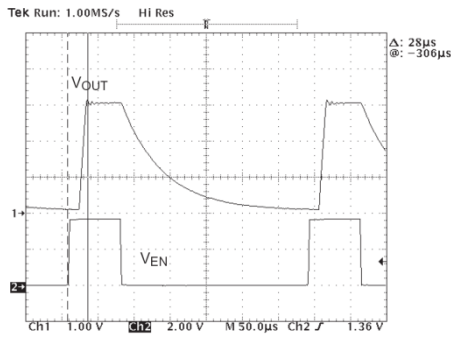

Fig. 6: Turn-Off Time, $R_{LOAD}=6\Omega$ (500mA)

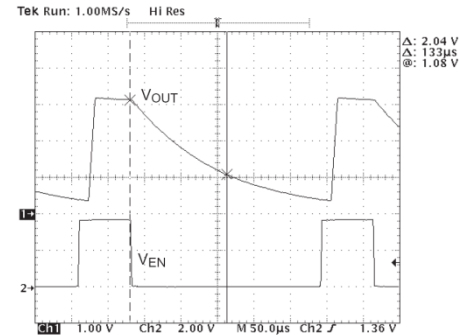

Fig. 7: Turn-Off Time, $R_{LOAD}=30K\Omega$ (0.1mA)

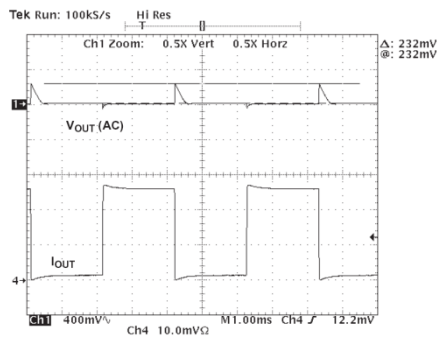

Fig. 8: Load Regulation, $I_O=100\mu A \sim 500mA$

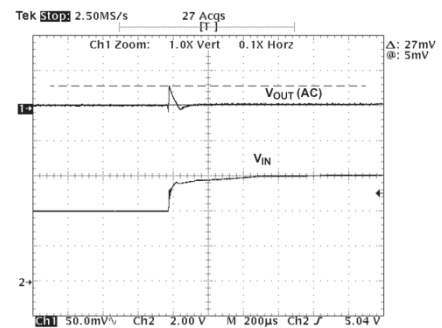

Fig. 9: Regulation, Line Step from 4V to 6V, $I_O=1mA$

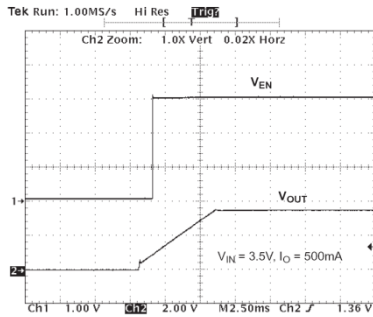

Fig. 10: Start Up Waveform, $V_{IN}=3.5V$, $I_O=500mA$

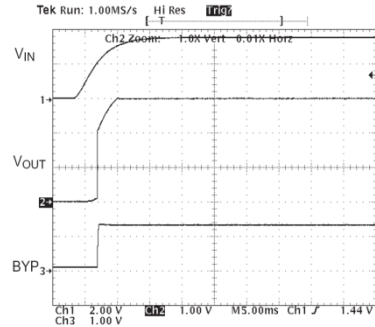

Fig. 11: Start Up Waveform, Slow V_{IN} , No Load

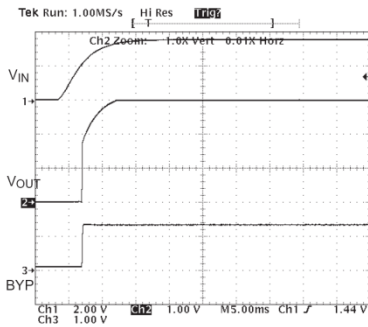

Fig. 12: Start Up Waveform, Slow V_{IN} , 500mA Output Load

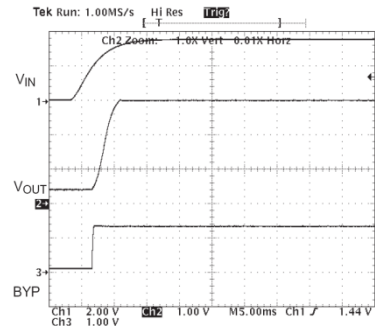

Fig. 13: Start Up Waveform, Slow V_{IN} , $C_{OUT}=1000\mu F$, $I_O=0mA$

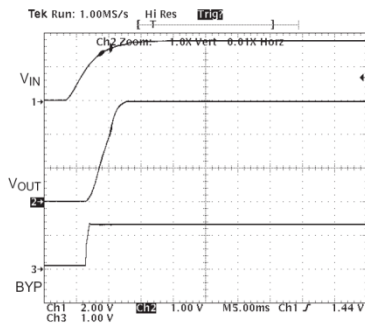

Fig. 14: Start Up Waveform, Slow V_{IN} ,
 $C_{OUT}=1000\mu F$, $I_O=500mA$

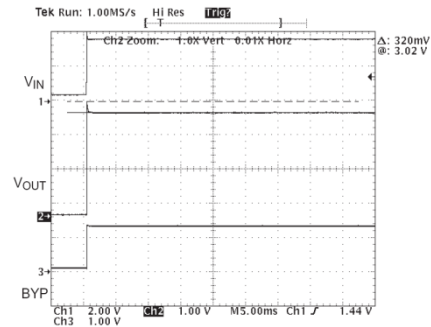

Fig. 15: Fast V_{IN} , No Load

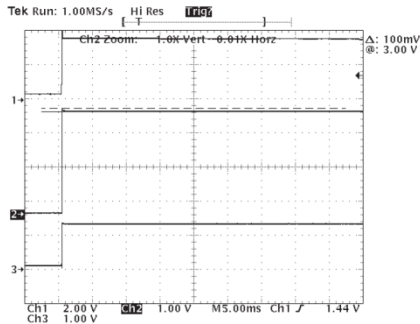

Fig. 16: Fast V_{IN} , 500mA Output Load

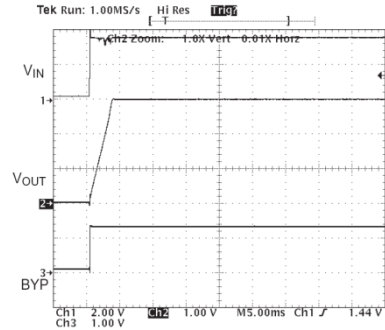

Fig. 17: Fast V_{IN} = 1000 μ F Output Load

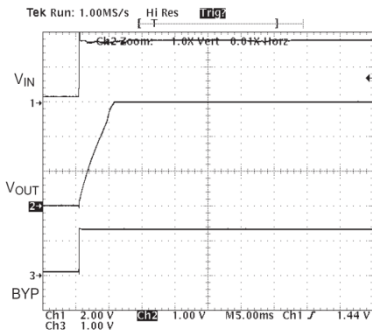

Fig. 18: Fast V_{IN} , C_{OUT} =1000 μ F, I_O =500mA

Output Noise (μ Vrms), $C_{byp} = 10$ nF

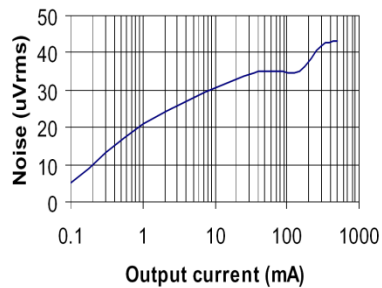

Fig. 19: Output Noise, $C_{BYP} = 10$ nF

Output Noise (μ Vrms), $C_{byp} = \text{open}$

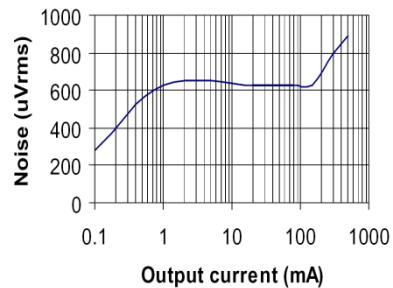

Fig. 20: Output Noise, $C_{BYP} = \text{open}$



THEORY OF OPERATION

GENERAL OVERVIEW

The SP6203/6205 is intended for applications where very low dropout voltage, low supply current and low output noise are critical, even with high load conditions (500mA maximum). Unlike bipolar regulators, the SP6203/6205 (CMOS LDO) supply current increases only slightly with load current.

The SP6203/6205 contains an internal bandgap reference which is fed into the inverting input of the LDO-amplifier. The output voltage is then set by means of a resistor divider and compared to the bandgap reference voltage. The error LDO-amplifier drives the gate of a P-channel MOSFET pass device that has a $R_{DS(ON)}$ of 0.6Ω at 500mA producing a 300mV drop at the output.

Furthermore, the SP6203/6205 has its own current limit circuitry (500mA/850mA) to ensure that the output current will not damage the device during output short, overload or start-up.

Also, the SP6203/6205 includes thermal shutdown circuitry to turn off the device when the junction temperature exceeds 170°C and it remains off until the temperature drops by 12°C .

ENABLE/SHUTDOWN OPERATION

The SP6203/6205 is turned off by pulling the V_{EN} pin below 0.4V and turned on by pulling it above 1.6V.

If this enable/shutdown feature is not required, it should be tied directly to the input supply voltage to keep the regulator output on at all time.

While in shutdown, V_{OUT} quickly falls to zero (turn-off time is dependent on load conditions and output capacitance on V_{OUT}) and power consumption drops nearly to zero.

INPUT CAPACITOR

A small capacitor of $2.2\mu\text{F}$ is required from V_{IN} to GND if a battery is used as the power source. Any good quality electrolytic, ceramic or tantalum capacitor may be used at the input.

OUTPUT CAPACITOR

An output capacitor is required between V_{OUT} and GND to prevent oscillation. A $2.2\mu\text{F}$ output capacitor is recommended.

Larger values make the chip more stable which means an improvement of the regulator's transient response. Also, when operating from other sources than batteries, supply-noise rejection can be improved by increasing the value of the input and output capacitors and using passive filtering techniques.

For a lower output current, a smaller output capacitance can be chosen.

Finally, the output capacitor should have an effective series resistance (ESR) of 0.5Ω or less.

Therefore, the use of good quality ceramic or tantalum capacitors is advised.

BYPASS CAPACITOR

A bypass pin (BYP) is provided to decouple the bandgap reference. A 10nF external capacitor connected from BYP to GND reduces noise present on the internal reference, which in turn significantly reduces output noise and also improves power supply rejection. Note that the minimum value of C_{OUT} must be increased to maintain stability when the bypass capacitor is used because C_{BYP} reduces the regulator phase margin. If output noise is not a concern, this input may be left unconnected. Larger capacitor values may be used to further improve power supply rejection, but result in a longer time period (slower turn on) to settle output voltage when power is initially applied.

NO LOAD STABILITY

The SP6203/6205 will remain stable and in regulation with no external load (other than the internal voltage driver) unlike many other voltage regulators. This is especially important in CMOS RAM battery back-up applications.

TURN ON TIME

The turn on response is split up in two separate response categories: the wake up

time (T_{WU}) and the settling time (T_S). The wake up time is defined as the time it takes for the output to rise to 2% of its total value after being released from shutdown ($E_N > 0.4V$). The settling time is defined as the condition where the output reaches 98% of its total value after being released from shutdown. The latter is also called the turn on time and is dependent on the output capacitor, a little bit on load and, if present, on a bypass capacitor.

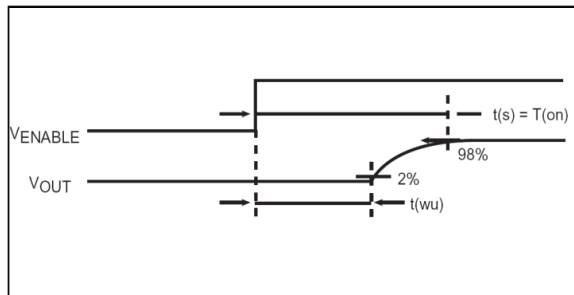

TURN OFF TIME

The turn off time is defined as the condition where the output voltage drops about 66% (θ) of its total value. 5θ to 7θ is the constant where the output voltage drops nearly to zero. There will always be a small voltage drop in shutdown because of the switch unless we short-circuit it. The turn off time of the output voltage is dependent on load conditions, output capacitance on V_{OUT} (time constant $\tau = R_{LC_L}$) and also on the difference in voltage between input and output.

THERMAL CONSIDERATIONS

The SP6203/6205 is designed to provide 300/500mA of continuous current in a tiny package. Maximum power dissipation can be calculated based on the output current and the voltage drop across the part. To determine the maximum power dissipation of the package, use the junction-to-ambient thermal resistance of the device and the following basic equation:

$$P_D = (T_{J(max)} - T_A) / \theta_{JA}$$

$T_{J(max)}$ is the maximum junction temperature of the die and is 125°C. T_A is the ambient temperature. θ_{JA} is the junction-to-ambient thermal resistance of the regulator and is layout dependent. The SOT-23-5 package has

a θ_{JA} of approximately 191°C/W for minimum PCB copper footprint area.

This results in a maximum power dissipation of:

$$P_{D(max)} = [(125^\circ C - 25^\circ C) / (191^\circ C/W)] = 523mW$$

The actual power dissipation of the regulator circuit can be determined using one simple equation:

$$P_D = (V_{IN} - V_{OUT}) * I_{OUT} + V_{IN} * I_{GND}$$

To prevent the device from entering thermal shutdown, maximum power dissipation cannot be exceeded.

Substituting $P_{D(max)}$ for P_D and solving for the operating conditions that are critical to the application will give the maximum operating conditions for the regulator circuit. For example, if we are operating the SP6203 3.0V at room temperature, with a minimum footprint layout and output current of 300mA, the maximum input voltage can be determined, based on the equation below. Ground pin current can be taken from the electrical specifications table (0.23mA at 300mA).

$$390mW = (V_{IN} - 3.0V) * 300mA + V_{IN} * 0.23mA$$

After calculations, we find that the maximum input voltage of a 3.0V application at 300mA of output current in a SOT-23-5 package is 4.7V.

So if the intent is to operate a 5V output version from a 6V supply at 300mA load and at a 25°C ambient temperature, then the actual total power dissipation will be:

$$P_D = [(6V - 5V) * [300mA]] + (6V * 0.23mA) = 301.4mW$$

This is well below the 523mW package maximum. Therefore, the regulator can be used.

Note that the regulator cannot always be used at its maximum current rating. For example, in a 5V input to 3.0V output application at an ambient temperature of 25°C and operating at the full 500mA ($I_{GND} = 0.355mA$) load, the regulator is limited to a much lower load current, determined by the following equation:

$$523mW = ([5V - 3V] * [I_{load(max)}]) + (5V * 0.350mA)$$



After calculation, we find that in such an application (SP6205) the regulator is limited to 260.6mA. Doing the same calculations for the 300mA LDO (SP6203) will limit the regulator's output current to 260.9mA.

Also, taking advantage of the very low dropout voltage characteristics of the SP6203/6205, power dissipation can be reduced by using the lowest possible input voltage to minimize the input-to-output drop.

ADJUSTABLE REGULATOR APPLICATIONS

The SP6203/6205 can be adjusted to a specific output voltage by using two external resistors (see functional diagram). The resistors set the output voltage based on the following equation:

$$V_{OUT} = V_{REF} * (R1/R2 + 1)$$

Resistor values are not critical because ADJ (adjust) has a high input impedance, but for best performance use resistors of 470KΩ or less. A bypass capacitor from ADJ to V_{OUT} provides improved noise performance.

DUAL-SUPPLY OPERATION

When used in dual supply systems where the regulator load is returned to a negative supply, the output voltage must be diode clamped to ground.

LAYOUT CONSIDERATIONS

The primary path of heat conduction out of the package is via the package leads. Therefore, careful considerations have to be taken into account:

- 1) Attaching the part to a larger copper footprint will enable better heat transfer from the device, especially on PCB's where there are internal ground and power planes.
- 2) Place the input, output and bypass capacitors close to the device for optimal transient response and device behavior.
- 3) Connect all ground connections directly to the ground plane. In case there's no ground plane, connect to a common local ground point before connecting to board ground.

Such layouts will provide a much better thermal conductivity (lower θ_{JA}) for, a higher maximum allowable power dissipation limit.

PACKAGE SPECIFICATION

8-PIN DFN

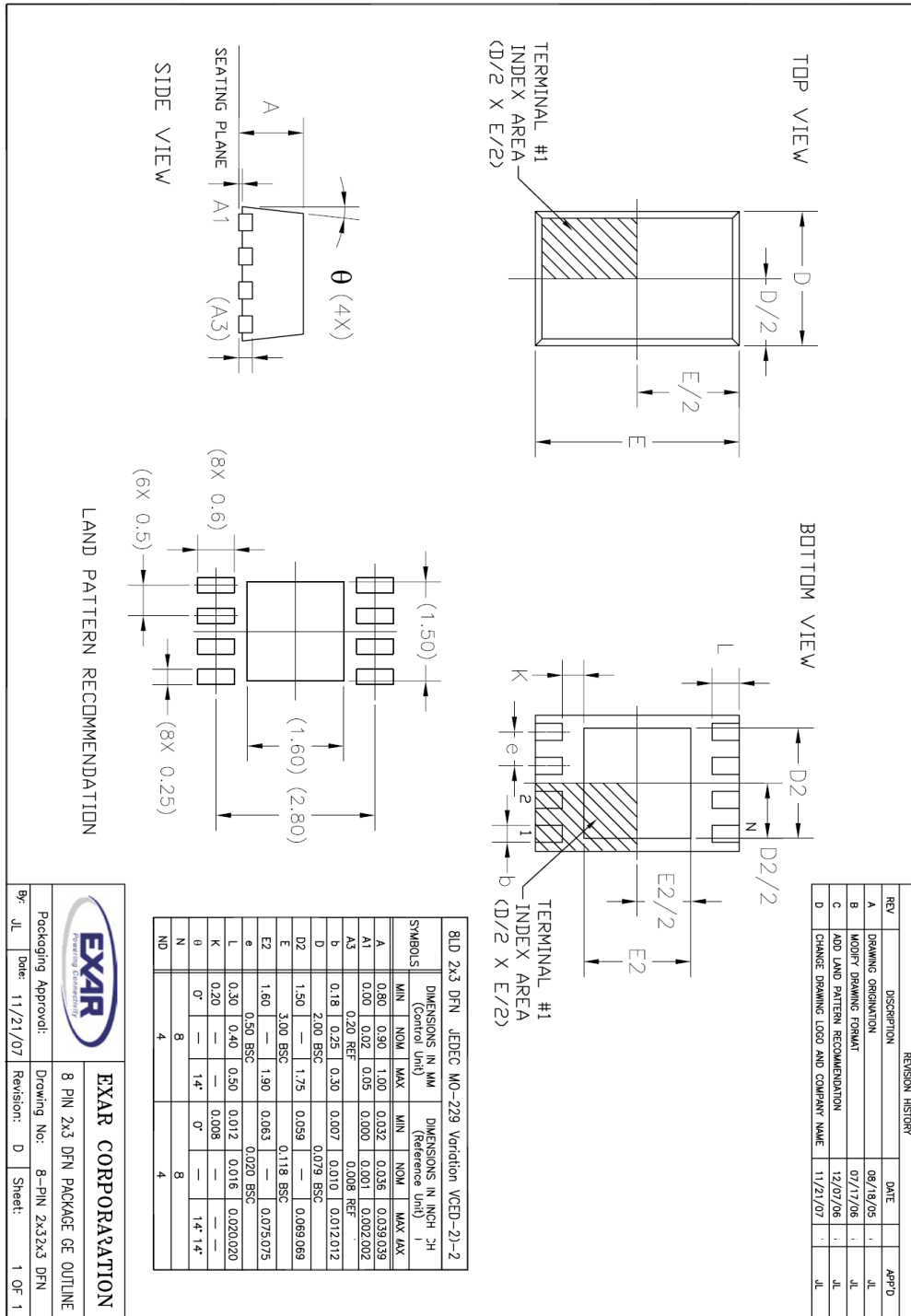

5-PIN SOT-23

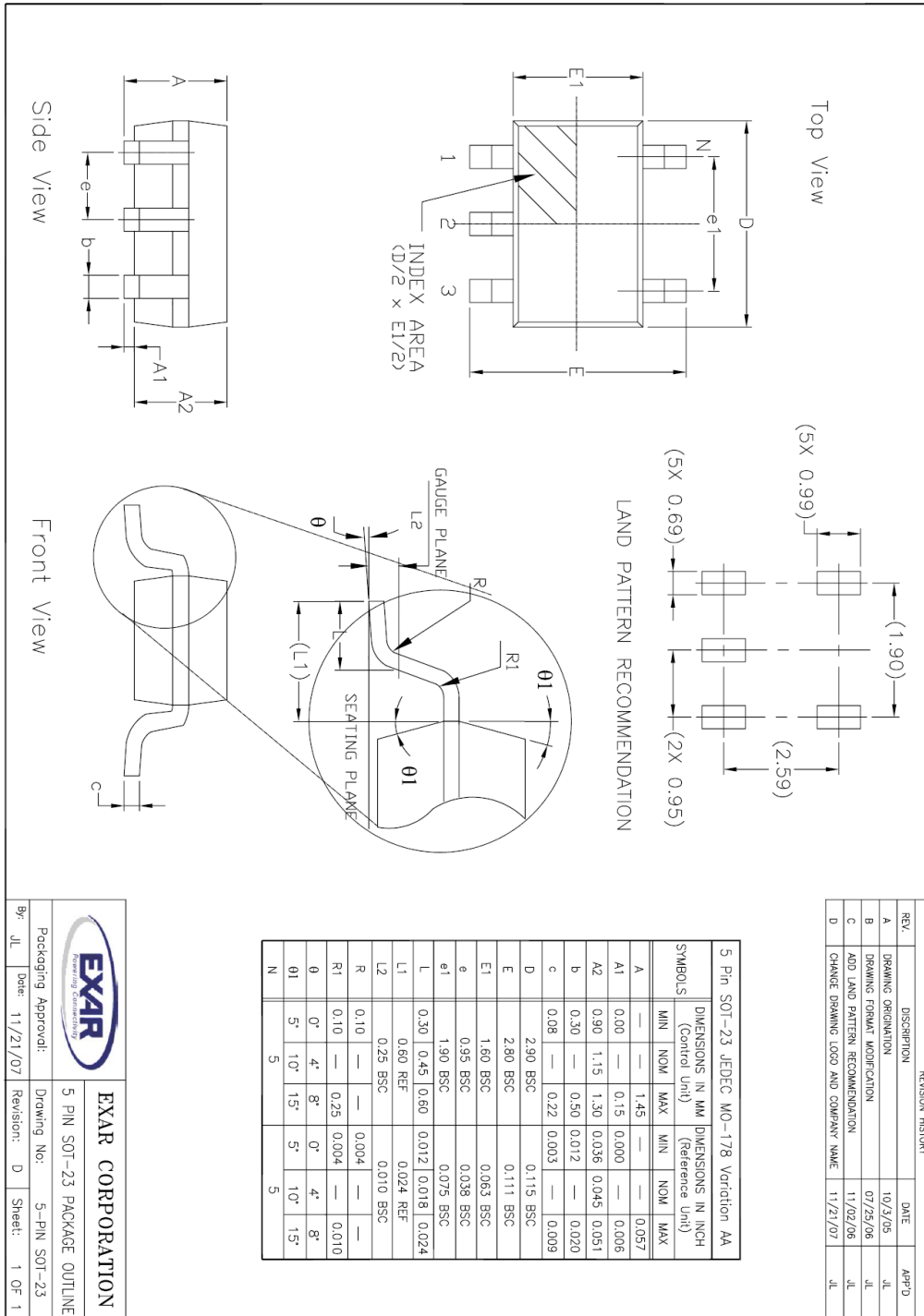

REVISION HISTORY		
REV	DESCRIPTION	DATE
A	DRAWING ORIGINATOR	10/23/05
B	DRAWING FORMAT MODIFICATION	07/25/06
C	ADD LAND PATTERN RECOMMENDATION	11/02/06
D	CHANGE DRAWING LOGO AND COMPANY NAME	11/23/07

		EXAR CORPORATION	
Packaging Approval:		Drawing No.: 5-PIN SOT-23 PACKAGE OUTLINE	
By: JL	Date: 11/21/07	Revision: D	Sheet: 1 OF 1



SP6203 / SP6205

300mA/500mA Low Noise CMOS LDO Regulators

REVISION HISTORY

Revision	Date	Description
2.0.0	04/03/2012	Reformatted Data Sheet Includes top package marking update.

FOR FURTHER ASSISTANCE

Email: customersupport@exar.com
Exar Technical Documentation: <http://www.exar.com/TechDoc/default.aspx?>

EXAR CORPORATION

HEADQUARTERS AND SALES OFFICES

48720 Kato Road
Fremont, CA 94538 – USA
Tel.: +1 (510) 668-7000
Fax: +1 (510) 668-7030
www.exar.com



NOTICE

EXAR Corporation reserves the right to make changes to the products contained in this publication in order to improve design, performance or reliability. EXAR Corporation assumes no responsibility for the use of any circuits described herein, conveys no license under any patent or other right, and makes no representation that the circuits are free of patent infringement. Charts and schedules contained here in are only for illustration purposes and may vary depending upon a user's specific application. While the information in this publication has been carefully checked; no responsibility, however, is assumed for inaccuracies.

EXAR Corporation does not recommend the use of any of its products in life support applications where the failure or malfunction of the product can reasonably be expected to cause failure of the life support system or to significantly affect its safety or effectiveness. Products are not authorized for use in such applications unless EXAR Corporation receives, in writing, assurances to its satisfaction that: (a) the risk of injury or damage has been minimized; (b) the user assumes all such risks; (c) potential liability of EXAR Corporation is adequately protected under the circumstances.

Reproduction, in part or whole, without the prior written consent of EXAR Corporation is prohibited.