



GENERAL DESCRIPTION

The SPX3819 is a positive voltage regulator with a low dropout voltage and low noise output. In addition, this device offers a very low ground current of 800 μ A at 100mA output. The SPX3819 has an initial tolerance of less than 1% max and a logic compatible ON/OFF switched input. When disabled, power consumption drops to nearly zero. Other key features include reverse battery protection, current limit, and thermal shutdown. The SPX3819 includes a reference bypass pin for optimal low noise output performance. With its very low output temperature coefficient, this device also makes a superior low power voltage reference.

The SPX3819 is an excellent choice for use in battery-powered applications such as cordless telephones, radio control systems, and portable computers. It is available in several fixed output voltage options or with an adjustable output voltage.

This device is offered in 8 pin NSOIC, 8 pin DFN and 5-pin SOT-23 packages.

APPLICATIONS

- **Portable Consumer Equipment**
- **Portable Instrumentation**
- **Industrial Equipment**
- **SMPS Post Regulators**

FEATURES

- **Low Noise: 40 μ V Possible**
- **High Accuracy: 1%**
- **Reverse Battery Protection**
- **Low Dropout: 340mV at Full Load**
- **Low Quiescent Current: 90 μ A**
- **Zero Off-Mode Current**
- **Fixed & Adjustable Output Voltages:**
 - 1.2V, 1.5V, 1.8V, 2.5V, 3.0V, 3.3V & 5.0V Fixed Output Voltages
 - ≥ 1.235 V Adjustable Output Voltages
- **Available in RoHS Compliant, Lead Free Packages:**
 - 5-pin SOT-23, 8-pin SOIC and 8-pin DFN

TYPICAL APPLICATION DIAGRAM

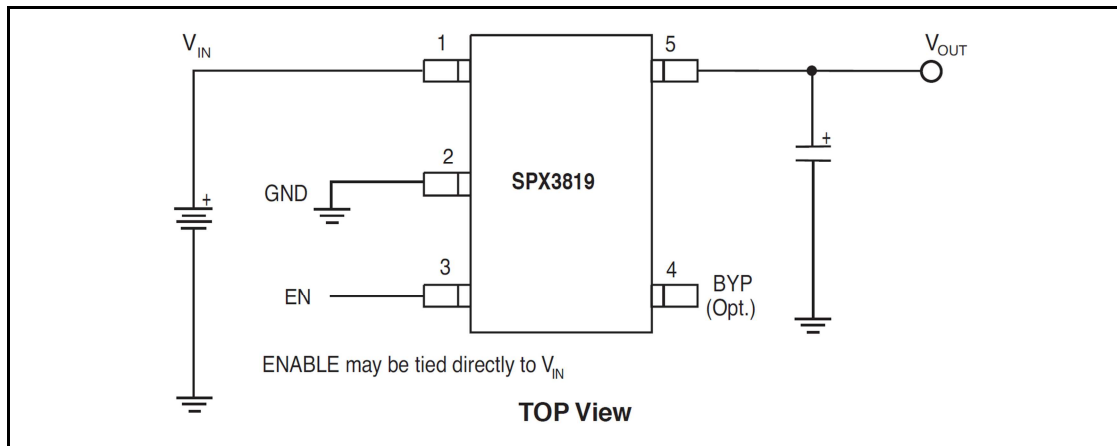

Fig. 1: SPX3819 Application Circuit



A New Direction in Mixed-Signal

SPX3819

500mA Low-Noise LDO Voltage Regulator

ABSOLUTE MAXIMUM RATINGS

These are stress ratings only and functional operation of the device at these ratings or any other above those indicated in the operation sections of the specifications below is not implied. Exposure to absolute maximum rating conditions for extended periods of time may affect reliability.

V_{IN} , EN -20V to +20V
 Storage Temperature -65°C to 150°C
 Junction Temperature 150°C
 Power Dissipation Internally Limited
 Lead Temperature (Soldering, 5 sec) 260°C
 ESD Rating (HBM - Human Body Model) 2kV

OPERATING RATINGS

Input Voltage Range V_{IN} 2.5V to 16V
 Enable Pin EN 0.0V to V_{IN}
 Junction Temperature Range -40°C to +125°C
 Thermal Resistance¹
 θ_{JA} (SOT23-5) 191°C/W
 θ_{JA} (NSOIC-8) 128.4°C/W
 θ_{JA} (DFN-8) 59°C/W

Note 1: The maximum allowable power dissipation is a function of maximum operating junction temperature, $T_{J(max)}$ the junction to ambient thermal resistance, and the ambient θ_{JA} , and the ambient temperature T_A . The maximum allowable power dissipation at any ambient temperature is given: $P_{D(max)} = (T_{J(max)} - T_A) / \theta_{JA}$, exceeding the maximum allowable power limit will result in excessive die temperature; thus, the regulator will go into thermal shutdown

ELECTRICAL SPECIFICATIONS

Specifications with standard type are for an Operating Junction Temperature of $T_J = 25^\circ\text{C}$ only; limits applying over the full Operating Junction Temperature range are denoted by a “•”. Minimum and Maximum limits are guaranteed through test, design, or statistical correlation. Typical values represent the most likely parametric norm at $T_J = 25^\circ\text{C}$, and are provided for reference purposes only. Unless otherwise indicated, $V_{IN} = V_{OUT} + 1\text{V}$ ($V_{IN} = V_{OUT} + 1.2\text{V}$ for 1.2V option), $I_L = 100\mu\text{A}$, $C_L = 1\mu\text{F}$, $V_{EN} \geq 2.5\text{V}$, $T_A = T_J = 25^\circ\text{C}$.

Parameter	Min.	Typ.	Max.	Units	Conditions
Output Voltage Tolerance	-1		+1	%	•
	-2		+2		
Output Voltage Temperature Coefficient		57		ppm/°C	
Line Regulation		0.04	0.1	%/V	$V_{IN} = V_{OUT} + 1$ to 16V and $V_{EN} \leq 6\text{V}$
			0.2		• $V_{IN} = V_{EN} = V_{OUT} + 1 \leq 8\text{V}$
			0.2		$V_{IN} = V_{EN} = V_{OUT} + 1 \leq 16\text{V}$ $T_A = 25^\circ\text{C}$ to 85°C
Load Regulation		0.05	0.4	%	$I_L = 0.1\text{mA}$ to 500mA
Dropout Voltage ($V_{IN} - V_{OUT}$) ²		10	60	mV	• $I_L = 100\mu\text{A}$
		125	175		• $I_L = 50\text{mA}$
		180	250		• $I_L = 150\text{mA}$
		340	350		• $I_L = 500\text{mA}$
			450		
			700		
Quiescent Current (I_{GND})		0.05	3	μA	$V_{ENABLE} \leq 0.4\text{V}$
			8		• $V_{ENABLE} = 0.25\text{V}$
Ground Pin Current (I_{GND})		90	150	μA	• $I_L = 100\mu\text{A}$
			190		• $I_L = 50\text{mA}$
		250	650		
			900	mA	• $I_L = 150\text{mA}$
		1.0	2.0		• $I_L = 500\text{mA}$
			2.5		
		6.5	25.0		
			30.0		
Ripple Rejection (PSRR)		70		dB	



A New Direction in Mixed-Signal

SPX3819

500mA Low-Noise LDO Voltage Regulator

Parameter	Min.	Typ.	Max.	Units	Conditions
Current Limit (I_{LIMIT})		800		mA	$V_{OUT}=0V$
			950		
Output Noise (e_{NO})		300		μV_{RMS}	$I_L = 10mA, C_L = 1.0\mu F, C_{IN} = 1\mu F, (10Hz - 100kHz)$
		40		μV_{RMS}	$I_L = 10mA, C_L = 1.0\mu F, C_{BYP} = 1\mu F, C_{IN} = 1\mu F, (10Hz - 100kHz)$
Input Voltage Level Logic Low (V_{IL})			0.4	V	OFF
Input Voltage Level Logic High (V_{IH})	2			V	ON
ENABLE Input Current		0.01	2	μA	$V_{IL} \leq 0.4V$ $V_{IH} \geq 2.0V$
		3	20		

Note 2: Not applicable to output voltage 2V or less.

PIN ASSIGNMENT

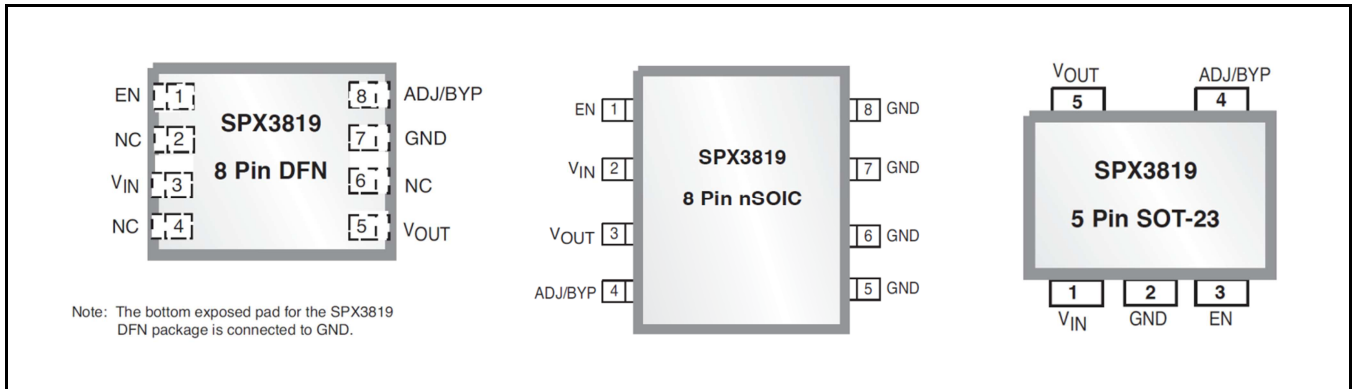

Fig. 2: SPX3819 Pin Assignment

PIN DESCRIPTION

Name	Pin # nSOIC	Pin # DFN	Pin # SOT-23	Description
VIN	2	3	1	Supply Input
GND	5, 6, 7, 8	7	2	Ground
VOUT	3	5	5	Regulator Output
EN	1	1	3	Enable(input). CMOS compatible control input. Logic high – enable; logic low or open = shutdown
ADJ/BYP	4	8	4	Adjust(input). Feedback input. Connect to resistive voltage-divider network
NC	-	2, 4, 6	-	No Connect



A New Direction in Mixed-Signal

SPX3819

500mA Low-Noise LDO Voltage Regulator

ORDERING INFORMATION

Part Number	Temperature Range	Marking	Package	Packing Quantity	Note 1	Note 2
SPX3819M5-L	-40°C ≤ T _J ≤ +125°C	G1WW	SOT-23-5	Bulk	Halogen free	
SPX3819M5-L/TR				2.5K/Tape & Reel		
SPX3819M5-L-1-2	-40°C ≤ T _J ≤ +125°C	A4WW	SOT-23-5	Bulk	Halogen free	
SPX3819M5-L-1-2/TR				2.5K/Tape & Reel		
SPX3819M5-L-1-5	-40°C ≤ T _J ≤ +125°C	W3WW	SOT-23-5	Bulk	Halogen free	
SPX3819M5-L-1-5/TR				2.5K/Tape & Reel		
SPX3819M5-L-1-8	-40°C ≤ T _J ≤ +125°C	G3WW	SOT-23-5	Bulk	Halogen free	
SPX3819M5-L-1-8/TR				2.5K/Tape & Reel		
SPX3819M5-L-2-5	-40°C ≤ T _J ≤ +125°C	H3WW	SOT-23-5	Bulk	Halogen free	
SPX3819M5-L-2-5/TR				2.5K/Tape & Reel		
SPX3819M5-L-3-0	-40°C ≤ T _J ≤ +125°C	J3WW	SOT-23-5	Bulk	Halogen free	
SPX3819M5-L-3-0/TR				2.5K/Tape & Reel		
SPX3819M5-L-3-3	-40°C ≤ T _J ≤ +125°C	L3WW	SOT-23-5	Bulk	Halogen free	
SPX3819M5-L-3-3/TR				2.5K/Tape & Reel		
SPX3819M5-L-5-0	-40°C ≤ T _J ≤ +125°C	M3WW	SOT-23-5	Bulk	Halogen free	
SPX3819M5-L-5-0/TR				2.5K/Tape & Reel		
SPX3819R2-L	-40°C ≤ T _J ≤ +125°C	L0L	DFN-8	Bulk	Halogen free	
SPX3819R2-L/TR		YWW XX		3.0K/Tape & Reel		
SPX3819R2-L-1-2	-40°C ≤ T _J ≤ +125°C	M0L	DFN-8	Bulk	Halogen free	
SPX3819R2-L-1-2/TR		YWW XX		3.0K/Tape & Reel		
SPX3819R2-L-1-8	-40°C ≤ T _J ≤ +125°C	N0L	DFN-8	Bulk	Halogen free	
SPX3819R2-L-1-8/TR		YWW XX		3.0K/Tape & Reel		
SPX3819S-L	-40°C ≤ T _J ≤ +125°C	SPX3819	NSOIC-8	Bulk	Halogen free	
SPX3819S-L/TR		YYWWL XXX		2.5K/Tape & Reel		
SPX3819S-L-1-2	-40°C ≤ T _J ≤ +125°C	SPX3819	NSOIC-8	Bulk	Halogen free	
SPX3819S-L-1-2/TR		12YYWWL XXX		2.5K/Tape & Reel		
SPX3819S-L-1-5	-40°C ≤ T _J ≤ +125°C	SPX3819	NSOIC-8	Bulk	Halogen free	
SPX3819S-L-1-5/TR		15YYWWL XXX		2.5K/Tape & Reel		
SPX3819S-L-1-8	-40°C ≤ T _J ≤ +125°C	SPX3819	NSOIC-8	Bulk	Halogen free	
SPX3819S-L-1-8/TR		18YYWWL XXX		2.5K/Tape & Reel		
SPX3819S-L-2-5	-40°C ≤ T _J ≤ +125°C	SPX3819	NSOIC-8	Bulk	Halogen free	
SPX3819S-L-2-5/TR		25YYWWL XXX		2.5K/Tape & Reel		
SPX3819S-L-3-3	-40°C ≤ T _J ≤ +125°C	SPX3819	NSOIC-8	Bulk	Halogen free	
SPX3819S-L-3-3/TR		33YYWWL XXX		2.5K/Tape & Reel		
SPX3819S-L-5-0	-40°C ≤ T _J ≤ +125°C	SPX3819	NSOIC-8	Bulk	Halogen free	
SPX3819S-L-5-0/TR		50YYWWL XXX		2.5K/Tape & Reel		

“YY” = Year – “WW” = Work Week – “X” = Lot Number; when applicable.

TYPICAL PERFORMANCE CHARACTERISTICS

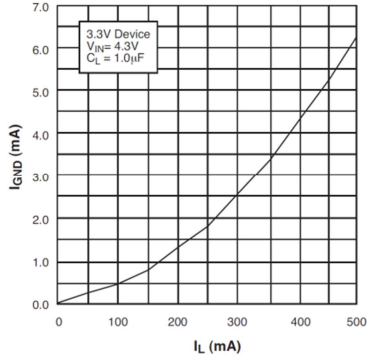

Fig. 3: Ground Current vs Load Current

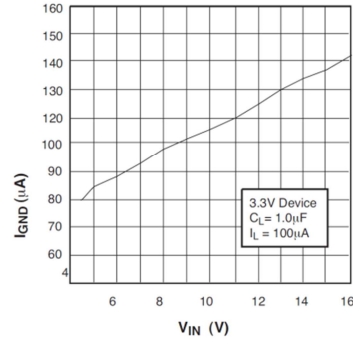

Fig. 4: Ground Current vs Input Voltage

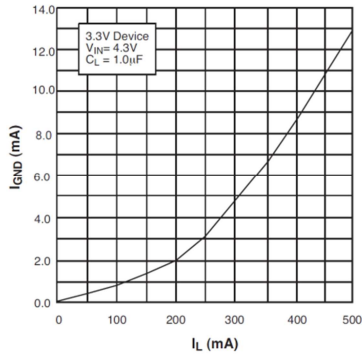

Fig. 5 Ground Current vs Load Current in Dropout

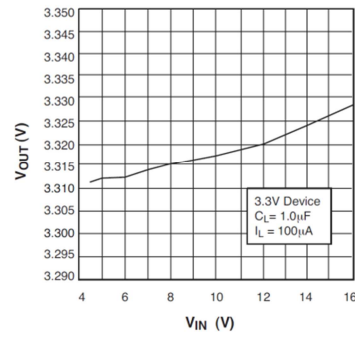

Fig. 6 Output Voltage vs Input Voltage

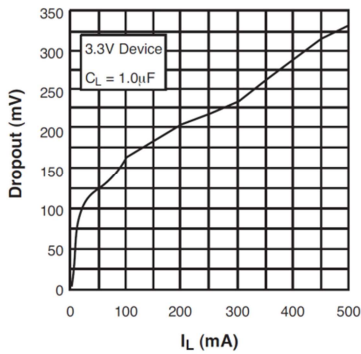

Fig. 7 Dropout Voltage vs Load Current

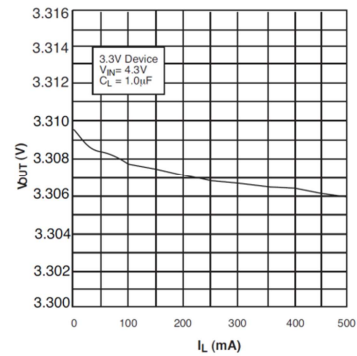

Fig. 8 Output Voltage vs Load Current

500mA Low-Noise LDO Voltage Regulator

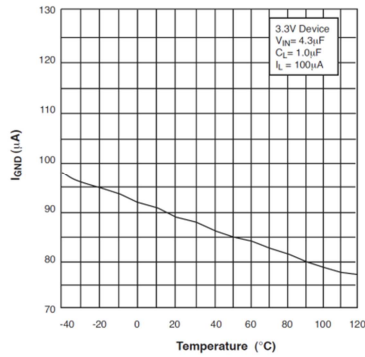

Fig. 9 Ground Current vs Temperature with 100µA Load

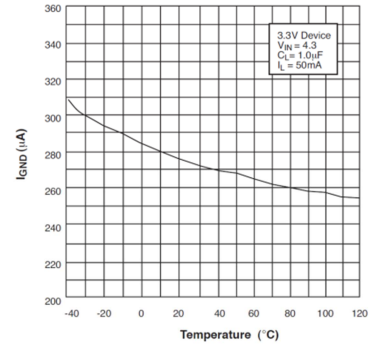

Fig. 10 Ground Current vs Temperature with 50mA Load

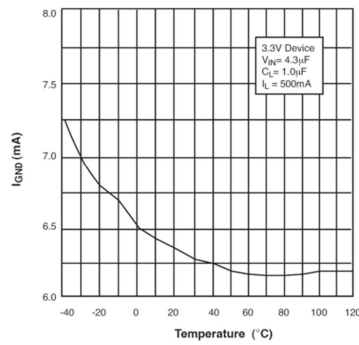

Fig. 11 Ground Current vs Temperature with 500mA Load

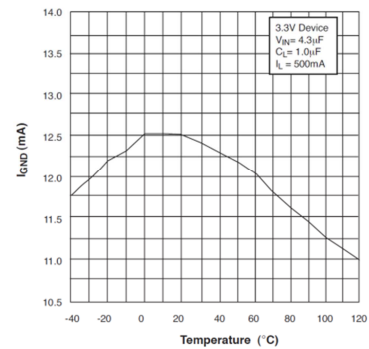

Fig. 12 Ground Current vs Temperature in Dropout

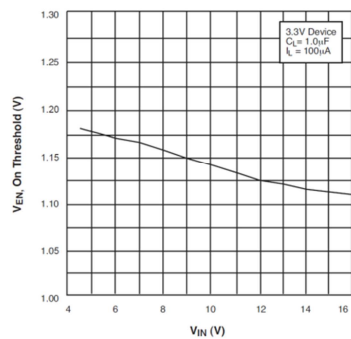

Fig. 13 ENABLE Voltage, ON threshold, vs Input Voltage

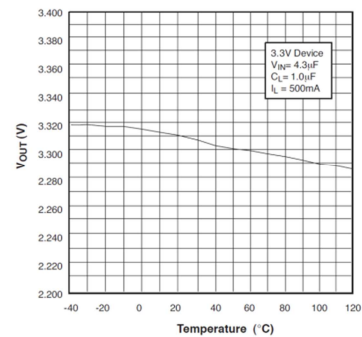

Fig. 14 Output Voltage vs Temperature

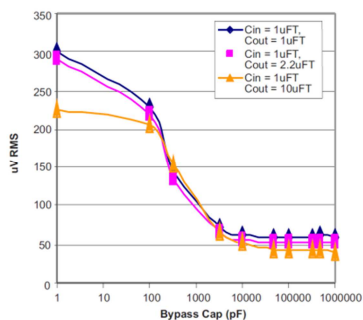

Fig. 15 Output Noise vs Bypass Capacitor Value IL = 10mA, 10Hz - 100kHz

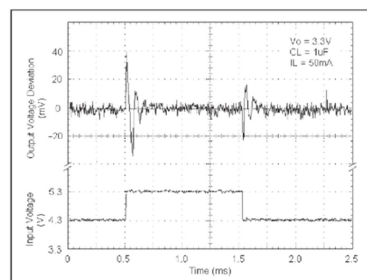

Fig. 16 Line Transient Response for 3.3V Device

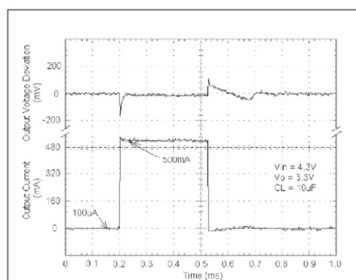

Fig. 17 Load Transient Response for 3.3V Device

APPLICATION INFORMATION

The SPX3819 requires an output capacitor for device stability. Its value depends upon the application circuit. In general, linear regulator stability decreases with higher output currents. In applications where the SPX3819 is sourcing less current, a lower output capacitance may be sufficient. For example, a regulator outputting only 10mA, requires approximately half the capacitance as the same regulator sourcing 150mA.

Bench testing is the best method for determining the proper type and value of the capacitor since the high frequency characteristics of electrolytic capacitors vary widely, depending on type and manufacturer. A high quality 2.2 μ F aluminum electrolytic capacitor works in most application circuits,

but the same stability often can be obtained with a 1 μ F tantalum electrolytic.

With the SPX3819 adjustable version, the minimum value of output capacitance is a function of the output voltage. The value decreases with higher output voltages, since closed loop gain is increased.

TYPICAL APPLICATIONS CIRCUITS

A 10nF capacitor on the BYP pin will significantly reduce output noise, but it may be left unconnected if the output noise is not a major concern. The SPX3819 start-up speed is inversely proportional to the size of the BYP capacitor. Applications requiring a slow rampup of the output voltage should use a larger CBYP. However, if a rapid turn-on is necessary, the BYP capacitor can be omitted.

500mA Low-Noise LDO Voltage Regulator

The SPX3819's internal reference is available through the BYP pin.

Figure 18 represents a SPX3819 standard application circuit. The EN (enable) pin is pulled high (>2.0V) to enable the regulator. To disable the regulator, EN < 0.4V.

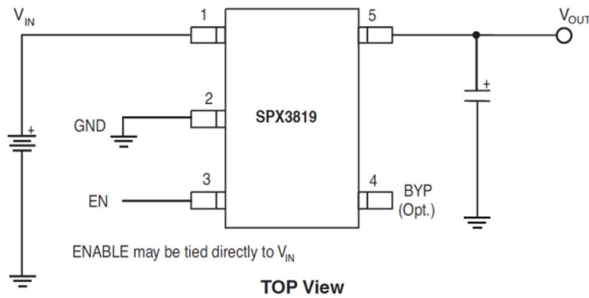

Fig. 18: Standard Application Circuit

The output voltage is calculated using the formula:

$$V_{OUT} = 1.235V \times [1 + R1/R2]$$

R2 must be >10kΩ and for best results, R2 should be between 22kΩ and 47kΩ.

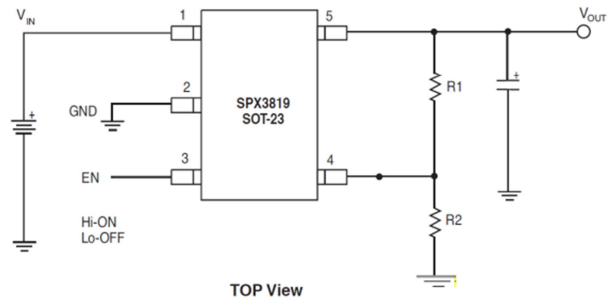

Fig. 19: Typical Adjustable Output Voltage Configuration

The SPX3819 in Figure 19 illustrates a typical adjustable output voltage configuration. Two resistors (R1 and R2) set the output voltage.



A New Direction in Mixed-Signal

SPX3819

500mA Low-Noise LDO Voltage Regulator

PACKAGE SPECIFICATION

8-PIN SOICN

Top View

Side View

Front View

8 Pin SOICN		JEDEC MS-012		Variation AA		
SYMBOLS	DIMENSIONS IN MM (Control Unit)			DIMENSIONS IN INCH (Reference Unit)		
	MIN	NOM	MAX	MIN	NOM	MAX
A	1.35	—	1.75	0.053	—	0.069
A1	0.10	—	0.25	0.004	—	0.010
A2	1.25	—	1.65	0.049	—	0.065
b	0.31	—	0.51	0.012	—	0.020
c	0.17	—	0.25	0.007	—	0.010
E	6.00	BSC	—	0.236	BSC	—
E1	3.90	BSC	—	0.154	BSC	—
e	1.27	BSC	—	0.050	BSC	—
h	0.25	—	0.50	0.010	—	0.020
L	0.40	—	1.27	0.016	—	0.050
L1	1.04	REF	—	0.041	REF	—
L2	0.29	BSC	—	0.010	BSC	—
R	0.07	—	—	0.003	—	—
R1	0.07	—	—	0.003	—	—
θ	0°	—	8°	0°	—	8°
θ1	5°	—	15°	5°	—	15°
θ2	0°	—	—	0°	—	—
D	4.90	BSC	—	0.193	BSC	—
N	8	—	—	8	—	—

REVISION HISTORY			
REV.	DESCRIPTION	DATE	APP'D
A	DRAWING ORIGINATOR	08/16/05	JL
B	DRAWING FORMAT MODIFICATION	07/19/06	JL
C	CHANGE DRAWING LOGO ADN COMPANY NAME	11/16/07	JL

	EXAR CORPORATION
A New Direction in Mixed-Signal	8 PIN SOICN PACKAGE OUTLINE
Packaging Approval:	Drawing No: 8-PIN SOICN
By: JL Date: 11/16/07	Revision: C Sheet: 1 OF 1

	EXAR CORPORATION
A New Direction in Mixed-Signal	8 PIN SOICN PACKAGE OUTLINE
Packaging Approval:	Drawing No: 8-PIN SOICN
By: JL Date: 11/16/07	Revision: C Sheet: 1 OF 1



A New Direction in Mixed-Signal

SPX3819

500mA Low-Noise LDO Voltage Regulator

8-PIN 2x3 DFN

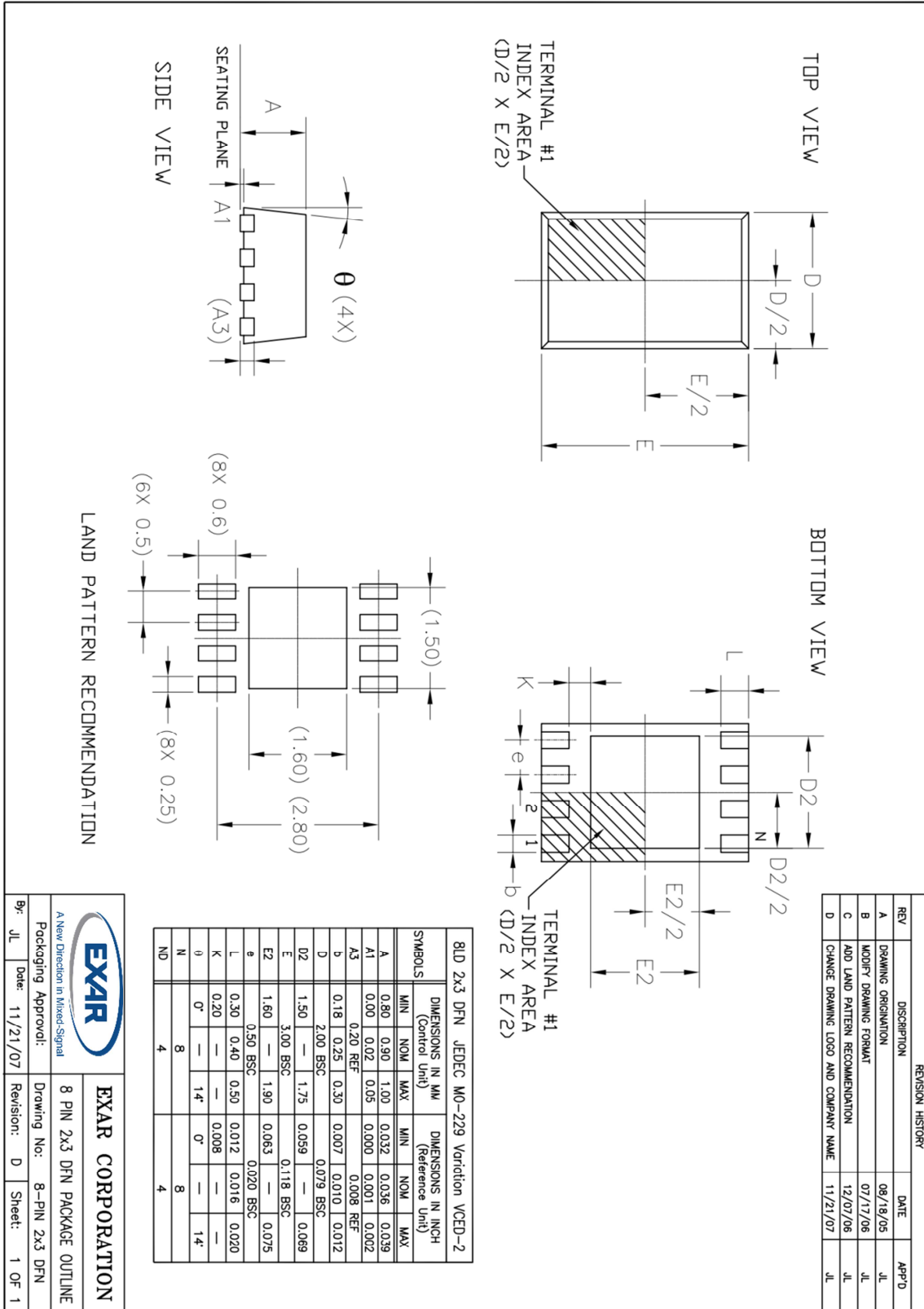

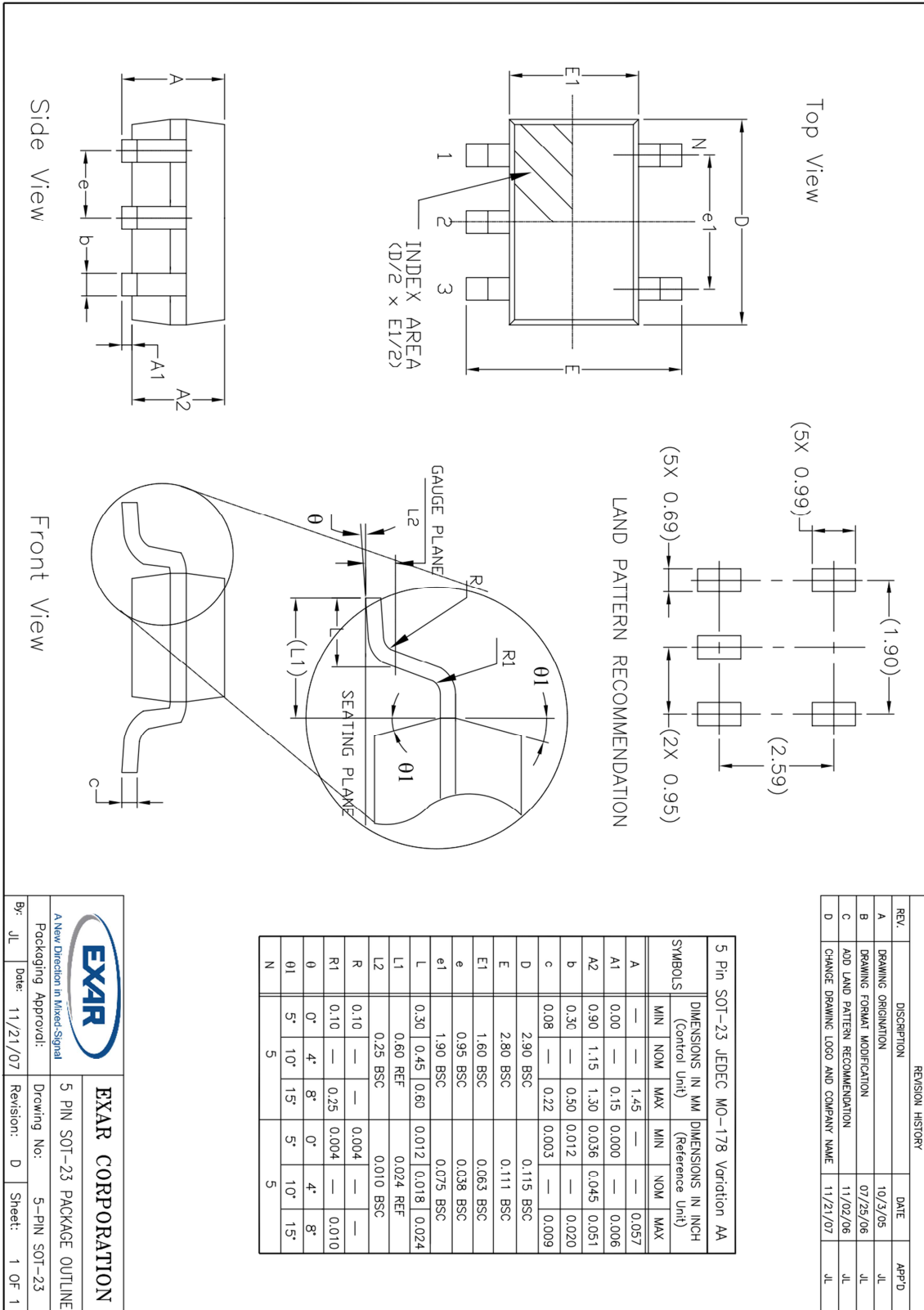



A New Direction in Mixed-Signal

SPX3819

500mA Low-Noise LDO Voltage Regulator

REVISION HISTORY

Revision	Date	Description
2.0.0	08/23/12	Reformat of Datasheet Addition of SPX3819R2-L and SPX3819R2-L/TR part numbers
2.0.1	12/02/13	Added Storage Temperature Range and Junction Temperature in ABS MAX Ratings.
2.0.2	05/20/14	Updated package drawings and corrected DFN-8 package marking information [ECN 1423-03 6/3/14]

FOR FURTHER ASSISTANCE

Email:

customersupport@exar.com

powertechsupport@exar.com

Exar Technical Documentation:

<http://www.exar.com/TechDoc/default.aspx?>



EXAR CORPORATION

HEADQUARTERS AND SALES OFFICES

48720 Kato Road

Fremont, CA 94538 – USA

Tel.: +1 (510) 668-7000

Fax: +1 (510) 668-7030

www.exar.com

NOTICE

EXAR Corporation reserves the right to make changes to the products contained in this publication in order to improve design, performance or reliability. EXAR Corporation assumes no responsibility for the use of any circuits described herein, conveys no license under any patent or other right, and makes no representation that the circuits are free of patent infringement. Charts and schedules contained herein are only for illustration purposes and may vary depending upon a user's specific application. While the information in this publication has been carefully checked; no responsibility, however, is assumed for inaccuracies.

EXAR Corporation does not recommend the use of any of its products in life support applications where the failure or malfunction of the product can reasonably be expected to cause failure of the life support system or to significantly affect its safety or effectiveness. Products are not authorized for use in such applications unless EXAR Corporation receives, in writing, assurances to its satisfaction that: (a) the risk of injury or damage has been minimized; (b) the user assumes all such risks; (c) potential liability of EXAR Corporation is adequately protected under the circumstances.

Reproduction, in part or whole, without the prior written consent of EXAR Corporation is prohibited.