

GENERAL DESCRIPTION

The SP6200 and SP6201 are CMOS Low Dropout (LDO) regulators designed to meet a broad range of applications that require accuracy, speed and ease of use.

These LDOs offer extremely low quiescent current which only increases slightly under load, thus providing advantages in ground current performance over bipolar LDOs. The LDOs handle an extremely wide load range and guarantee stability with a 1 μ F ceramic output capacitor. They have excellent low frequency Power Supply Rejection Ratio (PSRR), not found in other CMOS LDOs and thus offer exceptional Line Regulation. High frequency PSRR is better than 40dB up to 400kHz. Load Regulation is excellent and temperature stability is comparable to bipolar LDOs. An enable feature is provided on all versions.

Both LDOs are available in fixed & adjustable output voltage versions and come in an industry standard 5-pin SOT-23 and small 2X3mm 8-pin DFN packages. A V_{OUT} good indicator is provided on all fixed output versions.

APPLICATIONS

- **Battery-Powered Systems**
- **Medical Equipments**
- **MP3/CD Players**
- **Digital Cameras**

FEATURES

- **100mA/200mA Output Current**
 - SP6200: 100mA – SP6201: 200mA
 - Low Dropout Voltage: 160mV @ 100mA
- **2.5V to 6.0V Input Voltage**
 - Fixed and Adjustable Output Voltage
 - 2% Output Voltage Accuracy
- **Ultra Low Ground Current:**
 - 200 μ A @ 200mA & 28 μ A @ 100 μ A Load
- **Tight Load and Line Regulation**
- **78dB PSRR @ 1KHz**
- **RESET/Power Good Output**
- **Logic-Controlled Electronic Enable**
- **Unconditionally Stable with 1 μ F Ceramic Capacitor**
- **Current Limit and Thermal Protection**
- **RoHS Compliant "Green"/Halogen Free 5-Pin SOT23 and 8-Pin DFN Packages**

TYPICAL APPLICATION DIAGRAM

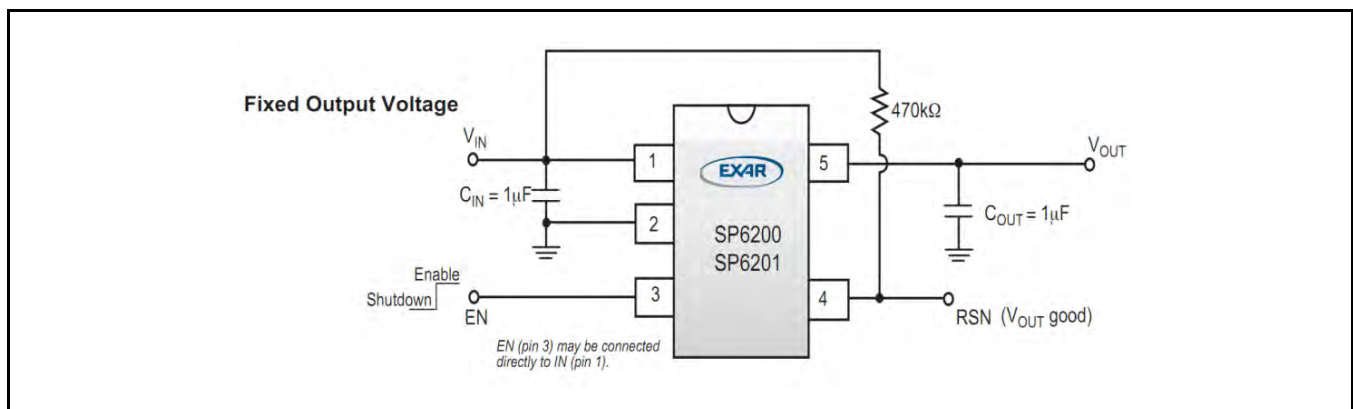

Fig. 1: SP6200 / SP6201 Application Diagram



ABSOLUTE MAXIMUM RATINGS

These are stress ratings only and functional operation of the device at these ratings or any other above those indicated in the operation sections of the specifications below is not implied. Exposure to absolute maximum rating conditions for extended periods of time may affect reliability.

Supply Input Voltage (V_{IN}) -2V to 7V
 Output Voltage (V_{OUT})..... -0.6 to ($V_{IN} + 1V$)
 Enable Input Voltage (V_{EN})..... -2V to 7V
 Storage Temperature -65°C to +150°C
 Power Dissipation Internally Limited¹
 Lead Temperature (Soldering, 5 sec) 260°C

OPERATING RATINGS

Input Voltage Range V_{IN} +2.5V to +6V
 Enable Input Voltage (V_{EN}) 0V to 6V
 Junction Temperature Range -40°C to 125°C
 Thermal Resistance
 SOT-23-5 (θ_{JA}) 191°C/W
 DFN-8 (θ_{JA}) 59°C/W

Note 1: Maximum power dissipation can be calculated using the formula: $PD = (T_J(max) - T_A) / \theta_{JA}$, where $T_J(max)$ is the junction temperature, T_A is the ambient temperature and θ_{JA} is the junction-to-ambient thermal resistance. θ_{JC} is 6°C/W for this package. Exceeding the maximum allowable power dissipation will result in excessive die temperature and the regulator will go into thermal shutdown mode.

ELECTRICAL SPECIFICATIONS

Specifications with standard type are for an Operating Junction Temperature of $T_J = 25^\circ C$ only; limits applying over the full Operating Junction Temperature range are denoted by a “•”. Minimum and Maximum limits are guaranteed through test, design, or statistical correlation. Typical values represent the most likely parametric norm at $T_J = 25^\circ C$, and are provided for reference purposes only. Unless otherwise indicated, $V_{IN} = (V_{OUT} + 1V)$, $V_{OUT} = 5V$ for Adjustable version, $C_{IN} = 1.0\mu F$, $C_{OUT} = 1.0\mu F$ and $I_L = 100\mu A$, $T_J = 25^\circ C$.

| Parameter | Min. | Typ. | Max. | Units | Conditions | |
|---|----------|------------------------------|------------------------------|------------------|---|--|
| Output Voltage Accuracy, (V_O) | -2 -3 | | 2 3 | % | • Variation from specified V_{OUT} | |
| Reference Voltage | 1.213 | 1.250 | 1.287 | V | • Adjustable version only | |
| Output Voltage Temperature Coefficient ² ($\Delta V_O/\Delta T$) | | 60 | | ppm/°C | | |
| Minimum Supply Voltage | | 2.50 2.55 2.70 3.00 | 2.70 2.80 2.95 3.50 | V V V V | $I_L = 100\mu A$ $I_L = 50mA$ $I_L = 100mA$ $I_C = 200mA$ | |
| Line Regulation, ($\Delta V_O/V_{IN}$) | | 0.03 | 0.2 | %/V | • $V_{IN} = (V_{OUT} + 1V)$ to 6V | |
| Load Regulation ³ ($\Delta V_O/V_O$) | | 0.07 0.14 | 0.25 0.50 | % % | • $I_L = 0.1mA$ to 100mA, SP6200 • $I_L = 0.1mA$ to 200mA, SP6201 | |
| SP6200-1.5V & 1.8 Load Reg. SP6201-1.5V & 1.8 Load Reg. | | 0.3 0.3 | 1 1 | % % | $I_L = 0.1mA$ to 100mA, $V_{IN} = 2.95V$ $I_L = 0.1mA$ to 200mA, $V_{IN} = 3.5V$ | |
| Dropout Voltage ⁴ ($V_{IN} - V_O$) (Not applicable to voltage options below 2.7V) | | 0.2 | 4 | mV | • $I_L = 100\mu A$ | |
| | | | 7 | | | |
| | | | 70 | 120 | mV | • $I_L = 50mA$ |
| | | | 160 | 160 | | |
| | | | 160 | 250 | mV | • $I_L = 100mA$ |
| | | | 320 | 400 | mV | • $I_L = 200mA$, SP6201 Only |
| Shutdown Quiescent Current (I_{GND}) | | 0.01 | 1 | μA | • $V_{EN} \geq 0.4V$ | |
| | | | 28 | 40 | μA | • $V_{EN} \geq 2.0V$, $I_L = 100 \mu A$ |
| Ground Pin Current ⁵ (I_{GND}) | | | 45 | | | |
| | | 110 | 200 | μA | • $V_{EN} \geq 2.0V$, $I_L = 100 mA$, SP6200 only (for 1.5 & 1.8, $V_{IN} = 2.95$) | |
| | | | 250 | | | |
| | | 200 | 400 | μA | • $V_{EN} \geq 2.0V$, $I_L = 200mA$, SP6201 Only (for 1.5 & 1.8, $V_{IN} = 3.5$) | |
| | | | 500 | | | |
| Power Supply Rejection Ratio, (PSRR) | | 78 | | dB | Frequency = 100Hz, $I_L = 10mA$ | |
| | | 40 | | | Frequency = 400Hz, $I_L = 10mA$ | |
| Current Limit, (I_{CL}) | 100 | 140 | 200 | mA | • SP6200 | |

| Parameter | Min. | Typ. | Max. | Units | Conditions |
|---|------|------|------|---------------|---|
| | 300 | 420 | 600 | | • SP6201 |
| Thermal Limit | | 162 | | °C | Turns On |
| | | 147 | | | Turns Off |
| Thermal Regulation ⁶ ($\Delta V_O/\Delta P_D$) | | 0.05 | | %/W | |
| Output Noise, (e_{NO}) | | 150 | | μV_{rms} | $I_L = 50mA$, $C_L = 1\mu F$ 0.1 μF from V_{OUT} to Adj. 10Hz to 100kHz |
| ENABLE INPUT | | | | | |
| Enable Input Logic-Low Voltage, (V_{IL}) | | | 0.4 | V | • Regulator Shutdown |
| Enable Input Logic-High Voltage, (V_{IH}) | 1.6 | | | V | • Regulator Enabled |
| Enable Input Current, (I_{IL}), (I_{IH}) | | 0.01 | 1 | μA | • $V_{IL} < 0.4V$ |
| | | 0.01 | 1 | μA | • $V_{IH} > 2.0V$ |
| Reset Not Output | -2 | -4 | -6 | % | Threshold |

Note 2: Output voltage temperature coefficient is defined as the worst case voltage change divided by the total temperature range.

Note 3: Load Regulation is measured at constant junction temperature using low duty cycle pulse testing. Parts are tested for load regulation in the load range; from 0.1mA to 100mA, SP6200; from 0.1mA to 200mA, SP6201. Changes in output voltage due to heating effects are covered by the thermal regulation specification. Not applicable to output voltages less than 2.5V.

Note 4: Dropout Voltage is defined as the input to output differential at which the output voltage drops 2% below its nominal value measured at 1V differential. Not applicable to output voltages less than 2.7V.

Note 5: Ground pin current is the regulator quiescent current. The total current drawn from the supply is the sum of the load current plus the ground pin current.

Note 6: **Thermal regulation is defined as the change in output voltage at a time "t" after a change** in power dissipation is applied, excluding load or line regulation effects. Specifications are for a 100mA load pulse at $V_{IN} = 6V$ for $t = 10ms$.

BLOCK DIAGRAMS

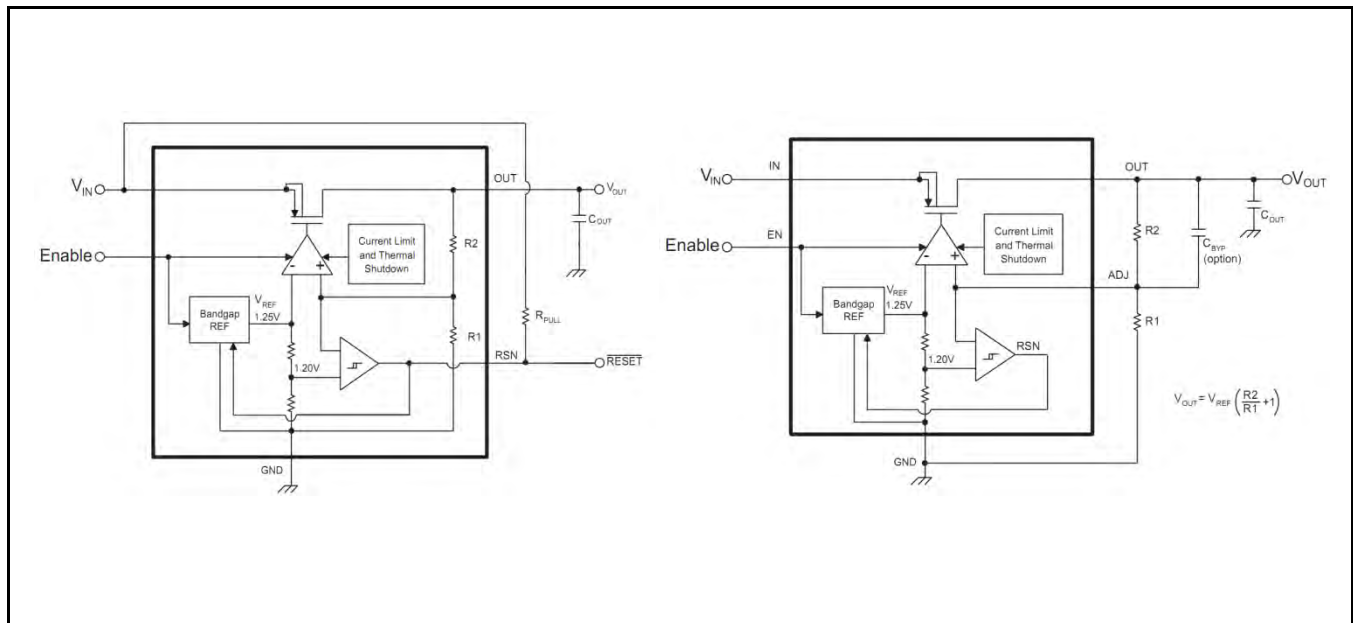

Fig. 2: Fixed Voltage and Adjustable Regulators

PIN ASSIGNMENT

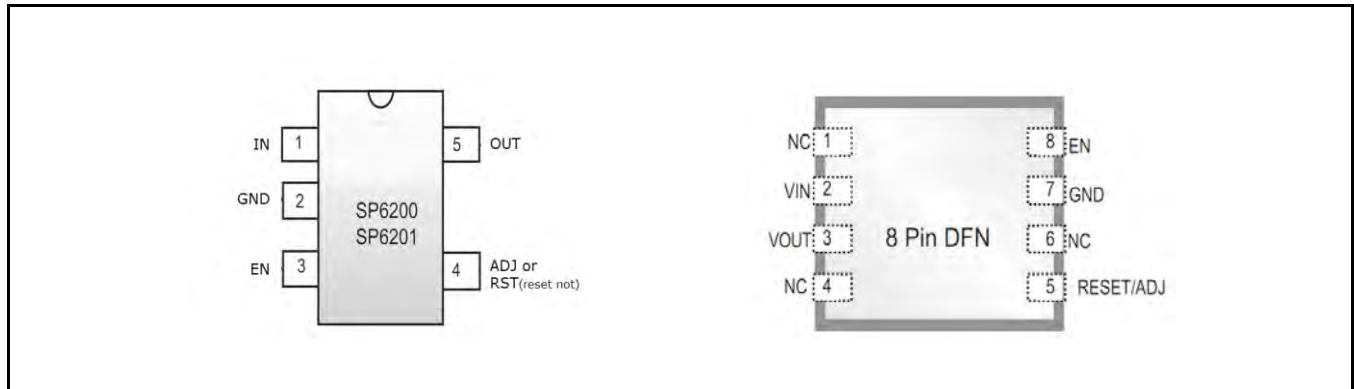

Fig. 3: SP6200 / SP6201 Pin Assignment

PIN DESCRIPTION

SOT 23-5

| Name | SOT-23-5 | Description |
|--------------------|----------|--|
| IN | 1 | Power Supply Input |
| GND | 2 | Ground Terminal |
| EN | 3 | Enable/Shutdown Input – CMOS or TTL compatible Input - Logic high = enable - Logic low = shutdown |
| RST(Reset not)/ADJ | 4 | Reset/Power Good - Fixed voltage option: Open Drain indicating that V_{OUT} is good. Adjustable Input – Adjustable voltage option: Adjustable regulator feedback input. Connect to a resistive voltage-Divider network. |
| OUT | 5 | Regulator Output Voltage |

8 PIN DFN

| Name | DFN-8 | Description |
|-----------|-------|--|
| NC | 1 | No Connect |
| V_{IN} | 2 | Power Supply Input |
| V_{OUT} | 3 | Regulator Output Voltage |
| NC | 4 | No Connect |
| RESET/ADJ | 5 | Reset/Power Good - Fixed voltage option: Open Drain indicating that V_{OUT} is good. Adjustable Input – Adjustable voltage option: Adjustable regulator feedback input. Connect to a resistive voltage-Divider network. |
| NC | 6 | No Connect |
| NC | 7 | No Connect |
| EN | 8 | Enable/Shutdown Input – CMOS or TTL compatible Input - Logic high = enable Logic low = shutdown |



SP6200 / SP6201

100mA/200mA Micropower CMOS LDO Regulators

ORDERING INFORMATION

| Part Number | Temperature Range | Marking | Package | Packing Quantity | Voltage Option | Note 1 | | |
|---------------------|---------------------------------|---------------------------------|----------------|------------------|----------------|----------------|------------|--------------|
| SP6200EM5-L-3-0 | -40°C ≤ T _J ≤ +125°C | E30 | SOT-23-5 | Bulk | 3.0V | Halogen Free | | |
| SP6200EM5-L-3-0/TR | | | | 2.5K/Tape & Reel | | | | |
| SP6201EM5-L | -40°C ≤ T _J ≤ +125°C | FADJ | SOT-23-5 | Bulk | Adjustable | Halogen Free | | |
| SP6201EM5-L/TR | | | | 2.5K/Tape & Reel | | | | |
| SP6201EM5-L-1-5 | | F15 | | Bulk | 1.5V | Halogen Free | | |
| SP6201EM5-L-1-5/TR | | | | 2.5K/Tape & Reel | | | | |
| SP6201EM5-L-1-8 | | F18 | | Bulk | 1.8V | Halogen Free | | |
| SP6201EM5-L-1-8/TR | | | | 2.5K/Tape & Reel | | | | |
| SP6201EM5-L-2-5 | | F25 | | Bulk | 2.5V | Halogen Free | | |
| SP6201EM5-L-2-5/TR | | | | 2.5K/Tape & Reel | | | | |
| SP6201EM5-L-2-85 | | F285 | | Bulk | 2.85V | Halogen Free | | |
| SP6201EM5-L-2-85/TR | | | | 2.5K/Tape & Reel | | | | |
| SP6201EM5-L-3-0 | | F30 | | Bulk | 3.0V | Halogen Free | | |
| SP6201EM5-L-3-0/TR | | | | 2.5K/Tape & Reel | | | | |
| SP6201EM5-L-3-3 | | F33 | | Bulk | 3.3V | Halogen Free | | |
| SP6201EM5-L-3-3/TR | | | | 2.5K/Tape & Reel | | | | |
| SP6201EM5-G-3-3 | | UBWW | | Bulk | 3.3V | Halogen Free | | |
| SP6201EM5-G-3-3/TR | | | | 2.5K/Tape & Reel | | | | |
| SP6201EM5-L-5-0 | | F50 | | Bulk | 5.0V | Halogen Free | | |
| SP6201EM5-L-5-0/TR | | | | 2.5K/Tape & Reel | | | | |
| SP6201ER-L | | -40°C ≤ T _J ≤ +125°C | | A0 | DFN8 | Bulk | Adjustable | Halogen Free |
| SP6201ER-L/TR | | | | YWW XXX | | 3K/Tape & Reel | | |
| SP6201ER-L-1-8 | B0 | | Bulk | 1.8V | | Halogen Free | | |
| SP6201ER-L-1-8/TR | YWW XXX | | 3K/Tape & Reel | | | | | |
| SP6201ER-L-3-3 | C0 | | Bulk | 3.3V | | Halogen Free | | |
| SP6201ER-L-3-3/TR | YWW XXX | | 3K/Tape & Reel | | | | | |

"Y" = Year - "WW" = Work Week - "XXX" = Lot Number; when applicable.

TYPICAL PERFORMANCE CHARACTERISTICS

All data taken at 25°C, $V_{IN} = 5.5V$, $I_O = 0.1mA$, $C_{IN} = C_{OUT} = 1\mu F$, unless otherwise specified - Schematic and BOM from Application Information section of this datasheet.

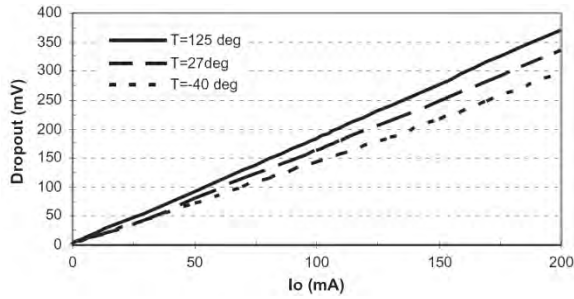

Fig. 4: Dropout vs. I_O (SP6201 fixed 3.0V)

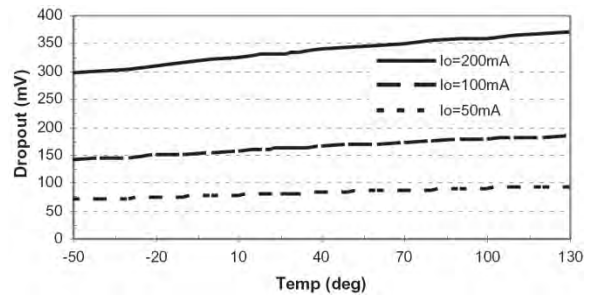

Fig. 5: Dropout vs. Temp (SP6201 fixed 3.0V)

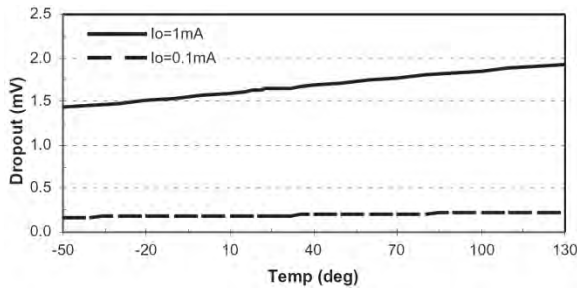

Fig. 6: Dropout vs. Temp (SP6201 fixed 3.0V)

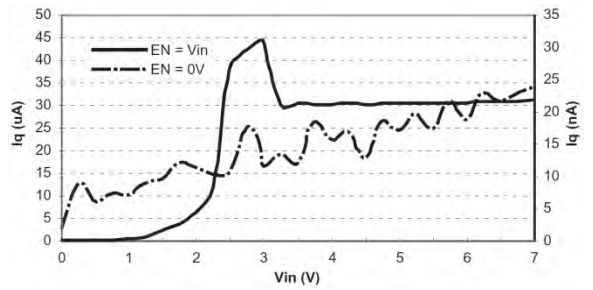

Fig. 7: I_q vs. V_{in} (fixed 3.0V, $I_O=0\mu A$)

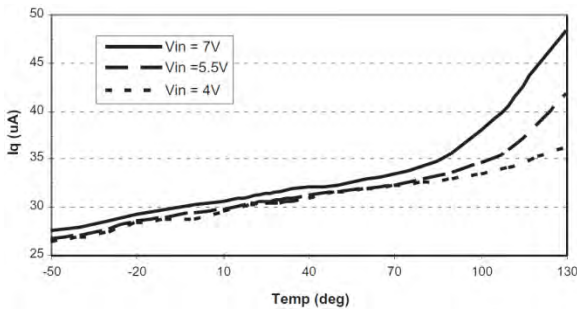

Fig. 8: I_q vs. Temp (SP6201 fixed 3.0V, $EN=V_{in}$, $I_O=0\mu A$)

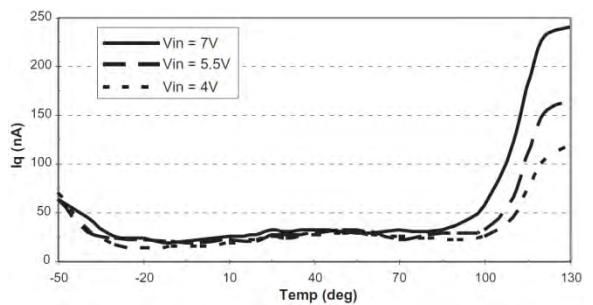

Fig. 9: I_q vs. Temp (SP6201 fixed 3.0V, $EN=0V$, $I_O=0\mu A$)

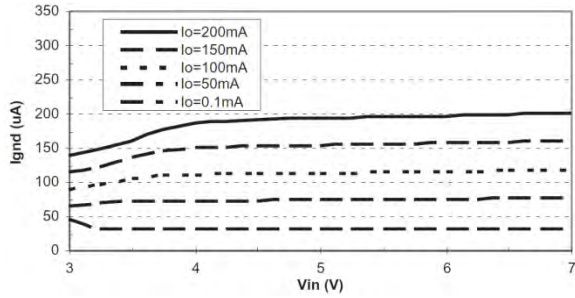

Fig. 10: I_{GND} vs. V_{IN} (SP6201 fixed 3.0V)

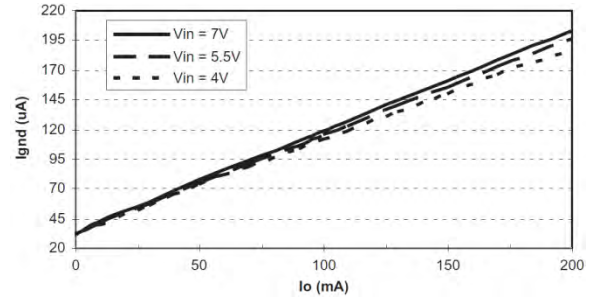

Fig. 11: I_{GND} vs. I_O (SP6201 fixed 3.0V)

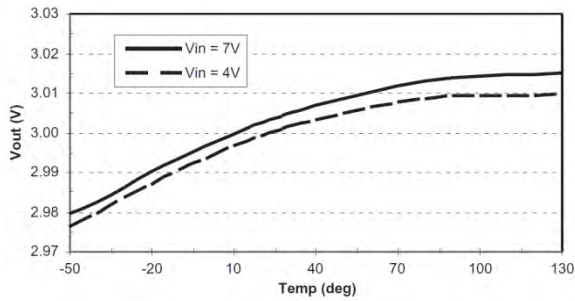

Fig. 12: V_{OUT} vs. Temp (fixed 3.0V)

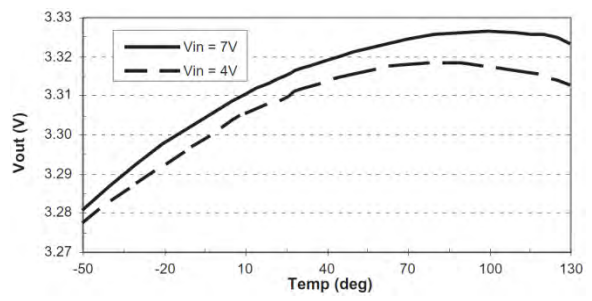

Fig. 13: V_{OUT} vs. Temp (fixed 3.3V)

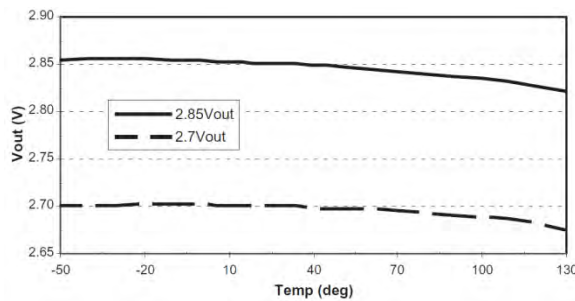

Fig. 14: V_{OUT} vs. Temp (adjustable)

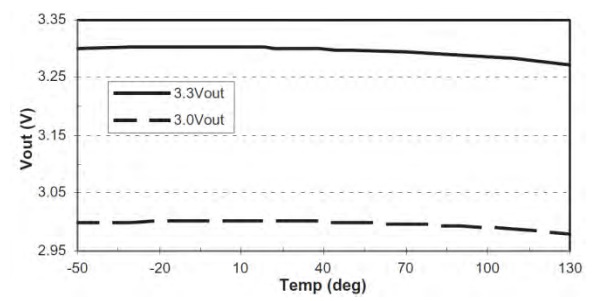

Fig. 15: V_{OUT} vs. Temp (adjustable)

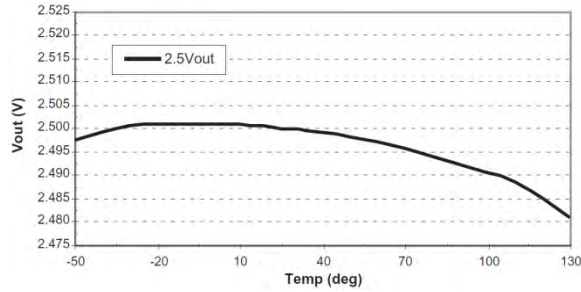

Fig. 16: V_{OUT} vs. Temp (adjustable)

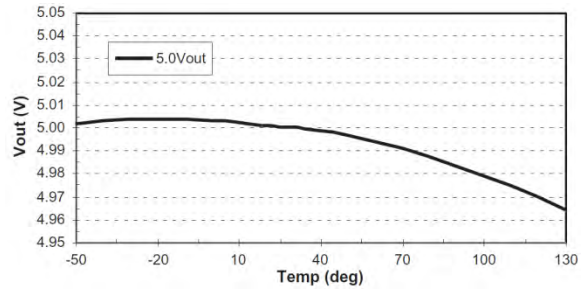

Fig. 17: V_{OUT} vs. Temp (adjustable)

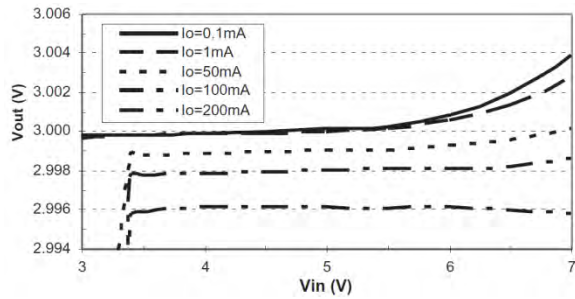

Fig. 18: Line Regulation (SP6201 fixed 3.0V)

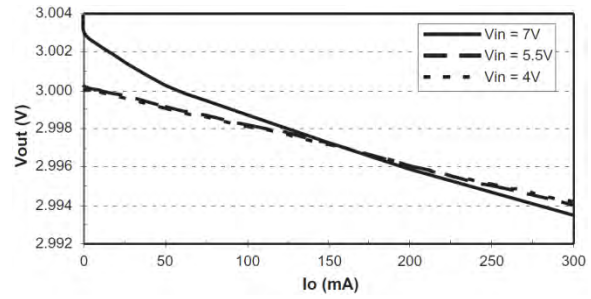

Fig. 19: Load Regulation (SP6201 fixed 3.0V)

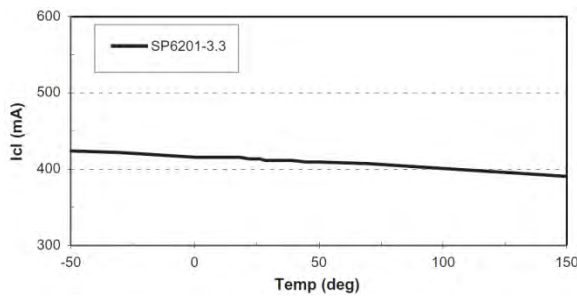

Fig. 20: Current Limit vs. Temp (fixed 3.3V, $V_{IN}=4V$)

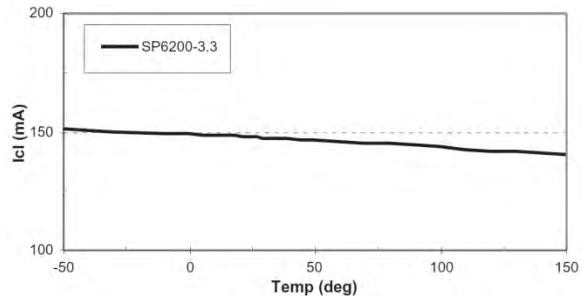

Fig. 21: Current Limit vs. Temp (fixed 3.3V, $V_{IN}=4V$)

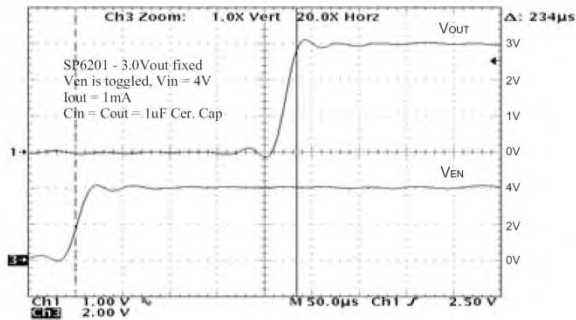

Fig. 22: Turn on time, $I_O=1\text{mA}$, $4V_{IN}$

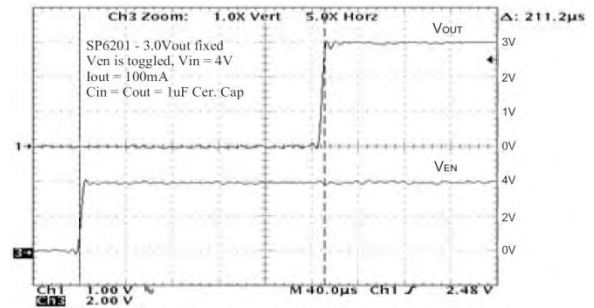

Fig. 23: Turn on time, $I_O=100\text{mA}$, $4V_{IN}$

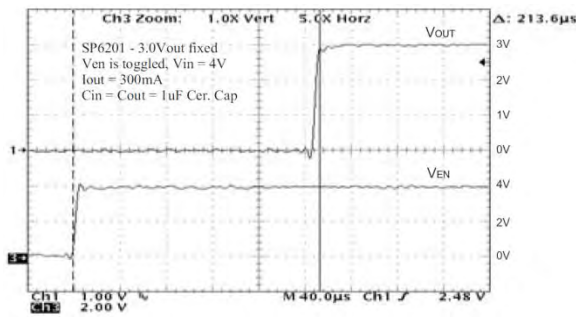

Fig. 24: Turn on time, $I_O=300\text{mA}$, $4V_{IN}$

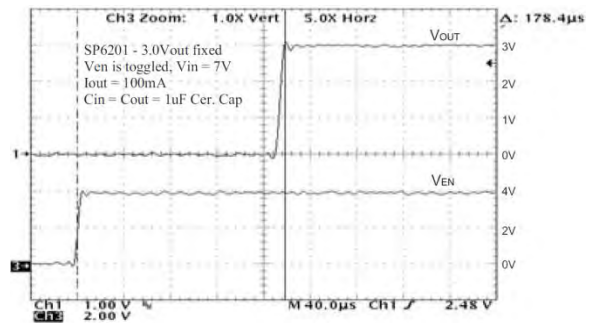

Fig. 25: Turn on time, $I_O=100\text{mA}$, $7V_{IN}$

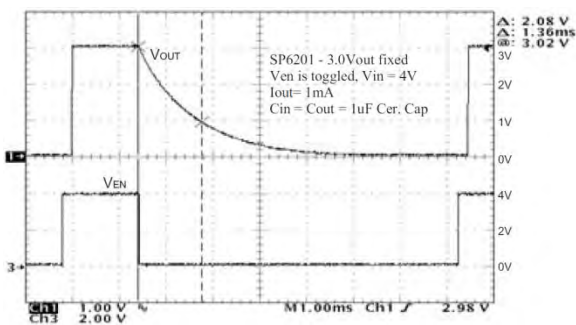

Fig. 26: Turn off time, $I_O=1\text{mA}$, $4V_{IN}$

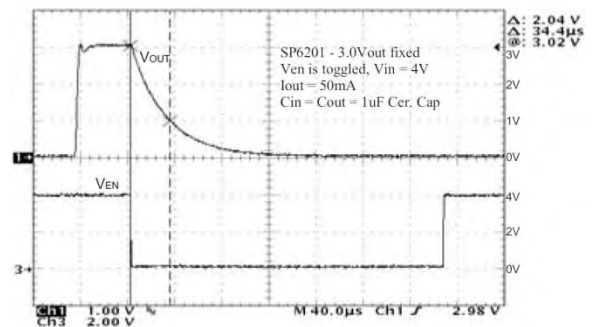

Fig. 27: Turn off time, $I_O=50\text{mA}$, $4V_{IN}$

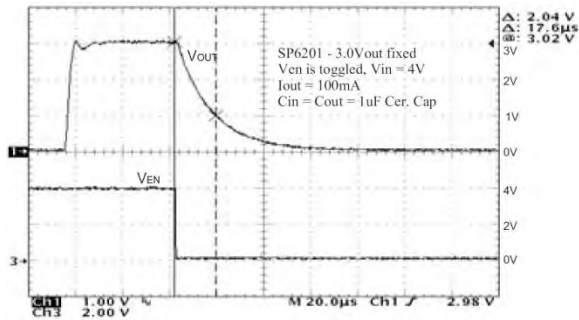

Fig. 28: Turn off time, $I_o=100\text{mA}$, $4V_{IN}$

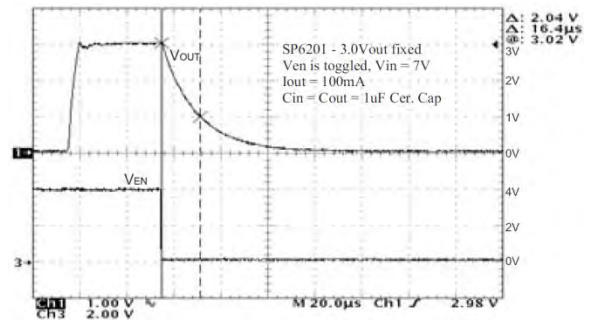

Fig. 29: Turn off time, $I_o=100\text{mA}$, $7V_{IN}$

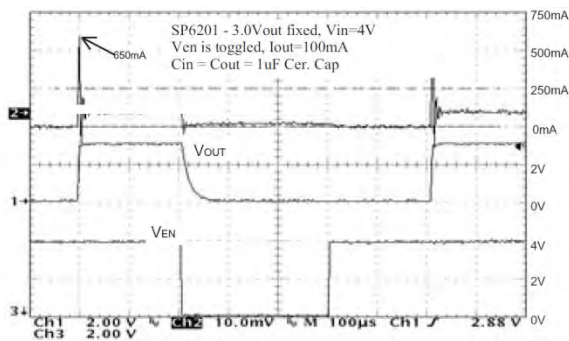

Fig. 30: Inrush Current, $I_o=100\text{mA}$

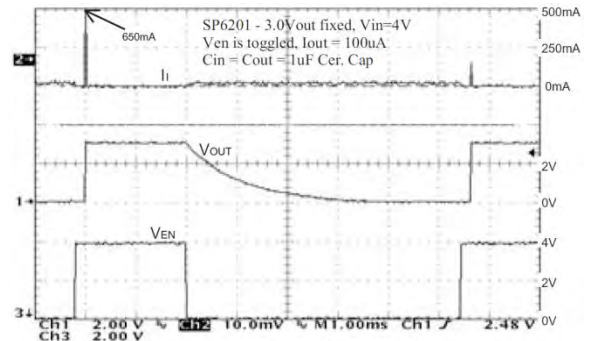

Fig. 31: Inrush Current, $I_o=100\mu\text{A}$

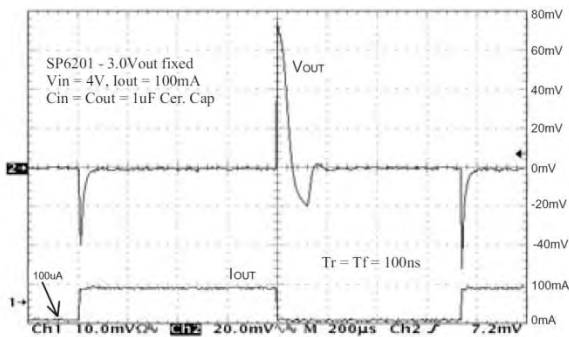

Fig. 32: Load Transient Response, 100mA step, $4V_{IN}$

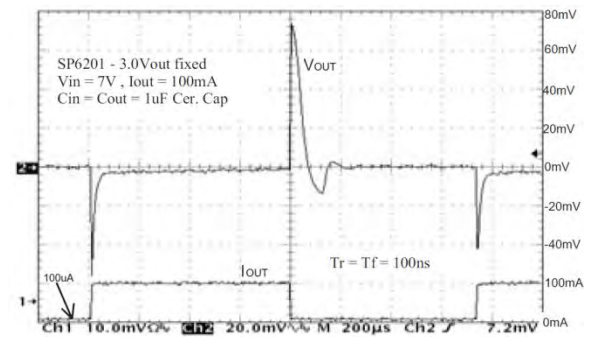

Fig. 33: Load Transient Response, 100mA step, $7V_{IN}$

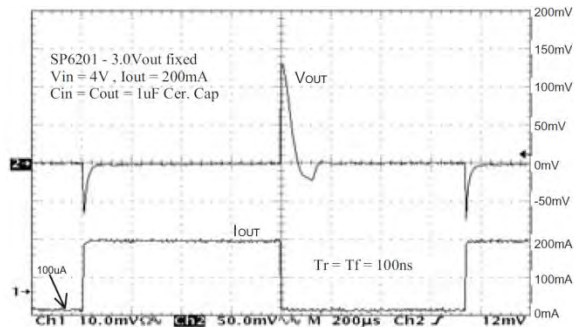

Fig. 34: Load Transient Response, 200mA step, 4V_{IN}

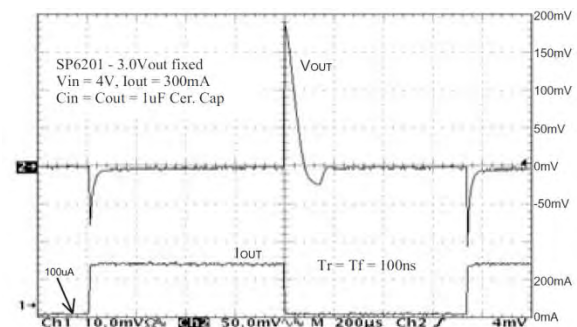

Fig. 35: Load Transient Response, 300mA step, 4V_{IN}

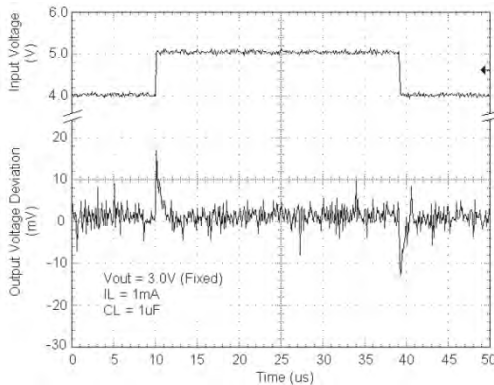

Fig. 36: Line Transient Response

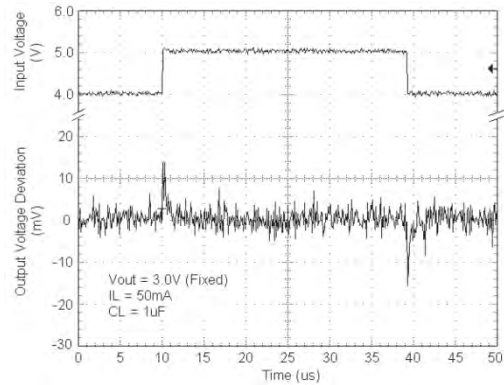

Fig. 37: Line Transient Response

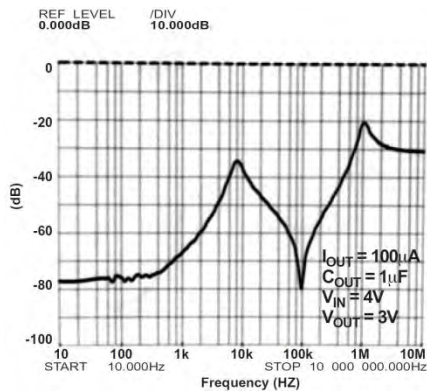

Fig. 38: Power Supply Rejection Ratio

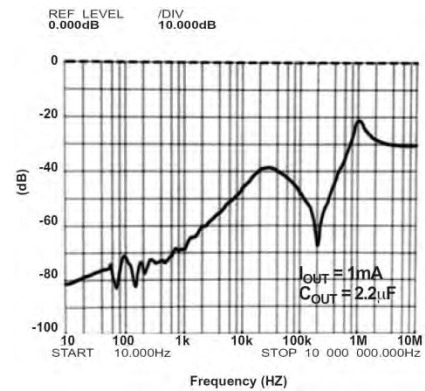

Fig. 39: Power Supply Rejection Ratio

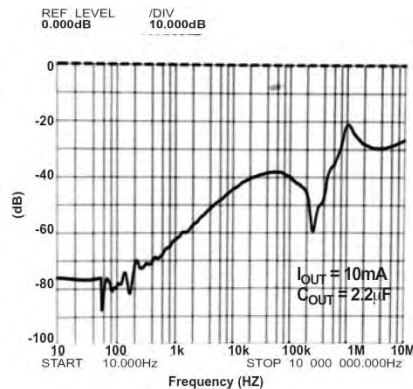

Fig. 40: Power Supply Rejection Ratio

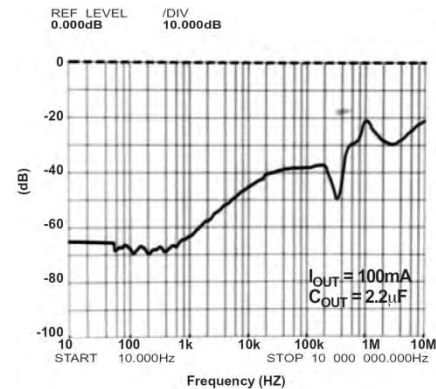

Fig. 41: Power Supply Rejection Ratio

THEORY OF OPERATION

GENERAL OVERVIEW

The SP6200 and SP6201 are CMOS LDOs designed to meet a broad range of applications that require accuracy, speed and ease of use. These LDOs offer extremely low quiescent current which only increases slightly under load, thus providing advantages in ground current performance over bipolar LDOs. The LDOs handle an extremely wide **load range and guarantee stability with a 1µF ceramic output capacitor**. They have excellent low frequency PSRR, not found in other CMOS LDOs and thus offer exceptional Line Regulation. High frequency PSRR is better than 40dB up to 400kHz. Load Regulation is excellent and temperature stability is comparable to bipolar LDOs. Thus, overall system accuracy is maintained under all DC and AC conditions. Enable feature is provided on all versions. A Vout good indicator (RSN pin) is provided in all the fixed output voltage devices. An adjustable output version is also available. Current Limit and Thermal protection is provided internally and is well controlled.

ARCHITECTURE

The SP6200 and SP6201 are only different in their current limit threshold. The SP6200 has a current limit of 140mA, while the SP6201 current limit is 420mA. The SP6201 can provide pulsed load current of 300mA. The

LDOs have a two stage amplifier which handles an extremely wide **load range (10µA to 300mA) and guarantees stability with a 1µF ceramic load capacitor**. The LDO amplifier has excellent gain and thus touts PSRR performance not found in other CMOS LDOs. The amplifier guarantees no overshoot on power up or while enabled through the EN pin. The amplifier also contains an active pull down, so that when the load is removed quickly the output voltage transient is minimal; thus output deviation due to load transient is small and fairly well matched when connecting and disconnecting the load.

An accurate 1.250V bandgap reference is bootstrapped to the output in fixed output versions of 2.7V and higher. This increases both the low frequency and high frequency PSRR. The adjustable version also has the bandgap reference bootstrapped to the output, thus the lowest externally programmable output voltage is 2.7V. The 2.5V fixed output version has the bandgap always connected to the Vin pin. Unlike many LDOs, the bandgap reference is not brought out for filtering by the user. This tradeoff was made to maintain good PSRR at high frequency (PSRR can be degraded in a system due to switching noise coupling into this pin). Also, often leakages of the bypass capacitor or other components cause an error on this high impedance bandgap node. Thus, this tradeoff has been made with "ease of use" in mind.



PROTECTION

Current limit behavior is very well controlled, providing less than 10% variation in the current limit threshold over the entire temperature range for both SP6200 and SP6201. The SP6200 has a current limit of 140mA, while the SP6201 has a current limit of 420mA. Thermal shutdown activates at 162°C and deactivates at 147°C. Thermal shutdown is very repeatable with only a 2 to 3 degree variation from device to device. Thermal shutdown changes by only 1 to 2 degrees with V_{in} change from 4V to 7V.

ENABLE (SHUTDOWN NOT) INPUT

The LDOs are turned off by pulling the EN pin low and turned on by pulling it high. If it is not necessary to shut down the LDO, the EN (pin 3) should be tied to IN (pin 1) to keep the regulator output on at all time. The enable threshold is 0.9V and does not change more than 100mV over the entire temperature and V_{IN} voltage range. The lot to lot variations in Enable Threshold are also within 100mV. Shutdown current is guaranteed to be $<1\mu A$ without requiring the user to pull enable all the way to 0V. Standard TTL or CMOS levels will transition the device from totally on to totally off.

RESET NOT (V_{OUT} GOOD) OUTPUT

An accurate V_{OUT} good indicator is provided on all the fixed output version devices, pin 4 (RSN), Figure 1. This is an open drain, logic output that can be used to hold a microprocessor or microcontroller in a RESET condition when its power supplied by V_{OUT} is 4% out of nominal regulation. A 1% hysteresis is included in the Reset Not function, so that false alarms are not issued as a result of LDO's output noise. The Reset Not function reacts in 10 to 50 μs .

ADJUSTABLE OUTPUT VERSION

The adjustable version can be programmed to any voltage from 2.7V to 6V for the industrial temperature range; 2.5V to 6V for the commercial temperature range. The output cannot be programmed below 2.5V due a headroom restriction. Since the bandgap is

bootstrapped to the output, the output voltage must be above the minimum bandgap supply voltage. The bandgap requires 2.7V or greater at -40°C and requires 2.5V or greater at 0°C. The regulator's output can be adjusted to a specific output voltage by using two external resistors, see block diagram. The resistor's set the output voltage based on the following equation:

$$V_{OUT} = 1.25 \times \left(1 + \frac{R_2}{R_1}\right)$$

Resistor values are not critical because the ADJ node has a high input impedance, but for **best results use resistors of 470k Ω or less.** A capacitor from ADJ to V_{OUT} pin provides improved noise performance as is shown in the following plot.

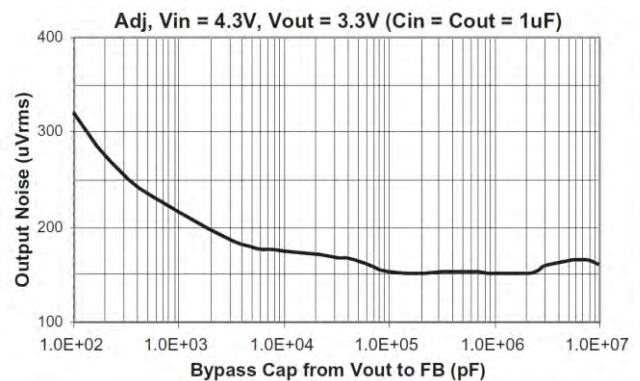

Fig. 42: Noise Performance 10Hz to 100kHz

INPUT CAPACITOR

A small capacitor, 1 μF or higher, is required from V_{IN} to GND to create a high frequency bypass for the LDO amplifier. Any ceramic or tantalum capacitor may be used at the input. Capacitor ESR (effective series resistance) should be smaller than 3 Ω .

OUTPUT CAPACITOR

An output capacitor is required between V_{OUT} and GND to prevent oscillation; a capacitance as low as 0.22 μF can fulfill stability requirements in most applications. A 1 μF capacitor will ensure unconditional stability from no load to full load over the entire input voltage, output voltage and temperature range. Larger capacitor values improve the



regulator's transient response. The output capacitor value may be increased without limit. The output capacitor should have an ESR (effective series resistance) below 5Ω and a resonant frequency above 1MHz.

No Load Stability

The SP6200/SP6201 will remain stable and in regulation with no external load (other than the internal voltage driver) unlike many other voltage regulators. This is especially important in CMOS RAM keep-alive applications.

Thermal Considerations

The SP6200 is designed to provide 100mA of continuous current, while the SP6201 will provide 200mA of continuous current. Maximum power dissipation can be calculated based on the output current and the voltage drop across the part. To determine the maximum power dissipation in the package, use the junction-to-ambient thermal resistance of the device and the following basic equation:

$$P_D = \frac{(T_{J(MAX)} - T_A)}{\theta_{JA}}$$

$T_{J(MAX)}$ is the maximum junction temperature of the die and is 125°C. T_A is the ambient operating. θ_{JA} is the junction-to-ambient thermal resistance for the regulator and is layout dependent.

The actual power dissipation of the regulator circuit can be determined using one simple equation:

$$P_D = \frac{125^\circ\text{C} - 25^\circ\text{C}}{191^\circ\text{C}/\text{W}} = 0.52\text{W}$$

$$P_D = (V_{IN} - V_{OUT}) \times I_{OUT} + V_{IN} \times I_{GND} \\ \cong (V_{IN} - V_{OUT}) \times I_{OUT}$$

Substituting $P_{D(max)}$ for P_D and solving for the operating conditions that are critical to the application will give the maximum operating conditions for the regulator circuit. For example, if we are operating the SP6201- 3.0V at room temperature, with a SOT-23-5 package on a 4 layer standard board we can determine the maximum input voltage for a set output current.

$$P_D = \frac{125^\circ\text{C} - 25^\circ\text{C}}{191^\circ\text{C}/\text{W}} = 0.52\text{W}$$

To prevent the device from entering thermal shutdown, maximum power dissipation cannot be exceeded. Using the output voltage of 3.0V and an output current of 200mA, the maximum input voltage can be determined. Ground pin current can be taken from the electrical spec's table ($I_{GND}=200\mu\text{A}$ at $I_{OUT}=200\text{mA}$). The maximum input voltage is determined as follows:

$$0.52\text{W} = (V_{IN} - 3.0\text{V}) \times 200\text{mA} + (V_{IN} \times 0.2\text{mA})$$

Solving for V_{IN} , we get:

$$V_{IN} = \frac{0.52\text{W} + 0.6\text{W}}{200.2\text{mA}}$$

After calculations, we find that the maximum input voltage of a 3.0V application at 200mA of output current in an SOT-23-5 package is 5.59V.

Dual-Supply Operation

When used in dual supply systems where the regulator load is returned to a negative supply, the output voltage must be diode clamped to ground.

PACKAGE SPECIFICATION

5 PIN SOT-23

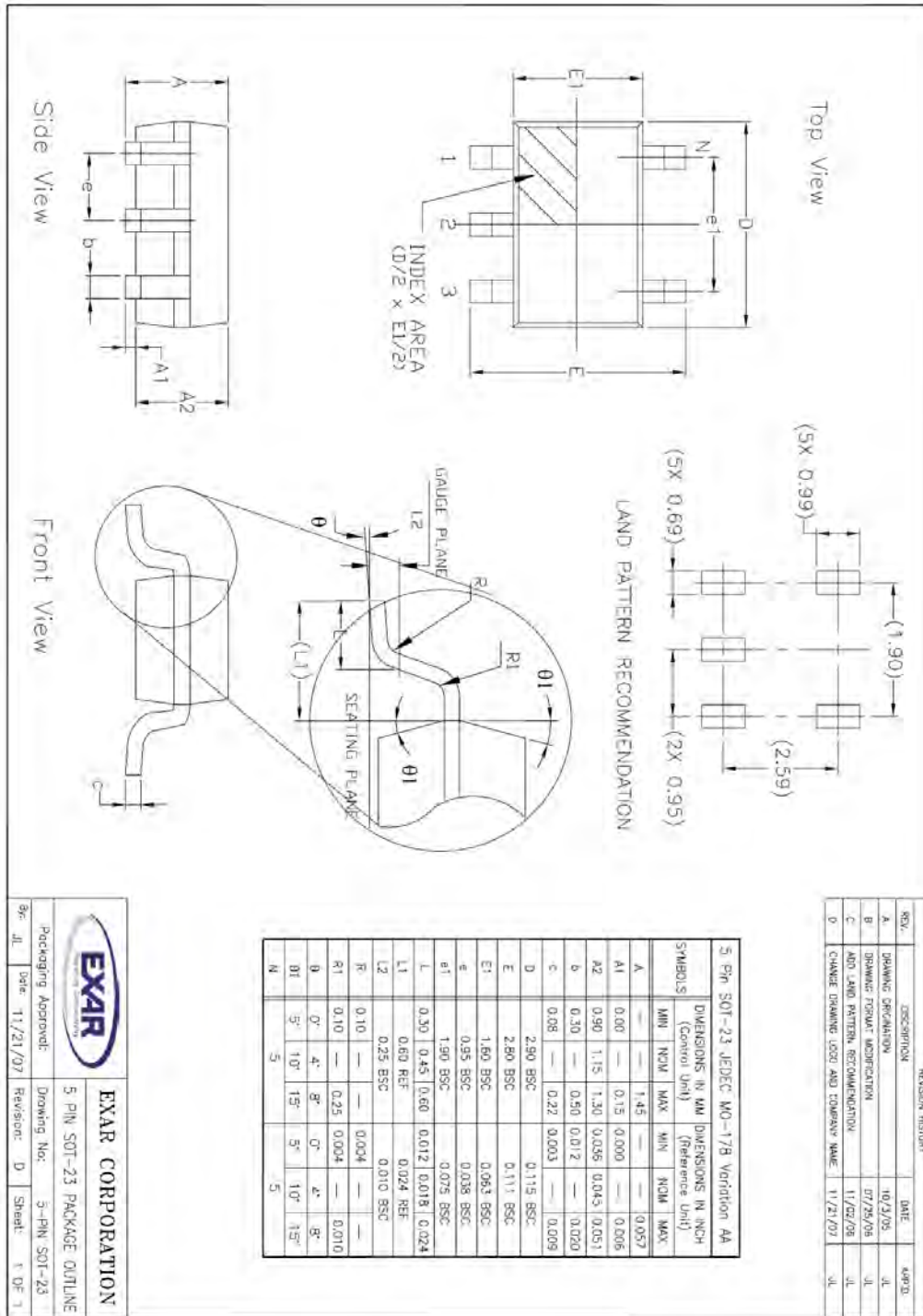

8-PIN DFN

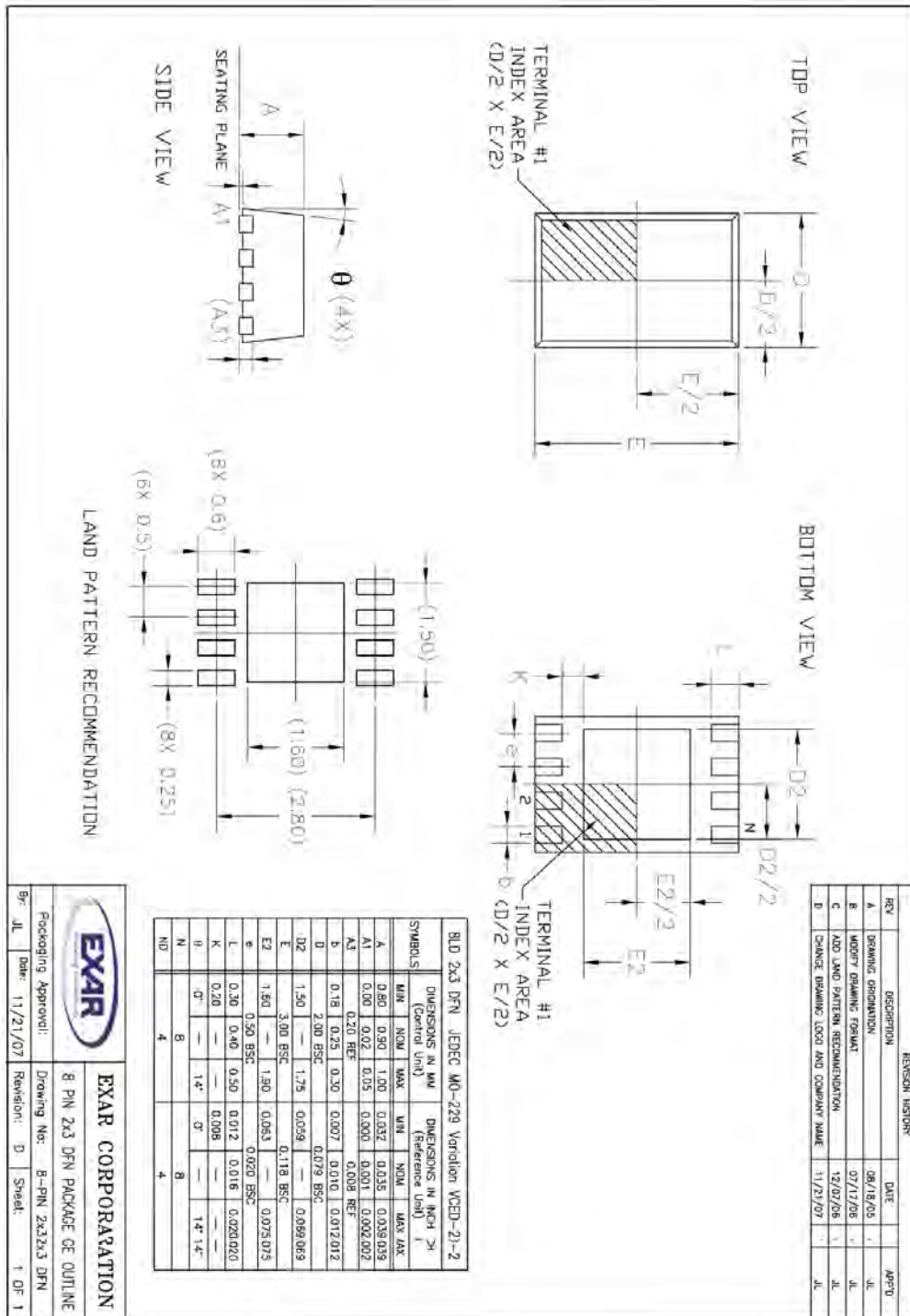



SP6200 / SP6201

100mA/200mA Micropower CMOS LDO Regulators

REVISION HISTORY

| Revision | Date | Description |
|----------|------------|--|
| 2.0.0 | 03/28/2012 | Reformatted Data Sheet Includes top package marking update. |
| 2.1.0 | 05/29/2012 | Corrected typographical error on page 1. |
| | | |

FOR FURTHER ASSISTANCE

Email:

customersupport@exar.com

Exar Technical Documentation:

<http://www.exar.com/TechDoc/default.aspx?>

EXAR CORPORATION

HEADQUARTERS AND SALES OFFICES

48720 Kato Road

Fremont, CA 94538 – USA

Tel.: +1 (510) 668-7000

Fax: +1 (510) 668-7030

www.exar.com



NOTICE

EXAR Corporation reserves the right to make changes to the products contained in this publication in order to improve design, performance or reliability. EXAR Corporation assumes no responsibility for the use of any circuits described herein, conveys no license under any patent or other right, and makes no representation that the circuits are free of patent infringement. Charts and schedules contained here in are only for illustration purposes and may vary depending upon a **user's specific application**. While the information in this publication has been carefully checked; no responsibility, however, is assumed for inaccuracies.

EXAR Corporation does not recommend the use of any of its products in life support applications where the failure or malfunction of the product can reasonably be expected to cause failure of the life support system or to significantly affect its safety or effectiveness. Products are not authorized for use in such applications unless EXAR Corporation receives, in writing, assurances to its satisfaction that: (a) the risk of injury or damage has been minimized; (b) the user assumes all such risks; (c) potential liability of EXAR Corporation is adequately protected under the circumstances.

Reproduction, in part or whole, without the prior written consent of EXAR Corporation is prohibited.