	TYPE	NUMBER	
	PRODUCT SPECIFICATION	GS-12-100	
TITLE	MEG-Array™ 81, 100, 200, 240, 300, 400 & 528 Positions	PAGE	REVISION
		1 of 13	R
		AUTHORIZED BY	DATE
D. Horchler	14 Oct 2013	CLASSIFICATION	
UNRESTRICTED			

1.0 OBJECTIVE

This specification defines the performance, test, quality, and reliability requirements of the MEG-Array™, FCI's 1.27mm x 1.27mm Grid High Density Connector System

2.0 SCOPE

This specification applies to the MEG-Array™ 1.27mm x 1.27mm Grid High Density Connector System which provides for parallel interconnection of printed wiring boards in low power applications. It covers product offerings of Eutectic SnPb BGA as well as Lead Free BGA that meets the requirements of the European Union Directive of Restrictions for Hazardous Substances (Directive 2002/95/EC). On the contact interface end, it covers precious metal plating thicknesses of 0.4 microns (15µ"), 0.8 microns (30µ") and 1.27 microns (50µ")

3.0 GENERAL

<u>PARAGRAPH</u>	<u>TITLE</u>
1.0	Objective
2.0	Scope
3.0	General
4.0	Applicable Documents
5.0	Requirements
5.1	Qualification
5.2	Material
5.3	Finish
5.4	Design and Construction
6.0	Electrical Characteristics
7.0	Mechanical Characteristics
8.0	Environmental Conditions
9.0	Quality Assurance Provisions
9.1	Equipment Calibration
9.2	Inspection Conditions
9.3	Sample Quantities and Description And Qualification Testing Sequences

4.0 APPLICABLE DOCUMENTS

4.1 DRAWINGS & APPLICATION NOTE

4.1.3	81 Position 4.0mm mated height	55714 Plug	55715 Receptacle
4.1.4	100 Position 4.0mm mated height	84512 Plug	84513 Receptacle
4.1.5	200 Position 4.0mm mated height	84516 Plug	84517 Receptacle
4.1.6	200 Position 6.0mm mated height	84516 Plug	55724 Receptacle
4.1.7	200 Position 8.0mm mated height	84516 Plug	84535 Receptacle
4.1.8	200 Position 10.0mm mated height	84530 Plug	84517 Receptacle
4.1.9	200 Position 12.0mm mated height	84530 Plug	55724 Receptacle
4.1.10	200 Position 14.0mm mated height	84530 Plug	84535 Receptacle
4.1.11	240 Position 4.0mm mated height	74213 Plug	74217 Receptacle

	TYPE	PRODUCT SPECIFICATION		NUMBER	GS-12-100			
	TITLE	MEG-Array™ 81, 100, 200, 240, 300, 400 & 528 Positions			PAGE	2 of 13	REVISION	R
				AUTHORIZED BY	D. Horchler		DATE	14 Oct 2013
				CLASSIFICATION	UNRESTRICTED			

4.1.12	240 Position 6.0mm mated height	74213 Plug	55755 Receptacle
4.1.13	300 Position 4.0mm mated height	84500 Plug	84501 Receptacle
4.1.14	300 Position 5.50mm mated height	84500 Plug	84502 Receptacle
4.1.15	300 Position 8.0mm mated height	84500 Plug	84553 Receptacle
4.1.16	300 Position 10.0mm mated height	84578 Plug	84501 Receptacle
4.1.17	300 Position 11.5mm mated height	84578 Plug	84502 Receptacle
4.1.18	300 Position 14.0mm mated height	84578 Plug	84553 Receptacle
4.1.19	320 Position 4.0mm mated height	10123981 Plug	10123982 Receptacle
4.1.20	400 Position 4.0mm mated height	84740 Plug	74221 Receptacle
4.1.21	400 Position 6.0mm mated height	84740 Plug	74388 Receptacle
4.1.22	400 Position 8.0mm mated height	84740 Plug	74390 Receptacle
4.1.23	400 Position 10.0mm mated height	84520 Plug	74221 Receptacle
4.1.24	400 Position 12.0mm mated height	84520 Plug	74388 Receptacle
4.1.25	400 Position 14.0mm mated height	84520 Plug	74390 Receptacle
4.1.26	528 Position 6.0mm mated height	10022671 Plug	10026846 Receptacle
4.1.27	Application Spec GS-20-033		

4.2 OTHER STANDARDS AND SPECIFICATIONS

- 4.2.1 UL-94: Flammability
- 4.2.2 EIA 364: Electrical Connector/Socket Test Procedures Including Environmental Classifications
- 4.2.3 ASTM B122: Copper-Nickel-Tin Alloy
- 4.2.4 ASTM B194: Beryllium Copper Alloy
- 4.2.5 ASTM D5138: Std Specification for Liquid Crystal Polymers
- 4.2.6 ANSI/J-STD-005: Requirements for Soldering Pastes
- 4.2.7 ANSI/J-STD-004: Requirements for Soldering Fluxes
- 4.2.8 IEC 68-2-60 Ke: Flowing mixed gas Corrosion Test
- 4.2.9 ANSI-J-002: Solderability Tests for Component Leads, Terminations, Lugs, Terminals & Wires (paragraph 3.4.2 Steam Aging)
- 4.2.10 EIA-638 - Surface Mount Solderability Test
- 4.2.12 Telcordia GR-1217-Core

	TYPE PRODUCT SPECIFICATION	NUMBER GS-12-100	
TITLE MEG-Array™ 81, 100, 200, 240, 300, 400 & 528 Positions		PAGE 3 of 13	REVISION R
		AUTHORIZED BY D. Horchler	DATE 14 Oct 2013
CLASSIFICATION UNRESTRICTED			

4.3 FCI SPECIFICATIONS

- 4.3.1 GS-15-0111: Nickel Plating
- 4.3.2 GS-15-012: Gold Plating
- 4.3.3 GES-14-455: Packaging of MEG-Array Product
- 4.3.4 BUS-19-124: Solderball to Terminal Tensile Test Procedure
- 4.3.5 BUS-19-125; MEG-Array Conn. 3 Point Bend Test Procedure
- 4.3.11 GS-18-015: Product Quality Plan
- 4.3.12 BUS-03-601: Current Rating

4.4 FCI LAB REPORTS - SUPPORTING DATA

- 4.4.1 EL-97-12-057: MEG Array Connector Qualification
- 4.4.3 EL-98-03-007A: 400 Pos. MEG Array Recept. Development Testing
- 4.4.4 EL-98-02-072: 3.4mm 240 Pos Recept. Durability & Hi Temp Life
- 4.4.5 EL-98-02-102: 4.0mm 400 Pos Recept. 3-Point Bend
- 4.4.6 EL-98-04-031^{CR} : 4.0mm 240 Pos Temp Cycle
- 4.4.7 EL-98-05-079: 240, 4.0mm Zipper Mating Forces
- 4.4.8 EL-98-12-069: 4.0mm, 400 Position Temp Cycling
- 4.4.9 EL-2003-10-09: Mating/Unmating Forces of 80, 81, 100 & 528 Positions
- 4.4.10 EL-2004-01-003C Lead Free BGA Temperature cycling
- 4.4.11 EL2012-03-007 Qualification of GXT Plating on MEG-Array
- 4.4.12 EL2012-03-008 Qualification of GXT Plating on MEG-Array

5.0 REQUIREMENTS

- 5.1 QUALIFICATION Connectors furnished under this specification shall be products that are capable of meeting the qualification test requirements specified herein.
- 5.2 MATERIAL The material for each part shall be as specified herein, or equivalent. Substitute material shall meet the performance requirements of this specification.
 - 5.2.1 Receptacle Terminal. The base material shall be beryllium copper alloy strip.
 - 5.2.2 Plug Terminal. The base material shall be copper-nickel-tin alloy strip.
 - 5.2.3 Plug and Receptacle Insulator Housing. The insulators shall be molded of liquid crystal polymer that is rated 94V-0 or better in accordance with UL-94.

	TYPE	PRODUCT SPECIFICATION		NUMBER	GS-12-100			
	TITLE	MEG-Array™ 81, 100, 200, 240, 300, 400 & 528 Positions			PAGE	4 of 13	REVISION	R
				AUTHORIZED BY	D. Horchler		DATE	14 Oct 2013
				CLASSIFICATION	UNRESTRICTED			

5.2.4 Solder Balls. Solder alloy 63 Tin/37 Lead or Lead Free 95.5Sn/4Ag/.5Cu

5.2.5 Solder Paste. Modified low resin content, no clean, with 63SN/37PB solder or Lead Free 95.5Sn/4Ag/.5Cu solder.

5.3 FINISH The plug and receptacle terminals have several plating options including Au and GXT over Ni and in various thicknesses from 0.4 µm min. to 1.27µm. See table paragraphs 8.4 and 8.5 for correlation of plating thicknesses to test performances.

5.4 DESIGN AND CONSTRUCTION. The connector shall be a multi-piece assembly having an array of contacts with solder balls attached, for installation on surface mount printed wiring boards or flexible circuits.

5.4.1 Mating. The connector shall be capable of mating and unmating manually without the use of special tools.

6.0 Electrical Characteristics

6.1 Contact Resistance, Low Level (LLCR) - The initial low level contact resistance shall not exceed (See List) milliohms, with a max.10 milliohms change after environmental exposure, when measured in accordance with EIA 364-23. The following details shall apply:

a) Initial Resistance for each mated height:

Mated Height	Initial LLCR
3.4mm	20mΩ
4.0mm	20mΩ
5.5mm	22mΩ
6.0mm	23mΩ
8.0mm	25mΩ
10.0mm	30mΩ
12.0mm	33mΩ
14.0mm	37mΩ

b) Method of Connection: Attach current and voltage leads as shown in Figure.

c) Test Voltage: 20 millivolts DC max open circuit

d) Test Current: Not to exceed 100 milliamperes.

6.2 Insulation Resistance – The insulation resistance of mated connectors shall not be less than 1000 megohms (1000 megohms after environmental exposure) when measured in accordance with EIA 364-21. The following details shall apply:

a) Test Voltage – 200 volts DC.

b) Electrification Time – 2 minutes, unless otherwise specified.

c) Points of Measurement – Between adjacent and opposing contacts.

	TYPE	NUMBER	
	PRODUCT SPECIFICATION	GS-12-100	
TITLE	MEG-Array™ 81, 100, 200, 240, 300, 400 & 528 Positions	PAGE	REVISION
		5 of 13	R
	AUTHORIZED BY	DATE	CLASSIFICATION
D. Horchler	14 Oct 2013	UNRESTRICTED	

6.3 Dielectric Withstanding Voltage – There shall be no evidence of arc-over, insulation breakdown, or excessive leakage current (> 1 milliamp) when mated connectors are tested in accordance with EIA 364-20. The following details shall apply:

- a) Test Voltage – 200 volts (DC RMS or AC, 60Hz).
- b) Test Duration – 60 seconds.
- c) Test Condition – 1 (760 Torr – sea level).
- d) Points of Measurement – Between adjacent and opposing contacts.

6.4 Current Rating – The temperature rise above ambient shall not exceed 30 °C at any point in the system when all contacts are powered at 0.45 ampere(s) or one contact is powered at 2.0 amperes. The following details shall apply:

- a) Ambient Conditions – Still air at 25 °C.
- b) Reference – BUS-03-601.
- c) A plug and receptacle were soldered to 38mm x 82 mm single sided board with solid layer of 3 oz. Copper. Power applied to connectors through wires screwed to corner of boards. Thermocouple located in center of connectors. See Figure 2.

FIGURE 1

Termination Resistance Measurement Points

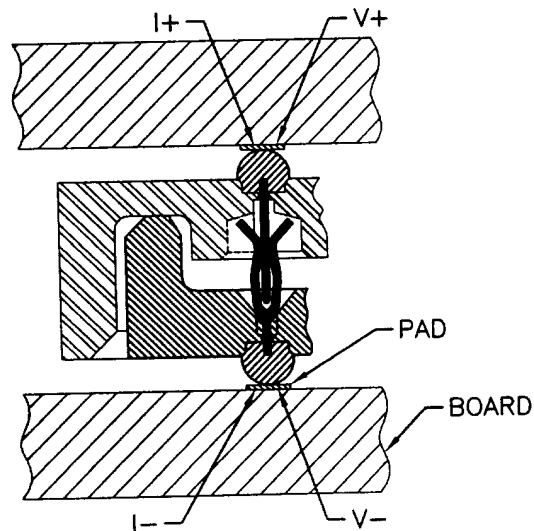

Note: If ambient temperature varies by more than 4° between measurements, all values shall be corrected to a standard ambient temperature.

FIGURE 2
Maximum Current Set-up

	TYPE	NUMBER
	PRODUCT SPECIFICATION	GS-12-100
TITLE	MEG-Array™ 81, 100, 200, 240, 300, 400 & 528 Positions	PAGE
		6 of 13
		REVISION
		R
		AUTHORIZED BY
		D. Horchler
		DATE
		14 Oct 2013
CLASSIFICATION		
UNRESTRICTED		

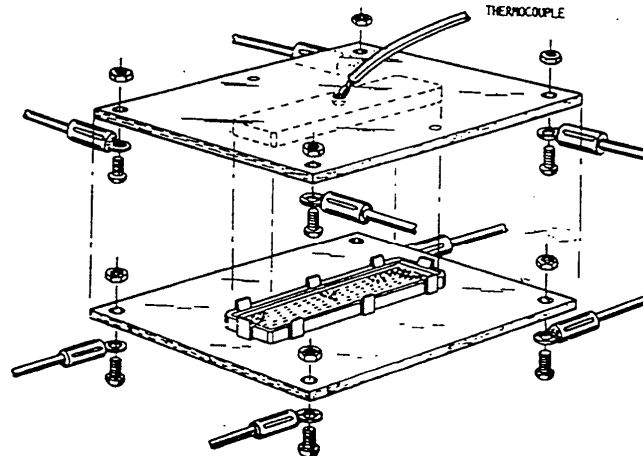

7.0 MECHANICAL CHARACTERISTICS

7.1 Mating/Unmating Force – Both plug and receptacle shall be soldered onto boards and the boards held in place by adequate fixturing to prevent cocking or misalignment, and shall be fully mated. Measurements are recorded for 3 mate/unmate cycles. Connectors are mated first on one end then the other end (zippered). See Figure 4

- a) Cross Head Speed – 5mm per minute.
- b) Lubrication – None

7.1.1 Total Mating Force

The max total mating force for each size shall be:								
Size	81 position	100 position	200 position	240 position	300 position	320 position	400 position	528 position
Force	7 kg*	14.5kg*	9kg*	8kg	12kg	13kg	14kg	20.5kg

7.1.2 Total Withdrawal Force

The max. withdrawal force shall be:								
Size	81 position	100 position	200 position	240 position	300 position	320 position	400 position	528 position
Force	3.5kg*	7.3kg*	6kg*	8kg	9.8kg	10kg	8kg	9kg

*Due to size of connector system, the zipper method was not used. All pins were mated and unmated at the same time.

7.2 Solderball Pull Strength – The solderball pull strength in “Z” axis shall not be less than 1000gms per contact when tested in accordance with BUS-19-124. Connectors are not soldered onto board. The housing is held in a fixture while each terminal is gripped in a vise and pulled vertically out of the housing. The terminal is stripped out of the ball, leaving the ball on the housing bottom.

	TYPE PRODUCT SPECIFICATION	NUMBER GS-12-100	
TITLE MEG-Array™ 81, 100, 200, 240, 300, 400 & 528 Positions		PAGE 7 of 13	REVISION R
		AUTHORIZED BY D. Horchler	DATE 14 Oct 2013
CLASSIFICATION UNRESTRICTED			

- 7.3 3-Point Bend – The connectors are soldered onto FR-4 bd. With pad geometry and footprint per FCI Customer drawing and Application Note 950554-002. The board is fixtured and bowed 20 mils/inch of board support distance (see Figure 3). Dye penetrant is applied to solder joints and dried. Conn. Is pried off board and solder joints are visually inspected for cracks that occurred during bending. Per BUS-19-125 3-Point Bend Procedure.

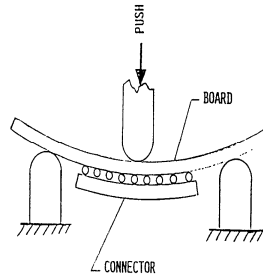



FIGURE 3 – 3-Point Bend Test

	TYPE PRODUCT SPECIFICATION	NUMBER GS-12-100	
TITLE MEG-Array™ 81, 100, 200, 240, 300, 400 & 528 Positions		PAGE 8 of 13	REVISION R
		AUTHORIZED BY D. Horchler	DATE 14 Oct 2013
CLASSIFICATION UNRESTRICTED			

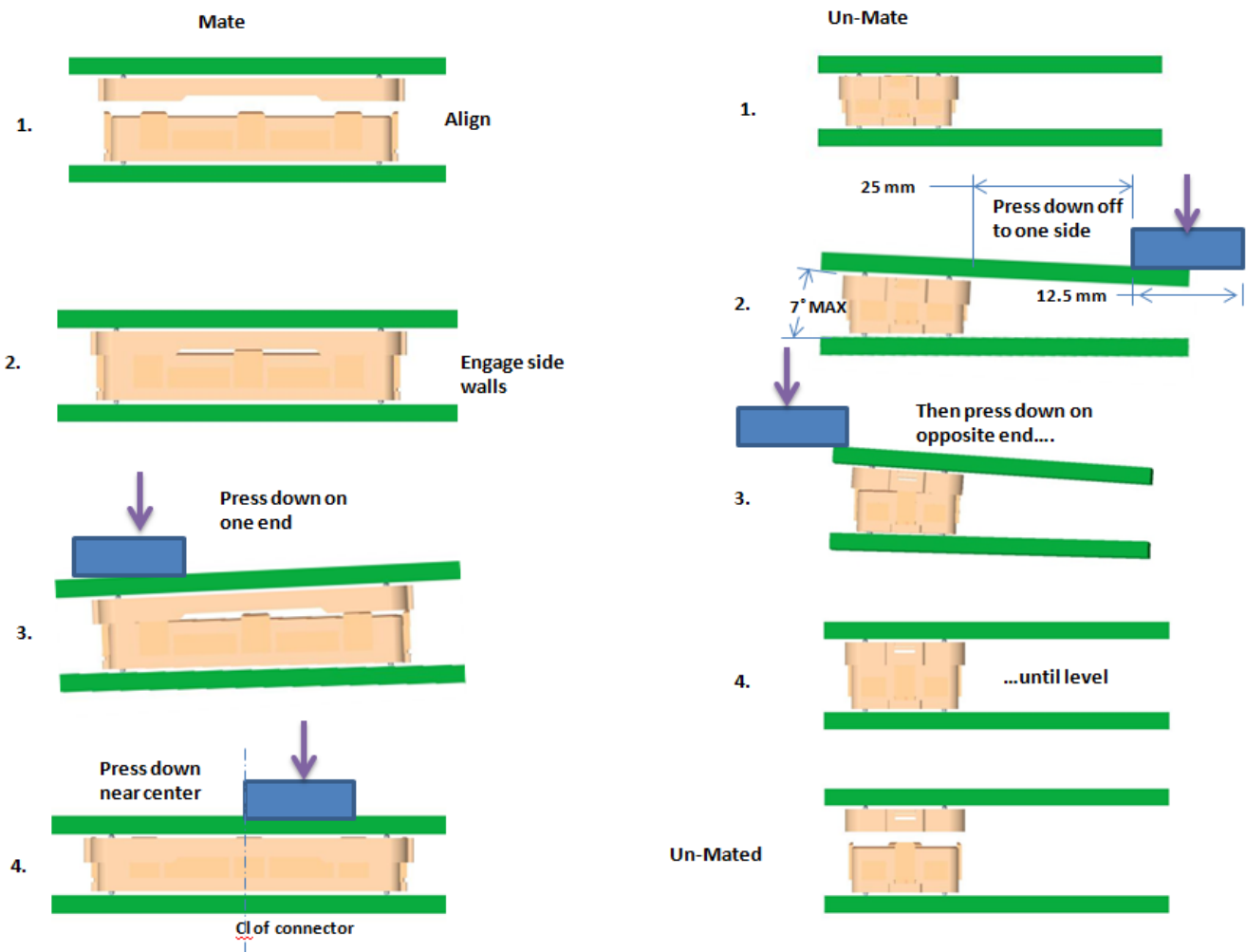



FIGURE 4

8.0 ENVIRONMENTAL CONDITIONS

After exposure to the following environmental conditions in accordance with the specified test procedure and/or details, the product shall show no physical damage and shall meet the electrical and mechanical requirements per sections 6.0 and 7.0 as specified in the Table 1A and 1B test sequences. Unless specified otherwise, assemblies shall be mated during exposure.

- 8.1a Temperature Cycling – At increments of 300 temperature cycles, contact resistance shall pass the requirements of Paragraph 6.1. Optionally, samples may be wired in series, with less than 100% increase in total resistance from initial value (recorded at hot temperature).

	TYPE	PRODUCT SPECIFICATION		NUMBER	GS-12-100			
	TITLE	MEG-Array™ 81, 100, 200, 240, 300, 400 & 528 Positions			PAGE	9 of 13	REVISION	R
				AUTHORIZED BY	D. Horchler		DATE	14 Oct 2013
				CLASSIFICATION	UNRESTRICTED			

- a) Number of Cycles – 1000
 - b) Temperature Range – Between -40 and 85 °C
 - c) Time for Each Cycle – 30 minutes (approx. 24 days to total)
- 8.1b Thermal Shock – EIA-364-32, Method A, Condition 1
- a) -55°C to + 85°C, 5 cycles
 - b) 30 min dwell time at each temperature extreme
 - c) <1 minute transfer rate
 - d) 1µsecond event detection
 - e) Mated condition
- 8.2a Humidity – EIA 364-31, Method II: Connectors shall be tested at accelerated humidity. Upon completion of exposure period, they shall be conditioned at room ambient for a period of four hours.
- a) Relative Humidity 95%
 - b) Temperature 40°C
 - c) Test Condition A (96 hours)
- 8.2b Moisture Resistance – EIA 364-31: Connectors shall be tested at accelerated humidity. Upon completion of exposure period, they shall be conditioned at room ambient for a period of four hours.
- a) Relative Humidity 95%
 - b) Temperature 25°C to 65°C
 - c) 500 hours
- 8.3 High Temperature Life – EIA 364-17.
- a) Test Temperature: 125 °C ± 5 °C
 - b) Test Duration – 500 hours
- 8.4 Durability – EIA 364-09

The connector halves shall be mated/unmated the following number of cycles according to the plating thickness being tested:

0.4µm (15 µ") thick Au or GXT	50 cycles (total)
0.8µm (30µ") thick Au or GXT	100 cycles (total)
1.27µm (50µ") thick Au or GXT	200 cycles (total)

After cycling, the contacts shall meet the requirements of paragraphs 6.1, 6.2 & 6.3 of this specification. The test shall be performed with plug & receptacle soldered to board.

8.5 Corrosive Atmosphere – IEC 68-2-60 Ke, EIA-364-65 Class IIa

Connectors shall be exposed to the listed mixed flowing gas environments according to the plating thickness as shown in the list below. Upon completion of the exposure, the contacts shall pass the requirements of paragraph 6.1 of this specification. The mated connectors shall not be disturbed during this test.

Using connectors mounted to the appropriate printed wiring board, they shall be exposed to a mixed gas atmosphere, to be placed in the test chamber of a sufficient volume to result in saturation of the test chamber.

- a) Relative humidity: 75%
- b) Exposure time: 96 hours
- c) Temperature: 40 ° ± 5 °C
- d) Plating thicknesses and corresponding Gas Exposure:

0.4µm (15µ") thick Au or GXT	IEC 68-2-60 Ke
	H2S: 3 ± 1 ppm

	TYPE	PRODUCT SPECIFICATION		NUMBER	GS-12-100	
	TITLE			PAGE	REVISION	
MEG-Array™ 81, 100, 200, 240, 300, 400 & 528 Positions			10 of 13	R		
			AUTHORIZED BY	DATE		
			D. Horchler	14 Oct 2013		
			CLASSIFICATION			
			UNRESTRICTED			

	S02: 10 ± 3 ppm 10 days mated
0.8µm (30µ") thick Au or GXT	EIA-65 Class IIa
	H2S: 10 ± 3 ppb
	SO2: 100 ± 20 ppb
	NO2: 200 ± 50 ppb
	CL2: 10 ± 3 ppb
	10 day mated
1.27µm (50µ") thick Au or GXT	EIA-364-65 Class IIa
	H2S: 10 ± 3 ppb
	SO2: 100 ± 20 ppb
	NO2: 200 ± 50 ppb
	CL2: 10 ± 3 ppb
	10 day unmated (plug) and 10 additional days mated

8.6 Solderability – EIA-638

Solder paste is deposited on a ceramic plate via stencil in the pattern per customer drawing. The connectors are steam aged and placed onto the solder paste print. The substrate is processed through a forced hot air convection oven with nitrogen blanket. The connectors are removed from the ceramic and solder balls inspected for bridging and wetting.

- a) Steam age 1 hour per ANSI-J-STD-002 (paragraph 3.4.2)
- b) Solder paste Alpha LR735 no clean
- c) Ceramic plate .9mm thick
- d) Temperature profile;
 - Eutectic: 230 ° C max., over 183 ° C, 45 -90 seconds, 60 – 120 ° C/min ramp until 110 ° to 130 ° C soak, soak 1.5 to 2.0 min.
 - Lead Free: 260 ° C max., over 218 ° C, 40 -70 seconds, 60 – 120 ° C/min ramp until 140 ° to 160 ° C soak, soak 1.5 to 2.0 min.

8.7 Disturbance – GR-1217-CORE (paragraph 9.1.3.3)

- a) Unmate contacts ≈ 0.1mm then re-mate

8.8 Mechanical Shock – EIA-364-27

- a) Condition H
- b) 3 shocks in each direction (18 total)

8.9 Vibration – EIA-364-28

- a) Condition II
- b) 8 hours

8.10 Dust – EIA-364-91

- a) Both plugs and receptacles un-mated
- b) Dust Composite #1
- c) For 1 hour

	TYPE PRODUCT SPECIFICATION	NUMBER GS-12-100	
TITLE MEG-Array™ 81, 100, 200, 240, 300, 400 & 528 Positions		PAGE 11 of 13	REVISION R
		AUTHORIZED BY D. Horchler	DATE 14 Oct 2013
CLASSIFICATION UNRESTRICTED			

9.0 QUALITY ASSURANCE PROVISIONS

9.1 Equipment Calibration

All test equipment and inspection facilities used in the performance of any test shall be maintained in a calibration system in accordance with ANSI/NCSL Z-540-1

9.2 Inspection Conditions

Unless otherwise specified herein, all inspections shall be performed under the following ambient conditions:

- a) Temperature: $25 \pm 5^\circ \text{C}$.
- b) Barometric pressure: Local ambient

	TYPE	NUMBER
	PRODUCT SPECIFICATION	GS-12-100
TITLE	PAGE	REVISION
MEG-Array™ 81, 100, 200, 240, 300, 400 & 528 Positions	12 of 13	R
	AUTHORIZED BY	DATE
	D. Horchler	14 Oct 2013
	CLASSIFICATION	
	UNRESTRICTED	

TABLE 1A – Qualification Testing for *0.4μm (15μ") and 0.8μm (30μ")* Thick Plating

TEST	PA.	Test Groups								
		1	2	3	4	5	6	7	8	9
Examination of Product	5.4	1 9	1 5	1 7	1 7	1 3	1 3	1 3	1 3	1 3
Contact Resistance Low Level	6.1	3 5 8	2 4		2 5					
Insulation Resistance	6.2			2 5						
Dielectric Withstanding Voltage	6.3			3 6						
Current Rating	6.4					2				
Mating/Unmating Force	7.1	2 6			3 6					
Solderball Pull Strength	7.2							2		
3-Point Bend	7.3									2
Temperature Cycling	8.1a						2			
Humidity	8.2a		3	4						
Hi Temperature Life	8.3				4					
Durability	8.4	4								
Corrosive Atmosphere	8.5	7								
Solderability	8.6							2		
Qty. Connectors/Group		3	3	3	3	1	30	3	3	3



	TYPE	PRODUCT SPECIFICATION		NUMBER	GS-12-100			
	TITLE	MEG-Array™ 81, 100, 200, 240, 300, 400 & 528 Positions			PAGE	13 of 13	REVISION	R
				AUTHORIZED BY	D. Horchler		DATE	14 Oct 2013
				CLASSIFICATION	UNRESTRICTED			

Table 1B – Qualification Testing for **1.27µm (50µ")** Plated Samples

TEST	PA.	Test Groups			
		2	3	4	5
		Test Sequence			
Examination of Product	5.4	1 11	1 9	1 13	1 14
Contact Resistance Low Level	6.1	3 5 8 10	4 6	2 4 6 8 10 12	3 7 9 11 13
Mating force	7.1	2	2 7		2
Un-mating force	7.1		3 8		4
Hi Temperature Life	8.3		5		
Durability (1/2 of total per paragraph 8.4 at each occurrence)	8.4	6		3 11	5 12
Corrosive Atmosphere unmated	8.5			5	
Corrosive Atmosphere mated	8.5			7	
Thermal Shock	8.1b	4			
Dust	8.10	7			6
Moisture Resistance - Humidity	8.2b	9			
Interface Disturbance	8.7			9	
Vibration	8.9				8
Mechanical shock	8.8				10
	5	5	5	5	5
Qty. Connectors/Group					

	TYPE	PRODUCT SPECIFICATION		NUMBER	GS-12-100			
	TITLE	MEG-Array™ 81, 100, 200, 240, 300, 400 & 528 Positions			PAGE	14 of 13	REVISION	R
				AUTHORIZED BY	D. Horchler		DATE	14 Oct 2013
				CLASSIFICATION	UNRESTRICTED			

REVISION RECORD

REV	PAGE	DESCRIPTION	EC #	DATE
1	All	Preliminary	V70712	04/21/97
2	ALL	Add dwg. Numbers, ref. Berg specs., add cleanliness, add Figures 2 & 3, and 7.2 & 7.3 and renumber	V71445	10/06/97
3	1-12	Update 4.1.1,4.1.2 & 4.1.3. Change 4.3.7,4.3.9,6.1,6.4, 7.1.1,7.1.2,7.3,8.1,8.5,8.6,9.1& 9.2	V80007	01/06/98
4	All	Delete 4.1.1,4.5.1. Change 4.1.2,4.1.3,4.5.2,&4.5.3.	V80262	03/17/98
5	3,5,6,8,9	Pg. 3, 6.1 a change 12 to 20, 16 to 25. Pg. 5 change 6.8.b ,change 75% to 7.5. Pg. 8 , 8.3 b change 240 to 500 hours. 6.9 add test in process. Add (d) to 8.1.	V81012	07/09/98
6	9	8.0 change b) from -25 and 100 to -40 and 85.	V81066	09/22/98
A	All	New Release	V90413	03/31/99
B	ALL	Revised format to be consistent with GS-01-001, and change BERG, Dupont, etc. references to FCI. Change document number prefix from GES to GS.	V01949	08/16/00
C	ALL	Add Products	V10218	3/12//01
D	ALL	Add Products	V21506	4/02/03
E	ALL	Add Products	V03-1179	10/27/03
F	3	Add Inductance Simulation Values	V03-1244	11/19/03
G	All	Add Lead Free BGA information	V04-0883	9/17/04
H	All	Change logo	V06-0539	6/2/06
J	All	Removed 80 Position information and add 200 position mating and un-mating force information	V06-0858	8/28/06
K	Page 5	Section 6.1 LLCR for 10, 12, 14mm	V09-0562	12/04/09
L	3	Sections 4.3.1 and 4.3.2 updated	V-007700	11/2/2011
M	ALL	Added GXT test performance results	V-011876	6/07/2012
N	3, 12, 13	Remove reference to EL-97-08-085, correct mistakes on Test group tables	V-13671	12/12/2012
P	2, 6, 9	Added 320 pos size, increased temp from 105° to 125°	V-15698	8/29/13
R	10,12	corrected .30u" and .15u" to 30u" and 15u"	V-16050-1	10/14/13