

NUMBER <b>GS-12-003</b>	TYPE <b>PRODUCT SPECIFICATION</b>		
TITLE <b>Latch &amp; Lock</b>		PAGE 1 of 13	REVISION F
		AUTHORIZED BY C. Martinez	DATE 16 April 08
		CLASSIFICATION <b>UNRESTRICTED</b>	

**1.0 OBJECTIVE**

This specification defines the performance, test, quality, and reliability requirements of the Latch & Lock as well as Lead Free product that meets the requirement of the European Union Directives of Restriction for Hazardous Substances (Directive 2002/95/EC).

**2.0 SCOPE**

This specification is applicable to the termination characteristics of the Latch & Lock family of products which provides a signal to signal and shield to ground termination system between a round cable and printed circuit board.

**3.0 GENERAL**

This document is composed of the following sections:

<u>Paragraph</u>	<u>Title</u>
1.0	OBJECTIVE
2.0	SCOPE
3.0	GENERAL
4.0	APPLICABLE DOCUMENTS
5.1	REQUIREMENTS
5.2	Qualification
5.3	Material
5.4	Finish
5.5	Design and Construction
6.0	ELECTRICAL CHARACTERISTICS
7.0	MECHANICAL CHARACTERISTICS
8.0	ENVIRONMENTAL CONDITIONS
9.1	QUALITY ASSURANCE PROVISIONS
9.2	Equipment Calibration
9.3	Inspection Conditions
9.4	Sample Quantity And Description
9.5	Qualification Testing
9.6	Requalification Testing

NUMBER <b>GS-12-003</b>	TYPE <b>PRODUCT SPECIFICATION</b>		
TITLE <b>Latch &amp; Lock</b>		PAGE 2 of 13	REVISION F
		AUTHORIZED BY C. Martinez	DATE 16 April 08
		CLASSIFICATION <b>UNRESTRICTED</b>	

#### 4.0 APPLICABLE DOCUMENTS

##### 4.1 Specifications

- 4.1.1 Engineering drawings
- 4.1.2 QAP
- 4.1.3 Process drawings

##### 4.2 Military Standards

- 4.2.1 MIL-STD-202F: Test methods for electronic and electrical component parts
- 4.2.2 MIL-M-20693: Glass filled nylon
- 4.2.3 MIL-G-45204: Gold plating (electro-deposit)
- 4.2.4 MIL-P-81728A: Sn-Pb plating
- 4.2.5 MIL-STD-1344A: Test methods for electrical connectors

##### 4.3 Federal Specifications

- 4.3.1 QQ-N-290: Nickel plating (electro-deposited).
- 4.3.2 QQ-N-533: Beryllium copper alloy strip.

##### 4.4 Other Standards and Specifications

- 4.4.1 UL-94: Flammability
- 4.4.2 ASTM B-122: Copper Nickel Alloy
- 4.4.3 ASTM B-36: Brass
- 4.4.4 ASTM B-103: Phosphor Bronze
- 4.4.5 ASTM B-159: Phosphor Bronze

##### 4.5 FCI Specifications

- 4.5.1 BUS-12-099: MINI PV Contact with spot of gold
- 4.5.2 BUS-12-050: BERGSTIK

##### 4.6 FCI Lab Reports - Supporting Data

- 4.6.1 EL-90-04-008: Test Group 4 and 5
- 4.6.2 EL-91-02-001: Test Groups 1 thru 3
- 4.6.3 EL-91-02-001A: Test Groups 1 thru 3
- 4.6.4 EL-88-01-033: Test Group 6
- 4.6.5 11/08/89 Memo: Test Group 7

NUMBER <b>GS-12-003</b>	TYPE <b>PRODUCT SPECIFICATION</b>		
TITLE <b>Latch &amp; Lock</b>		PAGE 3 of 13	REVISION F
		AUTHORIZED BY C. Martinez	DATE 16 April 08
		CLASSIFICATION <b>UNRESTRICTED</b>	

## 5.0 REQUIREMENTS

### 5.1 Qualification

Connectors furnished under this specification shall be capable of meeting the qualification test requirements specified herein.

### 5.2 Material

The material for each part shall be as specified herein or equivalent.

- 5.2.1 MINI PV Contact Body. Shall be 1/4 hard CuNi alloy, UNS C72500, in accordance with ASTM B-122.
- 5.2.2 MINI PV Contact Spring. Shall be 1/2 hard BeCu alloy, UNS C17200, in accordance with QQ-C-533, heat treated to full hard condition.
- 5.2.3 Outer Plug Housing and Header Plastic. Polycarbonate with UL 94 V-0 rating.
- 5.2.4 Shield Can. Shall be 1/2 hard brass in accordance with ASTM B-36.
- 5.2.5 Header Ground Terminal. Shall be 3/4 hard phosphor bronze alloy UNS-C51000 in accordance with ASTM B-103.
- 5.2.6 BERGSTIK Header Pins. Shall be phosphor bronze alloy UNS-C51000 in accordance with ASTM B-159.
- 5.2.7 MINI LATCH Housing. Polyphenylene Ether + Polystyrene (PPE+PS), with a UL rating of UL 94 V-0.

### 5.3 Finish

- 5.3.1 MINI PV Contact Body. Welded gold dot, 99.95% minimum purity Au.
- 5.3.2 MINI PV Contact Spring. Gold flash over 50 microinch nickel.
- 5.3.3 Shield Can. 60/40 tin lead or pure tin preplated, 200 microinch per P-SL/B200. and MIL-P-81728A.
- 5.3.4 Header Ground Terminal. 60/40 tin lead or pure tin preplated, 200 microinch per P-SL/B200 and MIL-P-81728A.
- 5.3.5 Header Pins. 3 microinch gold over 30 microinch palladium nickel over 50 microinch nickel.

NUMBER <b>GS-12-003</b>	TYPE <b>PRODUCT SPECIFICATION</b>		
TITLE <b>Latch &amp; Lock</b>		PAGE 4 of 13	REVISION F
		AUTHORIZED BY C. Martinez	DATE 16 April 08
		CLASSIFICATION <b>UNRESTRICTED</b>	

#### 5.4 Design And Construction

Connectors shall be of the design, construction, and physical dimensions specified on the applicable product drawing, and as shown in Figures 1 and 2. The plug uses FCI's Gold Dot MINI PV and MINI LATCH housing and incorporates a shield can to provide a ground path from the cable shield thru the header ground terminals to the PCB.

#### 5.5 Working Parameter

Voltage Rating: 250 V DC  
Current Rating: 2.5 A DC

### 6.0 **ELECTRICAL CHARACTERISTICS**

#### 6.1 Low Level Contact Resistance

The low level contact resistance shall not exceed 25 milliohms (35 milliohms after environmental exposure)(based on 26 AWG wire per Figure 4) when measured in accordance with MIL-STD-1344A, Method 3002.1. The following details shall apply:

- (a) Method of Connection - Attach current and voltage leads where shown in Figure 4.
- (b) Test Voltage - 20 millivolts DC max open circuit.
- (c) Test Current - Not to exceed 100 milliamps.

#### 6.2 Ground Terminal to Shield Contact Resistance

The ground terminal to shield contact resistance shall not exceed 8 milliohms (14 milliohms after environmental exposure) when measured in accordance with MIL-STD-1344A, Method 3002.1. The following details shall apply:

- (a) Method of Connection - Attach current and voltage leads where shown in Figure 4.
- (b) Test Voltage - 20 millivolts DC max open circuit.
- (c) Test Current - Not to exceed 100 milliamps.

#### 6.3 Shielding System Performance

Shielding system performance varies with frequency, and should be evaluated for each special application. The following table is representative of typical responses when measured using a swept frequency response method as described in BUS-03-107. The response from the cable is measured with a current probe sensor with the spectrum analyzer set to the "maximum hold" function. The difference in response from an unshielded reference cable assembly and the shielded cable under test is defined as the shielding performance of the connector.

NUMBER <b>GS-12-003</b>	TYPE <b>PRODUCT SPECIFICATION</b>		
TITLE <b>Latch &amp; Lock</b>		PAGE 5 of 13	REVISION F
		AUTHORIZED BY C. Martinez	DATE 16 April 08
		CLASSIFICATION <b>UNRESTRICTED</b>	

Figure 2 shows the physical appearance of the test samples. The cable is described as 6 conductors with an inner aluminized mylar shield, 95% coverage, and an outer tinned copper braid shield with 95% coverage, and one 26 AWG (7/34) tinned copper drain wire.

The table results represent the difference between three standard LATCH-N-LOK shield termination methods and a similar assembly with no electrical connection between the cable shield and connector shield can.

### Shielding Performance

	<u>Standard</u>	<u>Foil Wrap**</u>	<u>Full Can*</u>
At 50 MHz	27.13 dB	35.30 dB	36.40 dB
At 200 MHz	23.30 dB	31.50 dB	31.80 dB
Avg at 30-500 MHz	12.24 dB	21.24 dB	23.71 dB
Avg at 0-1000 MHz	11.10 dB	17.25 dB	18.10 dB

\* Tooled in 2X3 and 2X4 sizes, rear exit style only.

\*\* All sizes, rear exit only.

## 7.0 MECHANICAL CHARACTERISTICS

### 7.1 Mating/Unmating Force

The force to mate a 2X6 position LATCH-N-LOK plug assembly with a corresponding header assembly shall not exceed 13 pounds. The corresponding unmating force shall not be less than 3.5 pounds. The assemblies shall be mated with latches enabled and unmated with latches disabled at a cross head speed of 0.5 inches per minute. The respective maximum and minimum forces shall be the calculated average of the first three mating forces and first two unmating forces respectively.

### 7.2 Latch Durability

The plug latch cycle life shall exceed 4000 cycles when mated/unmated with a corresponding header assembly.

### 7.3 Latch Retention

The plug to header assembly latching mechanism shall withstand an axial load of 20 pounds minimum, when applied at a rate of 0.5 inches per minute and maintained for 5 seconds.

NUMBER <b>GS-12-003</b>	TYPE <b>PRODUCT SPECIFICATION</b>		
TITLE <b>Latch &amp; Lock</b>		PAGE 6 of 13	REVISION F
		AUTHORIZED BY C. Martinez	DATE 16 April 08
		CLASSIFICATION <b>UNRESTRICTED</b>	

## 8.0 **ENVIRONMENTAL CONDITIONS**

### 8.1 Thermal Shock

After exposure of the mated assemblies to the environment they shall meet the requirements for contact resistance per paragraph 6.1, and there shall be no evidence of cracking, crazing, or other physical damage. The test shall be in accordance with MIL-STD-202F, Method 107G, with the following details:

- (a) Test Condition - A (25, 1-hour cycles)
- (b) Temperature Range - -55C to +85C
- (c) Time at Each Temperature - 30 minutes
- (d) Transfer Time - 5 minutes, maximum

### 8.2 Humidity-Temperature Cycling

After exposure of the mated assemblies to the environment they shall meet the requirements for contact resistance per paragraph 6.1, and there shall be no evidence of cracking, crazing, or other physical damage. The test shall be conducted in accordance with MIL-STD-202F, Method 106F, with the following details:

- (a) Duration - 10 days (ten 24-hour cycles)
- (b) Omit step 7b

### 8.3 High Temperature Life

After exposure of the mated assemblies to the environment they shall meet the requirements for contact resistance per paragraph 6.1, and there shall be no evidence of cracking, crazing, or other physical damage. The test shall be conducted in accordance with MIL-STD-1344A, Method 1005.1, with the following details:

- (a) Test Condition - 80C +/- 2C exposure temperature
- (b) Test Duration - 1000 hours

### 8.4 Hydrogen Sulfide (H<sub>2</sub>S)

After exposure of the mated assemblies to the environment they shall meet the requirements for contact resistance per paragraph 6.1, and for ground terminal to shield contact resistance per paragraph 6.2. There shall be no evidence of cracking, crazing, or other physical damage. The test shall be conducted with the following details:

- (a) Concentration - 3 parts per million of H<sub>2</sub>S
- (b) Humidity - Moist (not defined)
- (c) Duration - 48 hours

NUMBER <b>GS-12-003</b>	TYPE <b>PRODUCT SPECIFICATION</b>		
TITLE <b>Latch &amp; Lock</b>		PAGE 7 of 13	REVISION F
		AUTHORIZED BY C. Martinez	DATE 16 April 08
		CLASSIFICATION <b>UNRESTRICTED</b>	

- (d) Temperature - 40C
- (e) Test Vessel - 9000 cc desiccator

8.5 Durability

After durability cycling the assemblies shall meet the requirements for contact resistance per paragraph 6.1, and there shall be no evidence of physical damage. The durability cycling shall be conducted with the latches disabled and the following details shall apply:

- (a) Number Cycles - 1000 cycles
- (b) Cycling Speed - 5 inches per minute

8.6 Vibration

During vibration there shall be no electrical discontinuities detected having a duration greater than 1 microsecond, and there shall be no evidence of physical or mechanical damage. The test shall be conducted in accordance with MIL-STD-202F, Method 204D with the following details:

- (a) Condition - B
- (b) Vibration Amplitude - 0.06" DA or +/-15G
- (c) Frequency Range - 10 to 2000 to 10 hertz
- (d) Sweep Time And Duration - 20 minutes per sweep, 4 hours along each of three orthogonal axes (12 hours total)

8.7 Mechanical Shock

During shock there shall be no electrical discontinuities detected having a duration greater than 1 microsecond, and there shall be no evidence of physical or mechanical damage. After shock the assemblies shall meet the requirements for contact resistance per paragraph 6.1. The test shall be conducted in accordance with MIL-STD-202F, Method 213B with the following details:

- (a) Condition - I (100G, 6 millisecond sawtooth)
- (b) Shocks - 3 shocks in both directions along each of 3 orthogonal axes (18 total)
- (c) Mounting - Rigidly mount mated assemblies

NUMBER <b>GS-12-003</b>	TYPE <b>PRODUCT SPECIFICATION</b>		
TITLE <b>Latch &amp; Lock</b>		PAGE 8 of 13	REVISION F
		AUTHORIZED BY C. Martinez	DATE 16 April 08
		CLASSIFICATION <b>UNRESTRICTED</b>	

**9.0 QUALITY ASSURANCE PROVISIONS**

9.1 Equipment Calibration

All test equipment and inspection facilities used in the performance of any test shall be maintained in a calibration system in accordance with MIL-C-45662 and ISO 9000.

9.2 Inspection Conditions

Unless otherwise specified herein, all inspections shall be performed under the following ambient conditions:

- (a) Temperature - 25C +/- 5C
- (b) Relative Humidity - 30% to 60%
- (c) Barometric Pressure - Local ambient

9.3 Sample Quantity And Description

Refer to Figures 1, 2 and 3 for sample descriptions. Sample quantities for the respective test groups shall consist of the following:

- Test Groups 1 thru 3 -Four (2X6 pos.) connector pairs
- Test Groups 4, 5 and 7 - Five connector pairs of each size
- Test Group 6 - Three (2X3 pos.) plug assemblies with six feet of shielded cable.

Note: Since the PV contacts are lubricated during manufacturing, no additional lubrication shall be applied before testing.

9.4 Qualification Testing

Qualification testing shall be performed on sample units produced with equipment and procedures normally used in production. The test sequence shall be as shown in Table 1.

9.5 Requalification Testing

If either of the following conditions occur, the product responsible engineer shall initiate requalification testing consisting of all or applicable parts of the Qualification Test Matrix, Table 1.

- (a) A significant design change is made to the existing product. A significant change shall include, but not be limited to, changes in contact material composition, contact material thickness, contact force, contact surface geometry, underlying material composition, underlying material thickness, insulator design, contact base material, or contact lubrication requirements.



NUMBER <b>GS-12-003</b>	TYPE <b>PRODUCT SPECIFICATION</b>		
TITLE <b>Latch &amp; Lock</b>		PAGE 9 of 13	REVISION F
		AUTHORIZED BY C. Martinez	DATE 16 April 08
		CLASSIFICATION <b>UNRESTRICTED</b>	

(b) A product failure occurs during production or end use requiring corrective action to be taken relative to the product design or manufacturing process.

**TABLE 1 - QUALIFICATION TESTING**

TEST	PARA	TEST GROUP						
		1	2	3	4	5	6	7
		TEST SEQUENCE						
Examination of Product	5.4	1	1	1	1	1	1	1
Contact Resistance	6.1	4	4	4				
Low Level		6	6	6				
		8	9	8				
		10	11	10				
		12		12				
Contact Resistance	6.2	13	12	13				
Ground Terminal to Shield								
Mating Force	7.1	2	2	2	2			
Unmating Force	7.1	3	3	3				
Latch Durability	7.2					2		
Latch Retention	7.3							2
Shielding Effectiveness	6.2						2	
Thermal Shock	8.1	5	5	5				
Humidity/Temperature	8.2	7	10	9				
Heat Age	8.3	9		11				
Hydrogen Sulfide (H <sub>2</sub> <sup>S</sup> )	8.4	11						
Durability	8.5			7				
Vibration	8.6		7					
Mechanical Shock	8.7		8					

NUMBER <b>GS-12-003</b>	TYPE <b>PRODUCT SPECIFICATION</b>		
TITLE <b>Latch &amp; Lock</b>		PAGE 10 of 13	REVISION F
		AUTHORIZED BY C. Martinez	DATE 16 April 08
		CLASSIFICATION <b>UNRESTRICTED</b>	

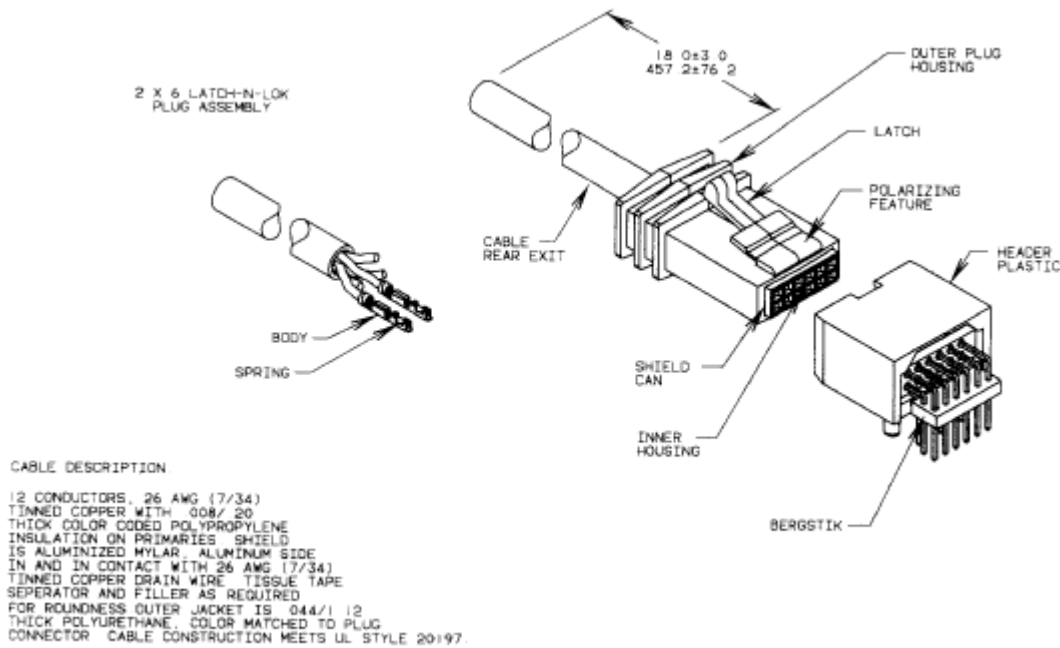

**TEST GROUPS 1, 2, AND 3**

**FIGURE 1**

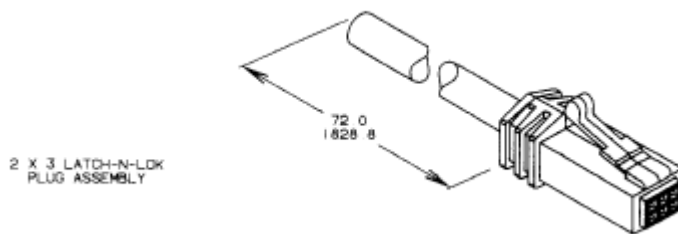

**TEST GROUP 6**

**FIGURE 2**

NUMBER <b>GS-12-003</b>	TYPE <b>PRODUCT SPECIFICATION</b>		
TITLE <b>Latch &amp; Lock</b>		PAGE 11 of 13	REVISION F
		AUTHORIZED BY C. Martinez	DATE 16 April 08
		CLASSIFICATION <b>UNRESTRICTED</b>	

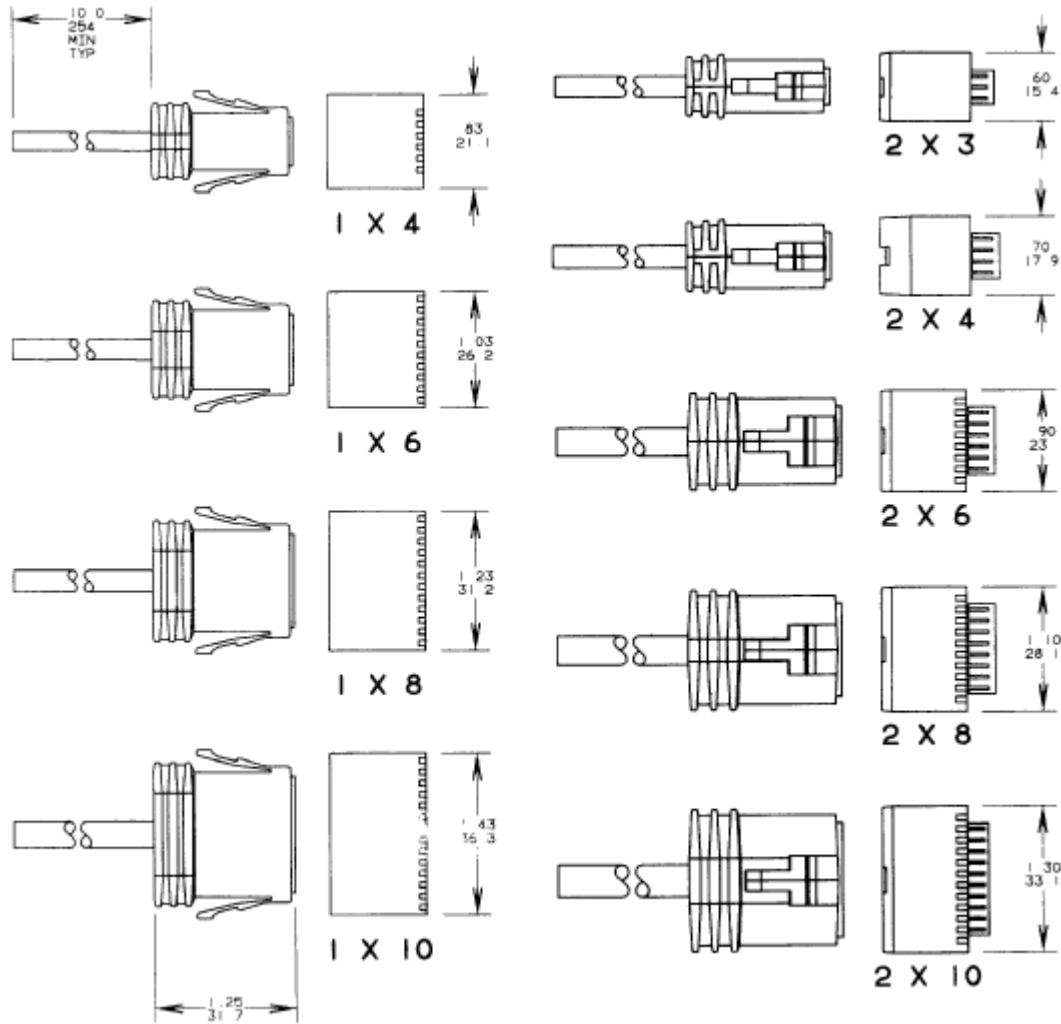

TEST GROUP 4, 5, AND 7

**FIGURE 3**

NUMBER <b>GS-12-003</b>	TYPE <b>PRODUCT SPECIFICATION</b>		
TITLE <b>Latch &amp; Lock</b>		PAGE 12 of 13	REVISION F
		AUTHORIZED BY C. Martinez	DATE 16 April 08
		CLASSIFICATION <b>UNRESTRICTED</b>	

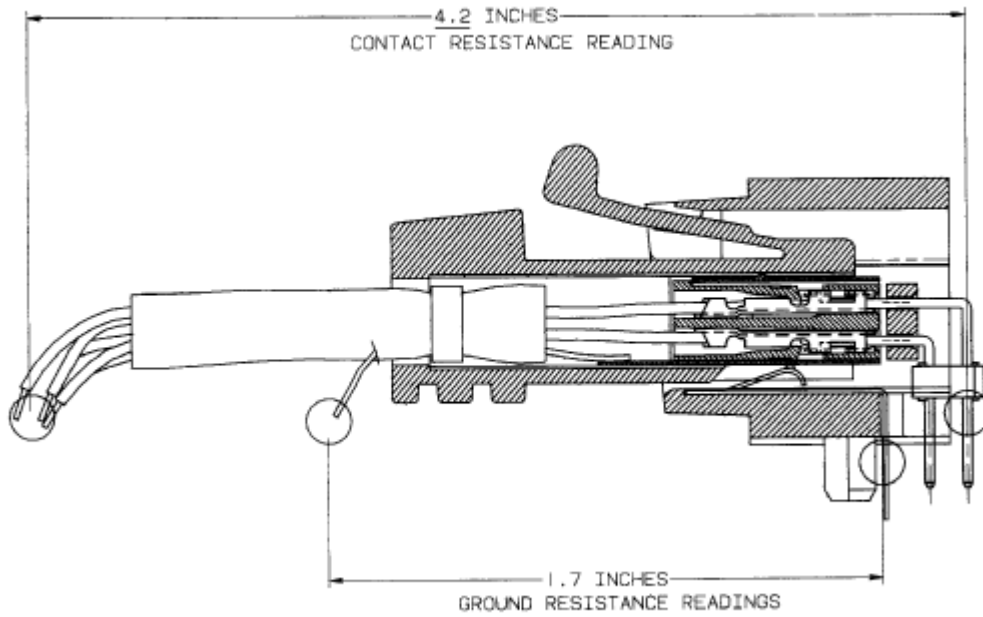

**FIGURE 4**

NUMBER <b>GS-12-003</b>	TYPE <b>PRODUCT SPECIFICATION</b>		
TITLE <b>Latch &amp; Lock</b>		PAGE 13 of 13	REVISION F
		AUTHORIZED BY C. Martinez	DATE 16 April 08
		CLASSIFICATION <b>UNRESTRICTED</b>	

**REVISION RECORD**

<u>REV</u>	<u>PAGE</u>		<u>EC #</u>	<u>DATE</u>
1	All			07/11/91
2	2, 3, 8			07/12/91
3	All			08/22/91
4	2, 3, 6, 10, 13			08/29/91
5	4, 7, 10, 13			09/06/91
A	All		V12547	09/09/91
B	3,4		V23120	09/24/92
C	All	Revised format to be consistent with GS-01-001, and change BERG, Dupont, etc. references to FCI. Change document number prefix from GES to GS.	V01949	08/15/00
D	All	Change Logo	M07-0357	08/09/2007
	1,3,4 6	Add Lead Free information MIL-STD-1344 was replaced by EIA-364		
E	2	Update FCI reference documentation	M08-0106	04/16/2008
	3	5.2.7 , 5.3.1 & 5.3.2 updated		
F	4	Add working parameter	ELX-N-25959	01/22/2017