	TYPE	PRODUCT SPECIFICATION		NUMBER	BUS-12-067	
	TITLE			PAGE	REVISION	
Crimp-to Wire, Mini-PV™ Receptacles and Mini-Latch Housings			1 of 16	K		
			AUTHORIZED BY	DATE		
			H.T. Brewbaker	31-May-06		
			CLASSIFICATION			
			UNRESTRICTED			

1.0 OBJECTIVE

This specification defines the performance, test, quality and reliability requirements of Crimp-to-Wire Mini-PV (TM) receptacles and Mini-Latch housings.

2.0 SCOPE

This specification is applicable to the termination characteristics of the Crimp-to-Wire Mini-PV (TM) receptacles and Mini-Latch housings which are designed for interconnection of discrete wires and 0.025 inch round or square pins.

These connectors provide only the receptacle half of the interconnection and are designed to mate with single or double rows of pins, free standing or in headers, on 0.100, 0.125, 0.150 or 0.156 inch centers.

3.0 GENERAL

This document is composed of the following sections:

<u>Paragraph</u>	<u>Title</u>
1.0	OBJECTIVE
2.0	SCOPE
3.0	GENERAL
4.0	APPLICABLE DOCUMENTS
5.0	REQUIREMENTS
5.1	Qualification
5.2	Material
5.3	Finish
5.4	Design and Construction
6.0	ELECTRICAL CHARACTERISTICS
7.0	MECHANICAL CHARACTERISTICS
8.0	ENVIRONMENTAL CONDITIONS
9.0	QUALITY ASSURANCE PROVISIONS
9.1	Equipment Calibration
9.2	Inspection Conditions
9.3	Sample Quantity and Description
9.4	Acceptance
9.5	Qualification Testing
9.6	Requalification Testing
TABLE VI	QUALIFICATION TEST MATRIX

3.1 Banned/Restricted Substances

All product where the part number ends in "LF" meet the European Union directives and other country regulations as described in GS-22-008. The part numbers that do not end in "LF" meet all regulations except for Pb in SnPb plating, if available. Tin plated "LF" product has 100% tin plating in the interface and has not been tested for whisker growth in all interconnect environments.

	TYPE	PRODUCT SPECIFICATION		NUMBER	BUS-12-067	
	TITLE			PAGE	REVISION	
Crimp-to Wire, Mini-PV™ Receptacles and Mini-Latch Housings			2 of 16	K		
			AUTHORIZED BY	DATE		
			H.T. Brewbaker	31-May-06		
			CLASSIFICATION			
			UNRESTRICTED			

3.2 Manufacturing Processability

This product is not designed to be exposed to manufacturing solder processes.

4.0 APPLICABLE DOCUMENTS

4.1 Specifications

- 4.1.1 Engineering drawings
- 4.1.2 Process drawings
- 4.1.3 MIL-G-45204: Electrodeposited Gold
- 4.1.4 MIL-W-16878: High Temperature Insulated Electrical Wire

4.2 Military Standards

- 4.2.1 MIL-STD-1344: Test Methods for Electrical Connectors
- 4.2.2 MIL-STD-202: Test Methods for Electronic and Electrical Component Parts.

4.3 Federal Specifications

- 4.3.1 QQ-N-290: Nickel Plating (Electrodeposited)
- 4.3.2 QQ-B-613: Leaded and Non-Leaded Brass

4.4 Other Standards and Specifications

- 4.4.1 UL94-V0: Flammability
- 4.4.2 ASTM B579: Electrodeposited Coatings of Tin-Lead Alloy
- 4.4.3 ASTM B122: Copper-Nickel-Tin Alloy, Copper-Nickel-Zinc Alloy (Nickel Silver), and Copper-Nickel Alloy Plate, Sheet, Strip and Rolled Bar
- 4.4.4 ASTM B-194: Copper-Beryllium Alloy Plate, Sheet, Strip and Rolled Bar
- 4.4.5 ANSI/ASQC M-1: American National Standard for Calibration Systems
- 4.4.6 BUS-03-404: FCI Test Specification for Normal Force Measurements
- 4.4.7 BUS-03-302: FCI Test Specification for Sulfide Vapor Test
- 4.4.8 TA-75: FCI Latch Housing Mini-PV Crimp/Application Data

5.0 REQUIREMENTS

5.1 Qualification

Terminals furnished under this specification shall be capable of meeting the qualification test requirements specified herein.

5.2 Material

The material for each component shall be as specified herein or equivalent.

- 5.2.1 Body. The contact body shall be Quarter-Hard Brass Alloy UNS C26000 in accordance with QQ-B-613 or Quarter-Hard CuNi Alloy UNS 72500 in accordance with ASTM B122.

	TYPE	PRODUCT SPECIFICATION		NUMBER	BUS-12-067
	TITLE			PAGE	REVISION
Crimp-to Wire, Mini-PV™ Receptacles and Mini-Latch Housings			3 of 16	K	
			AUTHORIZED BY	DATE	
			H.T. Brewbaker	31-May-06	
			CLASSIFICATION		
			UNRESTRICTED		

5.2.2 Spring. The contact spring shall be Half-Hard, Beryllium Copper Alloy UNS C17200 in accordance with ASTM B-194 heat treated to full hard condition.

5.2.3 Housing. The latch housings shall be of the material specified on the product drawings. Materials shall have a flame retardant rating of UL94-V0.

5.2.4 Polarizing Plug. The plug shall be of the material specified on the product drawings. Materials shall have a flame retardant rating of UL94-V0.

5.3 Finish

The finish for applicable components shall be as specified herein or equivalent.

5.3.1 Contact Body. As specified by the product drawings, the contact body shall be plated in the contact area with the specified gold plating thickness per MIL-G-45204, Type II, Grade C over 50 microinches nickel per QQ-N-290, Class 2, or shall be plated with tin-lead in accordance with ASTM B579. Lead free tin plating is also available, the material shall be hot dip tin coated with a thickness of 100-160 micro inches.

5.3.2 Spring. The contact spring shall be plated with a flash of gold per MIL-G-45204, Type II, Grade C over 50 microinches nickel per QQ-N-290, Class 2 or where specified on the product drawing with tin-lead in accordance with ASTM B579. Lead free tin plating is also available, plated per GS-46-001 (Confidential).

5.4 Design and Construction

Terminals and housings shall be of the design, construction and physical dimensions specified on the applicable product drawing.

These crimp-to-wire terminals are designed to be either individually mated with pins without a housing or inserted into a Mini-Latch or Rod Housing and connected to a header or bare pin field. They are designed to crimp to discrete stranded 18 to 36 AWG wire. Hand tools and bench mounted applicators are available for crimping terminals.

The terminals are available in a choice of spring thicknesses to provide several levels of contact normal force.

5.5 Polarization/Keying/Latching.

Polarization and /or keying of the connector is accomplished through the use of individual polarizing plugs inserted into selected contact positions. As an option, in some cases one or more housing positions can be molded closed. In either case, the polarized position is rendered non-functional. Special external polarization, keying and/or latching features are available depending on part number and specific requirements.

	TYPE	PRODUCT SPECIFICATION		NUMBER	BUS-12-067
	TITLE			PAGE	REVISION
Crimp-to Wire, Mini-PV™ Receptacles and Mini-Latch Housings			4 of 16	K	
			AUTHORIZED BY	DATE	
			H.T. Brewbaker	31-May-06	
			CLASSIFICATION		
			UNRESTRICTED		

6.0 Electrical Characteristics

- 6.1 Current Rating - The maximum current rating of the connector is dependent on wire size and housing/circuit geometry. Figure 1 shows typical graphs of the temperature rise as a function of current for various wire sizes. Figure 1A shows typical graphs of temperature rise as a function of current for various wire sizes as they were tested in a dense pack (2x36 position) housing. Figure 2 shows temperature rise profiles based on current applied. Charts for Figure 1 and 2 show test results of PV's that were tested in a single position housing except for 18 and 20 AWG. These are not recommended for use in a Mini Latch housing.
- 6.2 Contact Resistance, Low Level - After environmental testing, the change in contact resistance of the mated connector shall not exceed 2 milliohms when measured in accordance with MIL-STD-1344, Method 3002. The following details shall apply:
- Method of Connection - Attach current and voltage leads as shown in Figure 3
 - Test Voltage - 20 millivolts DC max open circuit.
 - Test Current - Not to exceed 100 milliamperes.
- 6.3 Crimp Resistance, Low Level - When properly crimped, the change in crimp resistance shall not exceed 1 milliohms for wire sizes 18-30 AWG. The change in crimp resistance for 32-36 AWG shall not exceed 2 milliohms. Crimp resistance shall be measured in accordance with MIL-STD-1344, Method 3002. The following details shall apply:
- Method of Connection - Attach current and voltage leads as shown in Figure 3A.
 - Test Voltage - 20 millivolts DC max open circuit.
 - Test Current - Not to exceed 100 milliamperes.
- 6.4 Insulation Resistance - The insulation resistance of unmated terminals, properly mounted in Mini-Latch housings, shall not be less than 10,000 megohms (5000 megohms after exposure to the humidity environment described below) when measured in accordance with MIL-STD-202, Method 302. The following details shall apply:
- Test Voltage - 500 volts DC
 - Electrification Time - 2 minutes
 - Points of Measurement - Between adjacent and opposing contacts.

	TYPE	PRODUCT SPECIFICATION		NUMBER	BUS-12-067	
	TITLE			PAGE	REVISION	
Crimp-to Wire, Mini-PV™ Receptacles and Mini-Latch Housings			5 of 16	K		
			AUTHORIZED BY	DATE		
			H.T. Brewbaker	31-May-06		
			CLASSIFICATION			
			UNRESTRICTED			

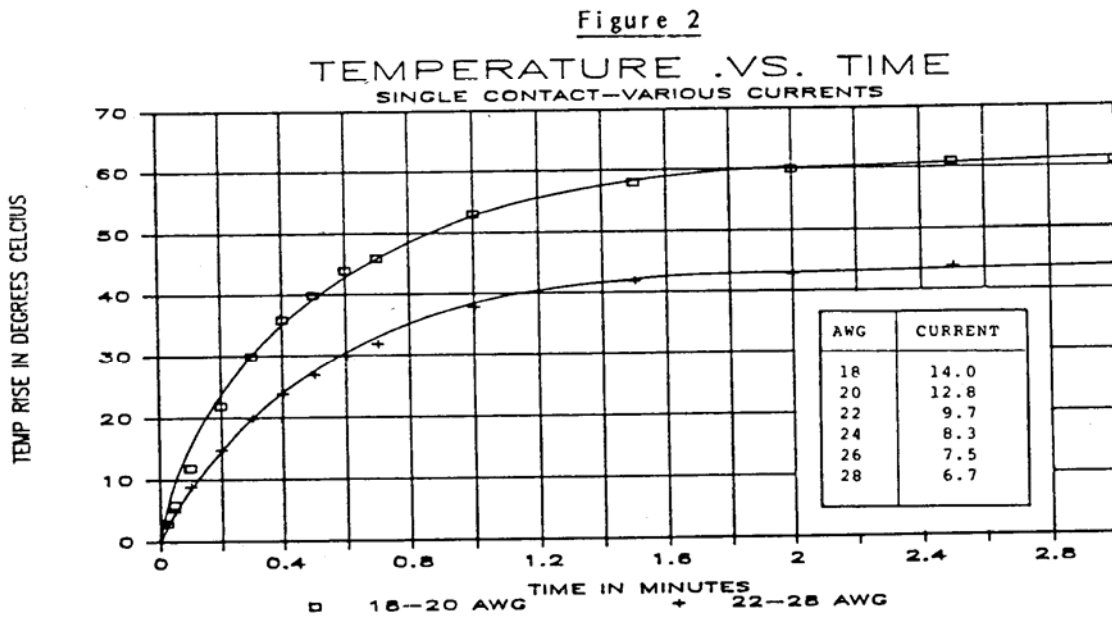
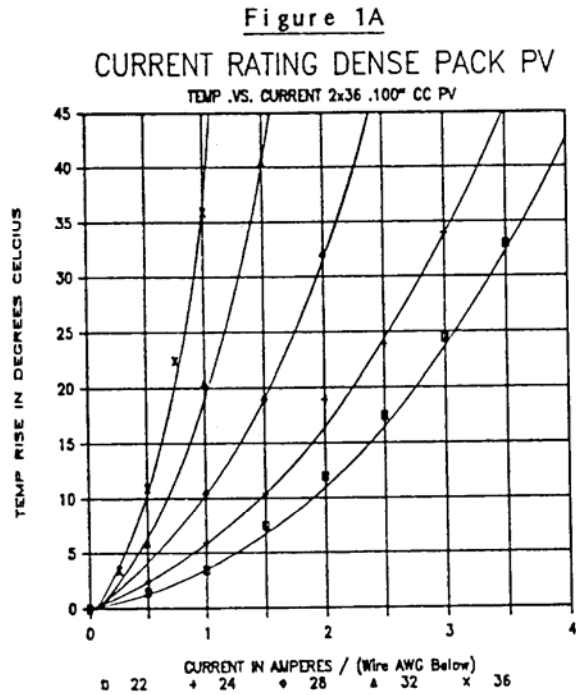
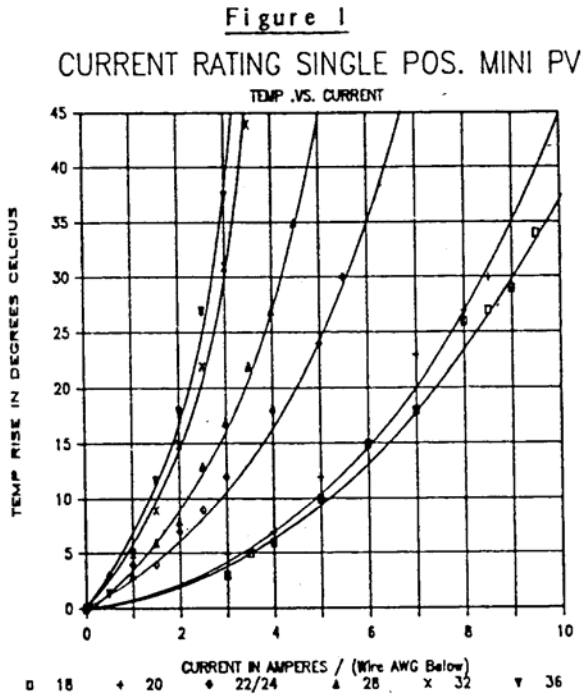



TYPE

PRODUCT SPECIFICATION

NUMBER

BUS-12-067

TITLE

Crimp-to Wire, Mini-PV™ Receptacles and Mini-Latch Housings

PAGE

6 of 16

REVISION

K

AUTHORIZED BY

H.T. Brewbaker

DATE

31-May-06

CLASSIFICATION

UNRESTRICTED

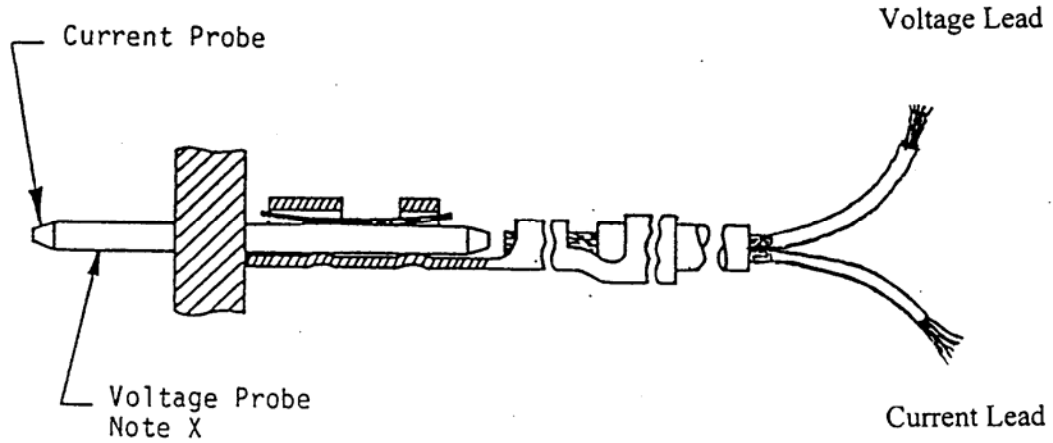

NOTE X: Probe to be within .070 of board.

FIGURE 3
CONTACT RESISTANCE

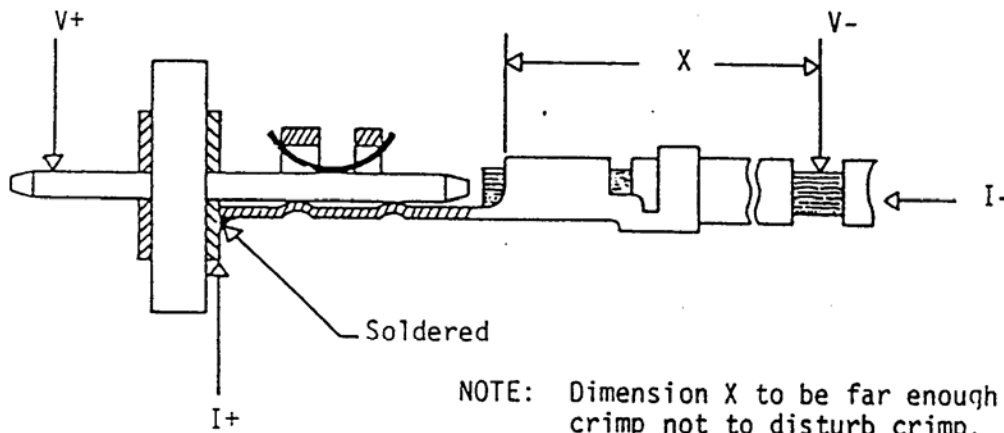

NOTE: Dimension X to be far enough away from crimp not to disturb crimp.

FIGURE 3A
CRIMP RESISTANCE

	TYPE	PRODUCT SPECIFICATION		NUMBER	BUS-12-067
	TITLE			PAGE	REVISION
Crimp-to Wire, Mini-PV™ Receptacles and Mini-Latch Housings			7 of 16	K	
			AUTHORIZED BY	DATE	
			H.T. Brewbaker	31-May-06	
			CLASSIFICATION		
			UNRESTRICTED		

6.5 Dielectric Withstanding Voltage - There shall be no evidence of arc-over, insulation breakdown, or excessive leakage current (> 1 milliampere) when the unmated connector is tested in accordance with MIL-STD-1344, Method 3003. The following details shall apply:

- a. Test Voltage - 1000 volts RMS, 60 Hz
- b. Test Duration - 60 seconds
- c. Test Condition - 1 (760 Torr - sea level)
- d. Points of Measurement - between adjacent and opposing contacts.

6.6 Capacitance - The capacitance between adjacent or opposing contacts in an unmated connector shall not exceed 0.5 picofarads when measured in accordance with MIL-STD-202, Method 305, at a frequency of 100 kilohertz.

7.0 Mechanical Characteristics

7.1 Contact Retention - Each individual contact shall withstand an axial load of 4.0 pounds applied to the terminating wire without dislodgement from the housing cavity.

7.2 Normal Force - The minimum contact normal forces shall be as shown in Table I when tested in accordance with FCI Test Specification BUS-03-404, by the Probe Method (par 3.2) at a deflection equivalent to a 0.024" gauge pin. This requirement must be met before and after environmental testing. (See Figure 4).

TABLE I - CONTACT NORMAL FORCE

<u>Spring Thickness (Mils)</u>	<u>Force (Grams)</u>
3.5	150
4.8	375
5.8	575
6.5	700

7.3 Total Mating Force - The total force to mate the connectors with an appropriately populated header consisting of properly configured 0.025 inch square pins (see Figure 6) shall be approximately the value shown in Table II, for the selected spring thickness, times the number of contacts.



TYPE

PRODUCT SPECIFICATION

NUMBER

BUS-12-067

TITLE

Crimp-to Wire, Mini-PV™ Receptacles and Mini-Latch Housings

PAGE

8 of 16

REVISION

K

AUTHORIZED BY

H.T. Brewbaker

DATE

31-May-06

CLASSIFICATION

UNRESTRICTED

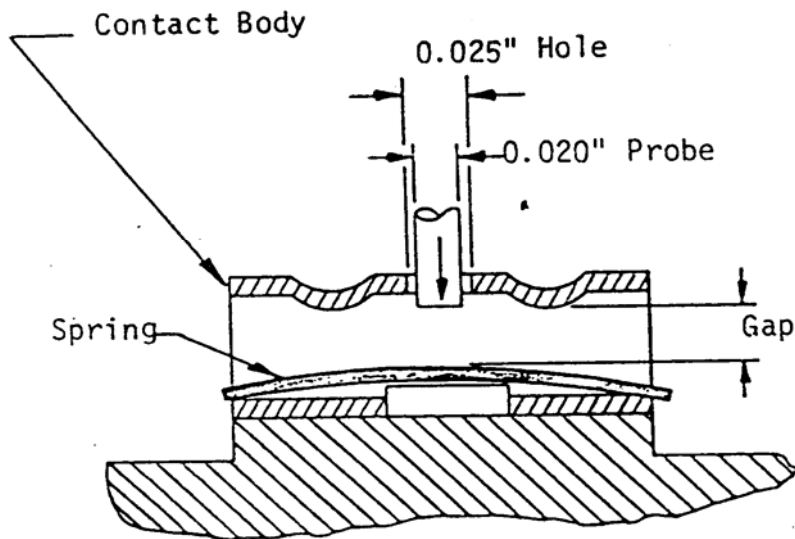
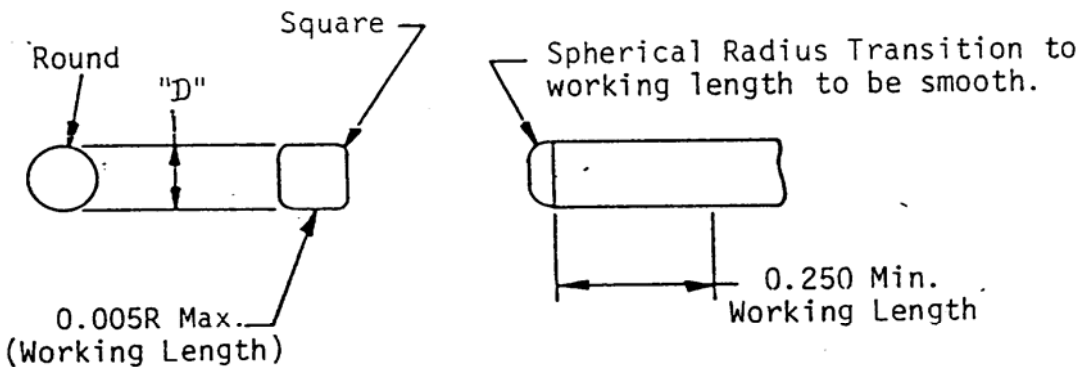

FIGURE 4 - NORMAL FORCE



"D" = .025 +/- .001 Square or Round

FIGURE 5 - PIN GAGES

	TYPE	PRODUCT SPECIFICATION		NUMBER	BUS-12-067			
	TITLE	Crimp-to Wire, Mini-PV™ Receptacles and Mini-Latch Housings			PAGE	9 of 16	REVISION	K
				AUTHORIZED BY	H.T. Brewbaker		DATE	31-May-06
				CLASSIFICATION	UNRESTRICTED			

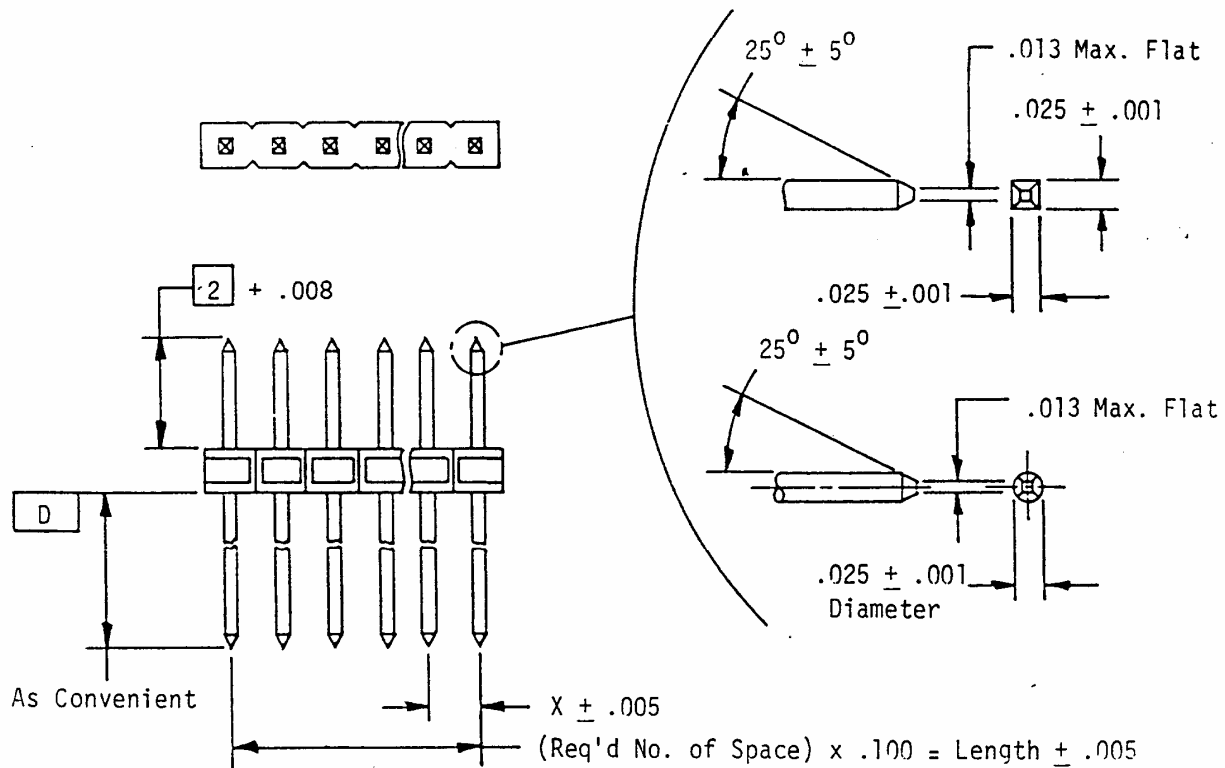

- 1 Measure at Datum -D- with part in restrained (flat condition).
- 2 Length to insure contact with PV™ terminal interface.
- 3 Plating: Equivalent to PV™ terminal

FIGURE 6 - MATING HEADER

	TYPE	PRODUCT SPECIFICATION		NUMBER	BUS-12-067	
	TITLE			PAGE	REVISION	
Crimp-to Wire, Mini-PV™ Receptacles and Mini-Latch Housings			10 of 16	K		
			AUTHORIZED BY	DATE		
			H.T. Brewbaker	31-May-06		
			CLASSIFICATION			
			UNRESTRICTED			

TABLE II - MATING FORCES

<u>Spring Thickness (Mils)</u>	<u>Force (Grams)</u>
3.5	150
4.8	300
5.8	525
6.5	725

- 7.4 Individual Contact Insertion Force - When measured using a maximum guage pin configured as shown in Figure 5, the typical individual contact insertion force shall not be greater than the value shown in Table III.
- 7.5 Individual Contact Withdrawal Force - After five insertions using a maximum guage pin configured as shown in Figure 5, the typical individual contact withdrawal force shall not be less than the value shown in Table III when measured using a minimum guage pin configured as shown in Figure 5.

TABLE III - CONTACT FORCES

<u>Spring Thickness (Mils)</u>	<u>Contact Force (Grams)</u>	
	<u>Insertion (Max)</u>	<u>Withdrawal (Min)</u>
3.5	240	45
4.8	450	75
5.8	700	130
6.5	1100	175

- 7.6 Durability - After 1000 mating/unmating cycles with 0.025 inch square pin standard Bergstik (R) Headers, , the 15 u" gold contact (or heavier gold plating) terminals shall be again mated and then subjected to a moist Hydrogen Sulfide atmosphere (approximately 3 ppm). After 48 hours of H₂S per BUS-03-302, the change in contact resistance shall not exceed 2 milliohms for any spring thickness.
- 7.7 Tensile Strength, Crimp - The force required to pull the properly crimped wire (per TA-75) from the terminal shall not be less than the value specified in Table IV when tested in accordance with MIL-STD-1344, Method 2003, at a cross-head parting speed of one inch per minute maximum.

TABLE IV - CRIMP TENSILE STRENGTH

<u>Wire Size, AWG</u>	<u>Strength, Lbs</u>	<u>Wire Size, AWG</u>	<u>Strength, Lbs</u>
18	32.0	28	5.0
20	28.0	30	2.5
22	16.0	32	1.5
24	11.0	34	1.0
26	6.5	36	0.5

	TYPE	PRODUCT SPECIFICATION		NUMBER	BUS-12-067
	TITLE	Crimp-to Wire, Mini-PV™ Receptacles and Mini-Latch Housings		PAGE	11 of 16
				REVISION	K
				AUTHORIZED BY	H.T. Brewbaker
				DATE	31-May-06
				CLASSIFICATION	UNRESTRICTED

7.8 Probe Damage - After testing in accordance with MIL-STD-1344, Method 2006, the individual contact withdrawal force shall not be less than the value specified in Table III (see paragraph 7.5). The following details shall apply:

- a. Moment - 0.125 inch pounds (A= 0.025)
- b. Probe Depth - To reach apex of spring
- c. Stress Point - Contact spring member only

8.0 Environmental Conditions

After exposure to the following environmental conditions in accordance with the specified test procedure and/or details, the product shall show no physical damage and shall meet the electrical and mechanical requirements per paragraphs 6.0 and 7.0 as specified in the Table VI test sequences.

8.1 Thermal Shock - MIL-STD-202, Method 107, Unmated.

- a. Temperature Range - Between -55 and + 105 deg C
- b. Time at Each Temperature - Per sample mass
- c. Transfer Time - 5 minutes, maximum
- d. Number of Cycles - 5

8.2 Humidity - MIL-STD-1344, Method 1002, Type I, Unmated. Measurements taken within one hour of removal from humidity chamber.

- a. Test Temperature - + 40 +/- 2 deg C.
- b. Test Duration - 96 hour
- c. Test Relative Humidity - 90-95%
- d. Test Condition - B

8.3 High Temperature Life - MIL-STD-1344, Method 1005, Mated.

- a. Test Temperature - 3 (+85 +/- 3 deg C)
- b. Test Duration - B (250 hours)
- c. Operating Conditions - rated current (see paragraph 6.1, Figure 1A) through all contacts
- d. Duty Cycle - 45 minutes ON, 15 minutes OFF

8.4 Shock - MIL-STD-1344, Method 2004, Test Condition A, Mated. During and after each shock, the contacts shall evidence no discontinuity greater than one microsecond.

8.5 Vibration - MIL-STD-1344, Method 2005, Test Condition III, Mated. During vibration along each axis, the contacts shall evidence no discontinuity greater than one microsecond.

	TYPE	PRODUCT SPECIFICATION		NUMBER	BUS-12-067
	TITLE			PAGE	REVISION
Crimp-to Wire, Mini-PV™ Receptacles and Mini-Latch Housings			12 of 16	K	
			AUTHORIZED BY	DATE	
			H.T. Brewbaker	31-May-06	
			CLASSIFICATION		
			UNRESTRICTED		

8.6 Flowers of Sulphur - Unmated.

- a. Test Medium - Flowers of Sulphur
- b. Test Relative Humidity - 80%
- c. Test Temperature - + 65 +/- 5 deg C.
- e. Test Duration - 240 hours.
- f. Disturbance Prior to Electrical Test - 5 matings with male header.

8.7 Salt Spray - For 15 u" or greater gold plated terminals only. MIL-STD-1344, Method 1001, Test Condition B, Mated and Unmated.

- a. Test Atmosphere - 5% Salt Fog

9.0 QUALITY ASSURANCE PROVISIONS

9.1 Equipment Calibration

All test equipment and inspection facilities used in the performance of any test shall be maintained in a calibration system in accordance with ISO 9001/9002 and ANSI/ASQC M-1.

9.2 Inspection Conditions

Unless otherwise specified herein, all inspections shall be performed under the following ambient conditions:

- a. Temperature - + 25 +/- 5 deg C.
- b. Relative Humidity - 30% to 60%.
- c. Barometric Pressure - Local ambient

9.3 Sample Quantity and Description

9.3.1 Connector - Ten (10) of the largest and seven (7) of the smallest population connectors shall be subjected to the qualification inspection. A separate group of seventeen (17) connectors shall be subjected to test for each combination of retention spring thickness, contact area plating, and housing contact spacing.

	TYPE	PRODUCT SPECIFICATION		NUMBER	BUS-12-067	
	TITLE			PAGE	REVISION	
Crimp-to Wire, Mini-PV™ Receptacles and Mini-Latch Housings			13 of 16	K		
			AUTHORIZED BY	DATE		
			H.T. Brewbaker	31-May-06		
			CLASSIFICATION			
			UNRESTRICTED			

9.3.2 Contact - Sixty (60) contacts crimped to each size wire as specified in Table V shall be subjected to the qualification inspection. A separate group of sixty (60) contacts shall be subjected to test for each combination of contact area, plating and wire size.

TABLE V - CONTACT SAMPLES

Wire Size, AWG	CRIMP HEIGHT	
	MINIMUM	MAXIMUM
18	X	
20		X
22	X	
26		X
28	X	
32		X
34	X	
36		X

9.4 Preparation of Samples

9.4.1 Mating Headers - Seventeen (17) mating headers, ten of the largest and seven of the smallest population, configured and conforming to the requirements of Figure 6 shall be prepared.

9.4.2 Receptacles

Sample Number	Description	Quantity Connector Assemblies	Number of Terminals Tested
1	Individuals contacts crimped to each size wire as specified in table V.	0	30ea.
2	Individual contacts crimped each size wire as specified in table V.	0	30ea.
3	3 largest & 3 smallest populated connectors terminals crimped to wire	6	30*ea.
4	3 largest populated connector with terminals crimped without wires.	3	30
5	1 largest & 1 smallest populated connectors with terminals crimped to dual wires	2	All
6	2 largest & 2 smallest populated connectors with terminals crimped to dual wires	4	All
7	1 largest & 1 smallest populated connectors with terminals crimped to dual wires.	2	All

*NOTE: Except all contacts used for total mating force.

*NOTE: Except use a total of 30 contacts for individuals contact insertion/withdrawal forces.

9.4.3 Stranded Wire - All stranded wire used in these qualification test samples shall conform to the requirements of MIL-W-16878, Type B.

	TYPE	PRODUCT SPECIFICATION		NUMBER	BUS-12-067		
	TITLE	Crimp-to Wire, Mini-PV™ Receptacles and Mini-Latch Housings		PAGE	14 of 16	REVISION	K
				AUTHORIZED BY	H.T. Brewbaker	DATE	31-May-06
				CLASSIFICATION	UNRESTRICTED		

9.5 Acceptance

9.5.1 Electrical and mechanical requirements placed on test samples as indicated in paragraphs 6.0 and 7.0 shall be established from test data using appropriate statistical techniques or shall otherwise be customer specified, and all samples tested in accordance with this product specification shall meet the stated requirements.

9.5.2 Failures attributed to equipment, test setup, or operator error shall not disqualify the product. If product failure occurs, corrective action shall be taken and samples resubmitted for qualification.

9.6 Qualification Testing

Qualification testing shall be performed on sample units produced with equipment and procedures normally used in production. The test sequence shall be as shown in Table VI.

9.7 Requalification Testing

If any of the following conditions occur, the responsible product engineer shall initiate requalification testing consisting of all applicable parts of the qualification test matrix, Table VI.

- a. A significant design change is made to the existing product which impacts the product form, fit or function. Examples of significant changes shall include, but not be limited to, changes in the plating material composition or thickness, contact force, contact surface geometry, contact base material, or contact lubrication requirements.
- b. A significant change is made to the manufacturing process which impacts the product form, fit or function.
- c. A significant event occurs during production or end use requiring corrective action to be taken relative to the product design or manufacturing process.



TYPE

PRODUCT SPECIFICATION

NUMBER

BUS-12-067

TITLE

Crimp-to Wire, Mini-PV™ Receptacles and Mini-Latch Housings

PAGE

15 of 16

REVISION

K

AUTHORIZED BY

H.T. Brewbaker

DATE

31-May-06

CLASSIFICATION

UNRESTRICTED

Table VI - Qualification Test Matrix								
		Sample Number						
		1	2	3	4	5	6	7
Sample Assemblies		0	0	6	3	2	4	2
Terminals Tested		30	30	30*	30	All	All	All**
Test Condition	Para.							
Visual Examination		1,4	1,9	1,4	1,7	1,9	1,9	1,7,17
Total Mating Force	7.3			2*				
Individual Contact Insertion Force	7.4				2			2
Individual Contact Withdrawal Force	7.5				3			3,16
Contact Retention	7.1			3				
Crimp Height Measurement	TA-75	2						
Crimp Tensile Strength	7.7	3						
Low Level Contact Resistance	6.2					2,4,6,8	2,4,6,8	4,8,10,12,14
Low Level Crimp Resistance	6.3		2,4,6,8					
Insulation Resistance	6.4				4			
Dielectric Withstanding Voltage	6.5				5			
Capacitance	6.6				6			
Thermal Shock	8.1		3			3		
Humidity	8.2		5			5		
High Temperature Life	8.3		7			7		
Shock	8.4							5
Vibration	8.5							6
Durability	7.6						3	9
Flowers of Sulfur	8.6						5	11
Salt Spray	8.7						7	13
Probe Damage	7.8							15

	TYPE	PRODUCT SPECIFICATION		NUMBER	BUS-12-067	
	TITLE			PAGE	REVISION	
Crimp-to Wire, Mini-PV™ Receptacles and Mini-Latch Housings			16 of 16	K		
			AUTHORIZED BY	DATE		
			H.T. Brewbaker	31-May-06		
			CLASSIFICATION			
			UNRESTRICTED			

REVISION RECORD

<u>REV</u>	<u>PAGE</u>	<u>DESCRIPTION</u>	<u>EC#</u>	<u>DATE</u>
A	9	Change withdrawal forces from 100 to 75	V13467	05/13/86
B	All	3.5.5 Realign sentence 3.6.6 Added, .000015 Au & 1000 Cycles 3.7.2 Test Condition "A" change to "B" 3.5.3 Added L.L. Crimp Resistance to Table IX 3.5.6 Added Capacitance to Table IX 3.5.3 Added L.L. Crimp Resistance to Table XI 3.5.6 Added Capacitance to Table XI	V13871	02/19/87
C	All		V11789	05/25/91
D	1,3, 6,8	1.1 Add "Pin" 3.3.2 Add "Over 50 m"..." 3.6.2 Add 5.8 3.6.3 Add 5.8 3.6.5 Add 5.8	V31896	11/02/93
E	All	Rewrite	V51420	03/07/96
F	8	Add DIM. "D" to Figure 5 and change guardian	V81285	07/22/98
G	All	Revised format to be consistent with GS-01-001, and change BERG, Dupont, etc. references to FCI.	V01904	07/31/00
H	3	5.2.3 Changed V-1 or better to V-0 5.2.4 Changed V-1 or better to V-0	V20332	02/13/02
J	1, 3	Add sections 3.1 and 3.2, add LF information to section 5.3.1 and 5.3.2.	V05-1112	12/13/05
K	All	Change logo	V06-0526	05/31/06