

NUMBER GS-12-603	TYPE PRODUCT SPECIFICATION		
TITLE 1mm CONTACT SPACING FPC/FFC CONNECTOR (HFW__R-1STE1MTLF / HFW__R-2STE1MTLF)		PAGE 1 of 8	REVISION C
		AUTHORIZED BY DENNIS GOH	DATE 03 Feb 10
		CLASSIFICATION UNRESTRICTED	

1.0 OBJECTIVE

This specification defines the performance, test quality and reliability requirement of the FPC/FFC connector (HFW__R-1STE1MTLF / HFW__R-2STE1MTLF).

2.0 SCOPE

This specification is applied to the requirements for the connector which the edge of 1mm spacing FPC(Flexible Printed Circuit) and FFC(Flexible Flat Cable) are inserted into directly and connected to and which copes with automatic mounting and SMT.

3.0 GENERAL

This specification is comprised of the following sections:

<u>Paragraph</u>	<u>Title</u>
1.0	OBJECTIVE
2.0	SCOPE
3.0	GENERAL
4.0	DEFINITIONS
5.0	TEST PROCEDURE
6.0	REFERENCE DOCUMENTS
7.0	NOTES
8.0	RECORD RETENTION

Catalog No. Structure

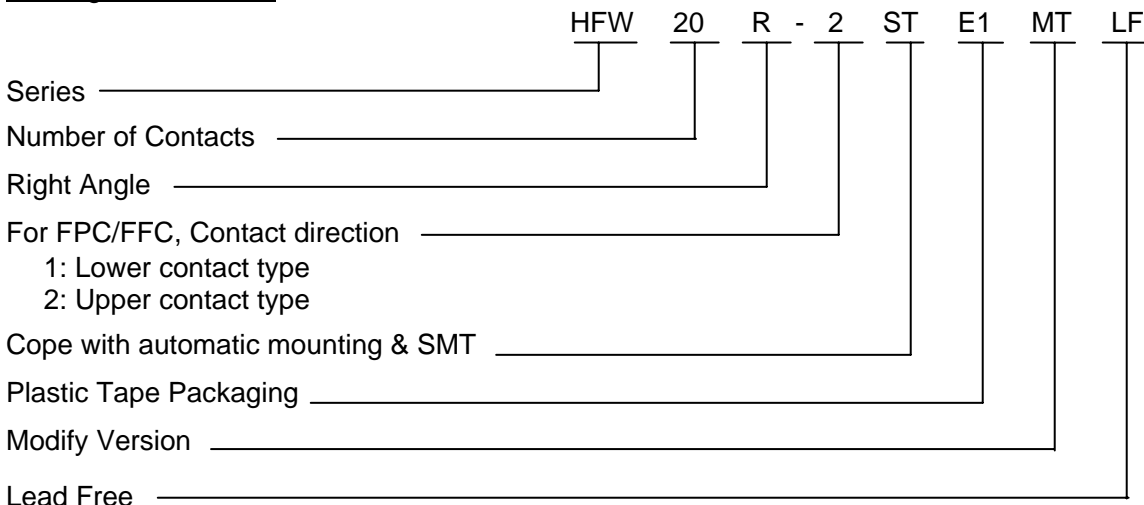

NUMBER GS-12-603	TYPE PRODUCT SPECIFICATION		
TITLE 1mm CONTACT SPACING FPC/FFC CONNECTOR (HFW__R-1STE1MTLF / HFW__R-2STE1MTLF)		PAGE 2 of 8	REVISION C
		AUTHORIZED BY DENNIS GOH	DATE 03 Feb 10
		CLASSIFICATION UNRESTRICTED	

4.0 DEFINITIONS

Rating

5.1 Voltage : A.C. 50V

D.C. 50V

5.2 Current : A.C. 0.5A

D.C. 0.5A (Refer to the following note.)

5.3 Operating Temperature : -55°C ~ +105°C

(Including terminal temperature rises, FPC must be met temperature range specified in this standard)

Note

Allowable maximum current for one contact is 1A. Total allowable current for a whole connector is the value which is shown in the following figure.

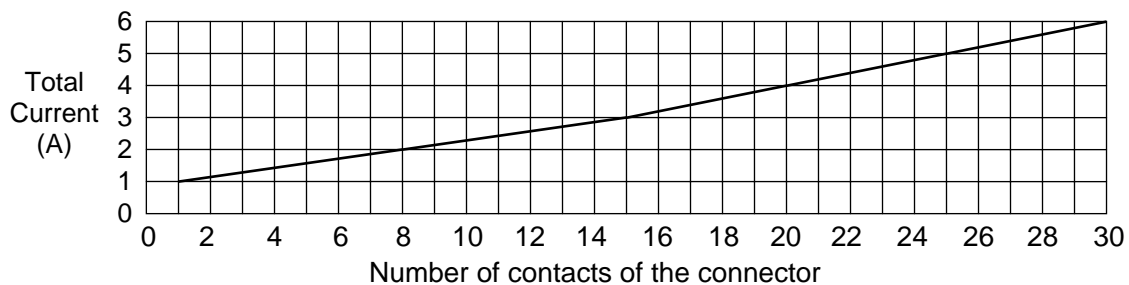

5.0 TEST PROCEDURE

5.1 Electrical Performance

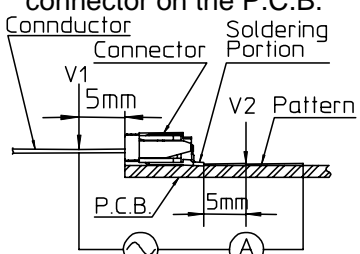
No.	Test Item	Test Method	Requirements
5.1.1	Contact resistance	<p>1) Measure contact resistance between V_1-V_2 by voltage drop method using the following circuit by mating accommodated conductor after reflow soldering the connector on the P.C.B.</p>  <p>2) Open circuit voltage : Less than A.C. 20mV</p> <p>3) Test current : Less than A.C. 20mA</p>	<p>1) Initial value : Less than 30mΩ</p> <p>2) Contact resistance after the test is in accordance with the value specified in each test item.</p>

NUMBER GS-12-603	TYPE PRODUCT SPECIFICATION		
TITLE 1mm CONTACT SPACING FPC/FFC CONNECTOR (HFW__R-1STE1MTLF / HFW__R-2STE1MTLF)		PAGE 3 of 8	REVISION C
		AUTHORIZED BY DENNIS GOH	DATE 03 Feb 10
		CLASSIFICATION UNRESTRICTED	

5.1.2	Insulation resistance	<ol style="list-style-type: none"> 1) Measure insulation resistance between adjacent contacts in a connector individual. 2) Test voltage : D.C. 500V 3) Read value one minute after applying test voltage. 	1) More than 500MΩ
5.1.3	Dielectric withstanding voltage	<ol style="list-style-type: none"> 1) For one minute, apply A.C. 500V between adjacent contacts in a connector individual. 2) Set current : A.C. 1mA 	1) Free from any short circuit and insulation breakdown.

5.2 Mechanical Performance

No.	Test Item	Test Method	Requirements
5.2.1	Durability (Insertion and extraction)	<ol style="list-style-type: none"> 1) Measure contact resistance before and after the test by the method in clause 5.1.1 by using the accommodated conductor 2) Number of insertion and extraction : 30 times. 3) Speed of insertion and extraction : Less than 10 times per minute. 	<ol style="list-style-type: none"> 1) Initial contact resistance : Less than 30mΩ 2) Contact resistance after the test : Less than 50mΩ 2) Free from any defect such as break etc. on the connector and the conductor.
5.2.2	Vibration (Sinusoidal)	<p>JIS C 0040</p> <ol style="list-style-type: none"> 1) Frequency range : 10 ~ 500Hz 2) Amplitude : 0.75mm or Acceleration : 100m/s² 3) Sweep rate : 1 octave/minute 4) Kind of test : Sweep endurance test 5) Test time : 10 cycles 	<ol style="list-style-type: none"> 1) During the test, no circuit opening for more than 1μs 2) Free from any defect such as break, deformation, loosing and falling off etc. on each portion of the connector.

NUMBER GS-12-603	TYPE PRODUCT SPECIFICATION		
TITLE 1mm CONTACT SPACING FPC/FFC CONNECTOR (HFW__R-1STE1MTLF / HFW__R-2STE1MTLF)		PAGE 4 of 8	REVISION C
		AUTHORIZED BY DENNIS GOH	DATE 03 Feb 10
		CLASSIFICATION UNRESTRICTED	

5.3 Environmental Performance

No.	Test Item	Test Method	Requirements
5.3.1	Damp heat (Steady state)	<p>JIS C 0022</p> <ol style="list-style-type: none"> 1) Measure contact resistance before and after the test by the method in clause 5.1.1 by using the accommodated conductor. 2) Measure insulation resistance after the test by the method in clause 5.1.2. 3) Bath temperature : 40°C 4) Bath humidity : 90~95% (relative humidity) 5) Period of exposure : 48 hours 6) Expose conductor and connector after mating them (Without insertion and extraction) and dry them naturally after post treatment. 	<ol style="list-style-type: none"> 1) Initial contact resistance : Less than 30mΩ 2) Contact resistance after the test : Less than 50mΩ 3) Insulation resistance after the test : More than 100MΩ
5.3.2	Salt spray	<p>JIS C 0023</p> <ol style="list-style-type: none"> 1) Measure contact resistance before and after the test according to the method in clause 5.1.1 by using accommodated conductor. 2) Salt solution concentration : 5% 3) Period of exposure : 48 hours 4) Expose conductor and connector in mated condition and dry them naturally after post treatment. (24 hours) 	<ol style="list-style-type: none"> 1) Initial contact resistance : Less than 30mΩ 2) Contact resistance after the test : Less than 50mΩ

NUMBER GS-12-603	TYPE PRODUCT SPECIFICATION		
TITLE 1mm CONTACT SPACING FPC/FFC CONNECTOR (HFW_ _R-1STE1MTLF / HFW_ _R-2STE1MTLF)		PAGE 5 of 8	REVISION C
		AUTHORIZED BY DENNIS GOH	DATE 03 Feb 10
CLASSIFICATION UNRESTRICTED			

No.	Test Item	Test Method	Requirements															
5.3.3	Change of temperature	<p>JIS C 0025</p> <p>1) Measure contact resistance before and after the test according to the method in clause 5.1.1 by mating accommodated conductor.</p> <p>2) One cycle of temperature is as follow and test 5 cycles.</p> <table border="1" data-bbox="553 779 959 947"> <thead> <tr> <th>Step</th> <th>Temp.(°C)</th> <th>Time (min.)</th> </tr> </thead> <tbody> <tr> <td>1</td> <td>-55±3</td> <td>30</td> </tr> <tr> <td>2</td> <td>25±2</td> <td>2 ~ 3</td> </tr> <tr> <td>3</td> <td>85±2</td> <td>30</td> </tr> <tr> <td>4</td> <td>25±2</td> <td>2 ~ 3</td> </tr> </tbody> </table> <p>3) Expose conductor and connector by mating them and leave them under normal temperature.</p>	Step	Temp.(°C)	Time (min.)	1	-55±3	30	2	25±2	2 ~ 3	3	85±2	30	4	25±2	2 ~ 3	<p>1) Initial contact resistance : Less than 30mΩ</p> <p>2) Contact resistance after the test : Less than 50mΩ</p> <p>3) Free from any defect such as crack, warping and deformation etc. on each portion of the connector.</p>
Step	Temp.(°C)	Time (min.)																
1	-55±3	30																
2	25±2	2 ~ 3																
3	85±2	30																
4	25±2	2 ~ 3																

5.4 Other performance

No.	Test Item	Test Method	Requirements
5.4.1	Soldering (Resistance to reflow soldering)	<p>1) Solder by setting reflow bath on the following condition.</p> <p>2) Preheating : 150±10°C, 60~120 s</p> <p>3) Soldering : 240±5°C, 30±1s</p> <p>NOTE: Temperature must be measured at contact terminal portion and peak temperature on the upper surface of P.C.B must be less than 260°C.</p> <p>(see Diagram A)</p> <p>4) Solder paste to be used is JIS Z 3282 H60A or H63A. Soldering particle is more than 200 mesh and flux is inactive rosin family flux.</p>	<p>1) Contact resistance after the test : Less than 50mΩ</p> <p>2) Insulation resistance after the test : More than 100MΩ</p> <p>3) No short circuit and insulation breakdown for dielectric withstanding voltage test after this test.</p> <p>4) Free from any damage on performance and contact performance after soldering.</p>



NUMBER GS-12-603	TYPE PRODUCT SPECIFICATION		
TITLE 1mm CONTACT SPACING FPC/FFC CONNECTOR (HFW__R-1STE1MTLF / HFW__R-2STE1MTLF)		PAGE 6 of 8	REVISION C
		AUTHORIZED BY DENNIS GOH	DATE 03 Feb 10
		CLASSIFICATION UNRESTRICTED	

Diagram A

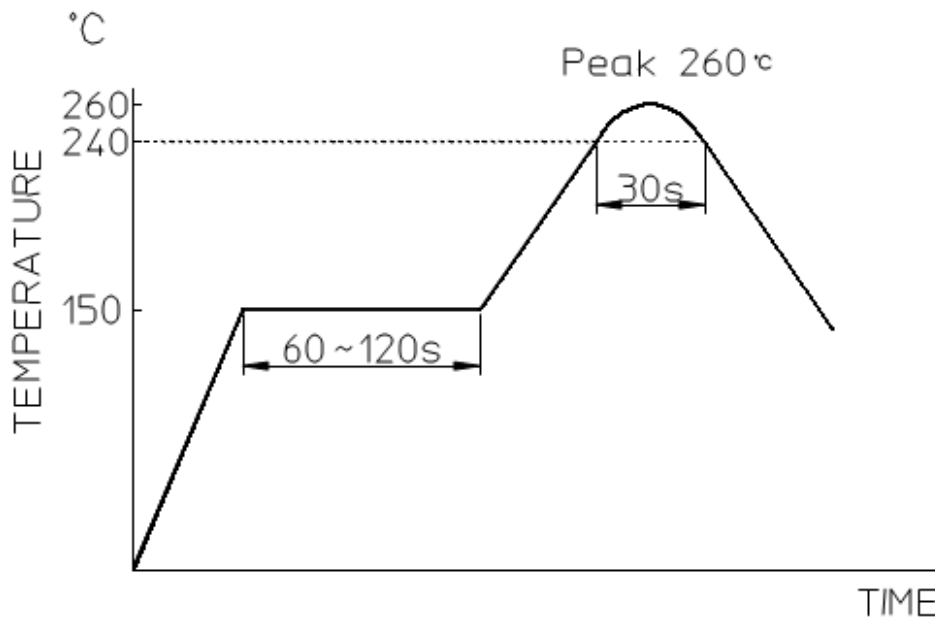

Resistance reflow soldering profile

5.4.2	Soldering (Solderability) (Reflow)	<ol style="list-style-type: none"> 1) Solder by setting reflow bath on the following condition. 2) Preheating : 150±10°C, 60~120 s 3) Soldering : 230±5°C, 10±1 s <p>Note : Temperature must be measured at contact terminal portion and peak temperature on the upper surface of P.C.B. must be less than 260°C.</p> <ol style="list-style-type: none"> 4) Solder paste to be used is JIS Z 3282 H60A or H63A. Soldering particle is more than 200 mesh and flux is inactive rosin family flux. 	<ol style="list-style-type: none"> 1) Actual soldered area must be more than 90% of the dipped area intended to be soldered.
-------	--	--	---

NUMBER GS-12-603	TYPE PRODUCT SPECIFICATION		
TITLE 1mm CONTACT SPACING FPC/FFC CONNECTOR (HFW_ _R-1STE1MTLF / HFW_ _R-2STE1MTLF)		PAGE 7 of 8	REVISION C
		AUTHORIZED BY DENNIS GOH	DATE 03 Feb 10
		CLASSIFICATION UNRESTRICTED	

5.4.3	Terminal / Housing Retention Force	1) Apply axial pull out force at the speed rate of 25±3mm/minute on the terminal assembled in the housing.	1) 5.9N (0.6kgf) minimum
5.4.4	Cable insertion force and Extraction force (Reference)	1) Measure insertion force and retention force by using the accommodated conductor (cable)	Initial Insertion: Less than 1.7N/contact Retention: More than 0.49N/contact

6.0 REFERENCE DOCUMENTS

Standards and Specifications

- JIS C 5402 Method for Test of Connectors for Electronic Equipment
JIS C 0806 Packaging of Electronic Components on Continuous Tapes
 (Surface Mount Components)
UL - 94 TESTS FOR FLAMMABILITY OF PLASTIC MATERIALS FOR PARTS
 IN DEVICES AND APPLIANCES

7.0 NOTES

7.1 Indication and Packaging

7.1.1 Indication

- 1) Catalog number and lot number are not indicated on the connector.
- 2) Catalog number and quantity shall be indicated on the surface of the package box.

7.1.2 Packaging

- 1) The connector individuals are packed by tapes with specified quantity in accordance with [JIS C 0806 "Packaging of Electronic Components on Continuous Tapes (Surface Mount components)"] and put into package box in accordance with our packaging specification.

7.2 Remarks

- 7.2.1 Insertion and extraction force for accommodated conductor (cable) specified in clause 5.4.4 differs due to it's kind, structure and surface treatment of conductor. Therefore, the force value specified in the clause for performance is reference value.

NUMBER GS-12-603	TYPE PRODUCT SPECIFICATION		
TITLE 1mm CONTACT SPACING FPC/FFC CONNECTOR (HFW__R-1STE1MTLF / HFW__R-2STE1MTLF)		PAGE 8 of 8	REVISION C
		AUTHORIZED BY DENNIS GOH	DATE 03 Feb 10
		CLASSIFICATION UNRESTRICTED	

8.0 RECORD RETENTION

REV.	PAGE	DESCRIPTION	ECR #	DATE
A	All	New Release	S09-0027	03 FEB 09
B	2 5, 6	Update Operating Temperature from -20°C ~ +85°C to -20°C ~ +105°C. Add "Diagram A" Resistance Reflow Soldering Profile.	S09-0029	05 FEB 09
C	2	Change operating temperature from -20°C ~ +105°C to -55°C ~ +105°C	S10-0025	03FEB10