



Is Now Part of



ON Semiconductor®

To learn more about ON Semiconductor, please visit our website at

www.onsemi.com

ON Semiconductor and the ON Semiconductor logo are trademarks of Semiconductor Components Industries, LLC dba ON Semiconductor or its subsidiaries in the United States and/or other countries. ON Semiconductor owns the rights to a number of patents, trademarks, copyrights, trade secrets, and other intellectual property. A listing of ON Semiconductor's product/patent coverage may be accessed at www.onsemi.com/site/pdf/Patent-Marking.pdf. ON Semiconductor reserves the right to make changes without further notice to any products herein. ON Semiconductor makes no warranty, representation or guarantee regarding the suitability of its products for any particular purpose, nor does ON Semiconductor assume any liability arising out of the application or use of any product or circuit, and specifically disclaims any and all liability, including without limitation special, consequential or incidental damages. Buyer is responsible for its products and applications using ON Semiconductor products, including compliance with all laws, regulations and safety requirements or standards, regardless of any support or applications information provided by ON Semiconductor. "Typical" parameters which may be provided in ON Semiconductor data sheets and/or specifications can and do vary in different applications and actual performance may vary over time. All operating parameters, including "Typicals" must be validated for each customer application by customer's technical experts. ON Semiconductor does not convey any license under its patent rights nor the rights of others. ON Semiconductor products are not designed, intended, or authorized for use as a critical component in life support systems or any FDA Class 3 medical devices or medical devices with a same or similar classification in a foreign jurisdiction or any devices intended for implantation in the human body. Should Buyer purchase or use ON Semiconductor products for any such unintended or unauthorized application, Buyer shall indemnify and hold ON Semiconductor and its officers, employees, subsidiaries, affiliates, and distributors harmless against all claims, costs, damages, and expenses, and reasonable attorney fees arising out of, directly or indirectly, any claim of personal injury or death associated with such unintended or unauthorized use, even if such claim alleges that ON Semiconductor was negligent regarding the design or manufacture of the part. ON Semiconductor is an Equal Opportunity/Affirmative Action Employer. This literature is subject to all applicable copyright laws and is not for resale in any manner.



October 2015

MMSZ5226B - MMSZ5257B Zeners

Tolerance = 5%

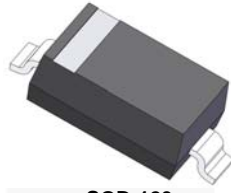

SOD-123

* Band marking denotes cathode.

Absolute Maximum Ratings

Stresses exceeding the absolute maximum ratings may damage the device. The device may not function or be operable above the recommended operating conditions and stressing the parts to these levels is not recommended. In addition, extended exposure to stresses above the recommended operating conditions may affect device reliability. The absolute maximum ratings are stress ratings only. Values are at $T_A = 25^\circ\text{C}$ unless otherwise noted.

Symbol	Parameter	Value	Units
P_D	Power Dissipation at $T_A = 25^\circ\text{C}$	500	mW
$R_{\theta JA}$	Thermal Resistance, Junction to Ambient ⁽¹⁾	340	$^\circ\text{C}/\text{W}$
T_{STG}	Storage Temperature Range	-55 to +150	$^\circ\text{C}$
T_J	Operating Junction Temperature	+150	$^\circ\text{C}$

Note:

1. FR-4 or FR-5 = 3.5 inch \times 1.5 inch using minimum recommended land pads.

Electrical Characteristics

Values are at $T_A = 25^\circ\text{C}$ unless otherwise noted.

Device	Mark	V_Z (V) @ I_Z (mA)				Z_Z (Ω) @ I_Z (mA)		Z_{ZK} (Ω) @ I_{ZK} (mA)		I_R (μA) @ V_R (V)	
		Min.	Typ.	Max.	I_Z (mA)						
MMSZ5226B	D1	3.135	3.3	3.465	20	28	20	1,600	0.25	25	1.0
MMSZ5227B	D2	3.42	3.6	3.78	20	24	20	1,700	0.25	15	1.0
MMSZ5228B	D3	3.705	3.9	4.095	20	23	20	1,900	0.25	10	1.0
MMSZ5229B	D4	4.085	4.3	4.515	20	22	20	2,000	0.25	5.0	1.0
MMSZ5230B	D5	4.465	4.7	4.935	20	19	20	1,900	0.25	5.0	2.0
MMSZ5231B	E1	4.845	5.1	5.355	20	17	20	1,600	0.25	5.0	2.0
MMSZ5232B	E2	5.32	5.6	5.88	20	11	20	1,600	0.25	5.0	3.0
MMSZ5233B	E3	5.7	6	6.3	20	7.0	20	1,600	0.25	5.0	3.5
MMSZ5234B	E4	5.89	6.2	6.51	20	7.0	20	1,000	0.25	5.0	4.0
MMSZ5235B	E5	6.46	6.8	7.14	20	5.0	20	750	0.25	3.0	5.0
MMSZ5236B	F1	7.125	7.5	7.875	20	6.0	20	500	0.25	3.0	6.0
MMSZ5237B	F2	7.79	8.2	8.61	20	8.0	20	500	0.25	3.0	6.5
MMSZ5238B	F3	8.265	8.7	9.135	20	8.0	20	600	0.25	3.0	6.5
MMSZ5239B	F4	8.645	9.1	9.555	20	10	20	600	0.25	3.0	7.0
MMSZ5240B	F5	9.5	10	10.5	20	17	20	600	0.25	3.0	8.0
MMSZ5241B	H1	10.45	11	11.55	20	22	20	600	0.25	2.0	8.4
MMSZ5242B	H2	11.4	12	12.6	20	30	20	600	0.25	1.0	9.1
MMSZ5243B	H3	12.35	13	13.65	9.5	13	9.5	600	0.25	0.5	9.9
MMSZ5244B	H4	13.3	14	14.7	9.0	15	9.0	600	0.25	0.1	10
MMSZ5245B	H5	14.25	15	15.75	8.5	16	8.5	600	0.25	0.1	11
MMSZ5246B	J1	15.2	16	16.8	7.8	17	7.8	600	0.25	0.1	12
MMSZ5247B	J2	16.15	17	17.85	7.4	19	7.4	600	0.25	0.1	13
MMSZ5248B	J3	17.1	18	18.9	7.0	21	7.0	600	0.25	0.1	14
MMSZ5249B	J4	18.05	19	19.95	6.6	23	6.6	600	0.25	0.1	14
MMSZ5250B	J5	19	20	21	6.2	25	6.2	600	0.25	0.1	15
MMSZ5251B	K1	20.92	22	23.1	5.6	29	5.6	600	0.25	0.1	17
MMSZ5252B	K2	22.8	24	25.2	5.2	33	5.2	600	0.25	0.1	18
MMSZ5253B	K3	23.75	25	26.25	5.0	35	5.0	600	0.25	0.1	19
MMSZ5254B	K4	25.65	27	28.35	4.6	41	4.6	600	0.25	0.1	21
MMSZ5255B	K5	26.6	28	29.4	4.5	44	4.5	600	0.25	0.1	21
MMSZ5256B	M1	28.5	30	31.5	4.2	49	4.2	600	0.25	0.1	23
MMSZ5257B	M2	31.35	33	34.65	3.8	58	3.8	700	0.25	0.1	25

V_F Forward Voltage = 0.9 V Maximum at $I_F = 10$ mA for all MMSZ5200 series

Typical Performance Characteristics



Figure 1. Zener Current vs. Zener Voltage



Figure 2. Zener Current vs. Zener Impedance



Figure 3. 3.3 Zener Voltage vs. Temperature



Figure 4. 5.1 Zener Voltage vs. Temperature



Figure 5. 12 Zener Voltage vs. Zener Temperature



Figure 6. 33 Zener Voltage vs. Zener Temperature

Physical Dimensions

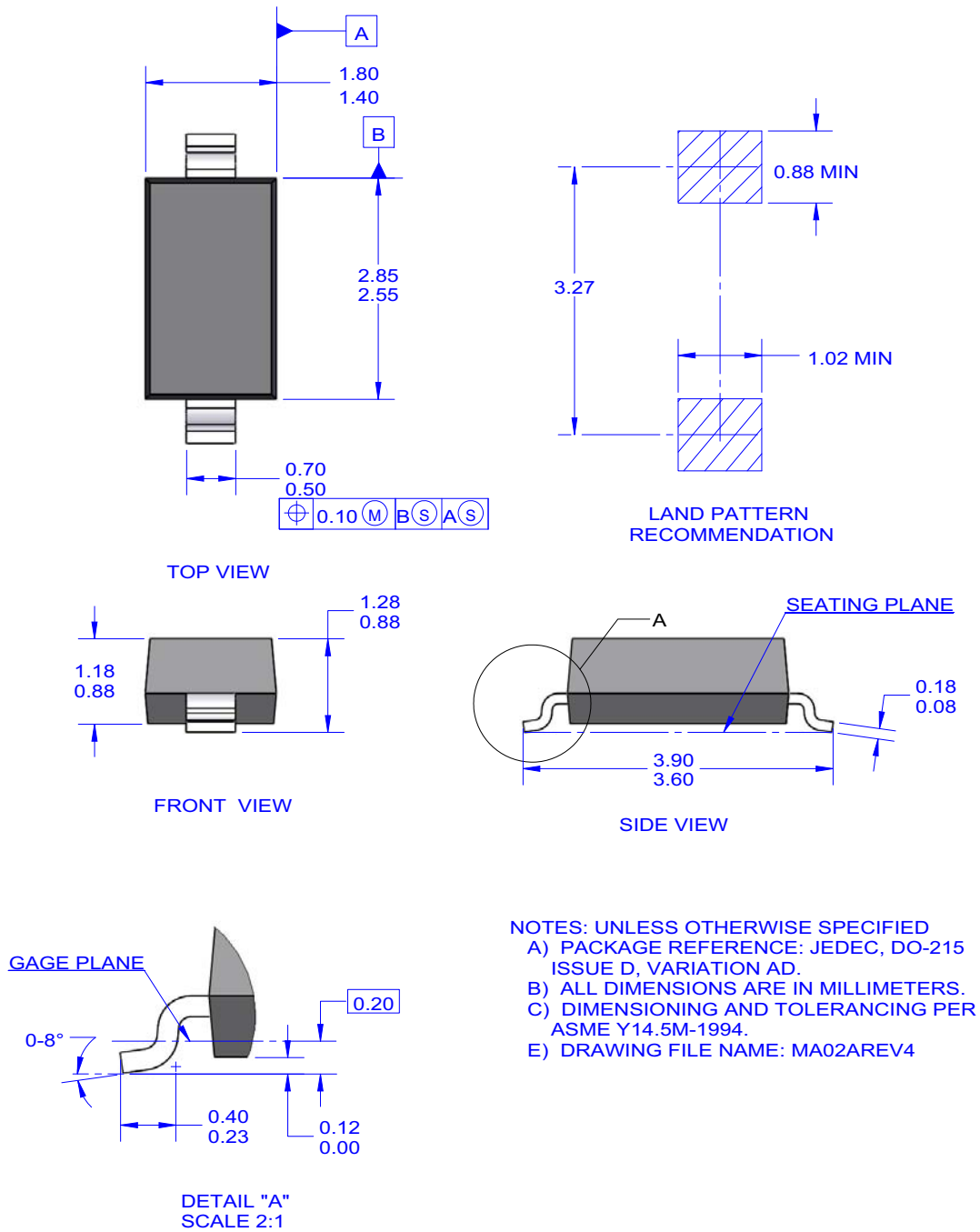







Figure 7. 2-LEAD, SOD123, JEDEC DO-219



TRADEMARKS

The following includes registered and unregistered trademarks and service marks, owned by Fairchild Semiconductor and/or its global subsidiaries, and is not intended to be an exhaustive list of all such trademarks.

- | | | | |
|----------------------------------------------------------------------------------------------|------------------------------------------------|-------------------------------------------------------------------------------------|-----------------------------------------------------------------------------------------------------|
| AccuPower™ | F-PFS™ | OPTOPLANAR® |  SYSTEM GENERAL® |
| AttitudeEngine™ | FRFET® |  ® | TinyBoost® |
| Awinda® | Global Power Resource™ | Power Supply WebDesigner™ | TinyBuck® |
| AX-CAP®* | GreenBridge™ | PowerTrench® | TinyCalc™ |
| BitSiC™ | Green FPS™ | PowerXS™ | TinyLogic® |
| Build it Now™ | Green FPS™ e-Series™ | Programmable Active Droop™ | TINYOPTO™ |
| CorePLUS™ | Gmax™ | QFET® | TinyPower™ |
| CorePOWER™ | GTO™ | QS™ | TinyPWM™ |
| CROSSVOLT™ | IntelliMAX™ | Quiet Series™ | TinyWire™ |
| CTL™ | ISOPLANAR™ | RapidConfigure™ | TranSiC™ |
| Current Transfer Logic™ | Making Small Speakers Sound Louder and Better™ |  ™ | TriFault Detect™ |
| DEUXPEED® | MegaBuck™ | Saving our world, 1mW/W/kW at a time™ | TRUECURRENT®* |
| Dual Cool™ | MICROCOUPLER™ | SignalWise™ | μSerDes™ |
| EcoSPARK® | MicroFET™ | SmartMax™ |  SerDes™ |
| EfficientMax™ | MicroPak™ | SMART START™ | UHC® |
| ESBC™ | MicroPak2™ | Solutions for Your Success™ | Ultra FRFET™ |
|  Fairchild® | MillerDrive™ | SPM® | UniFET™ |
| Fairchild Semiconductor® | MotionMax™ | STEALTH™ | VCX™ |
| FACT Quiet Series™ | MotionGrid® | SuperFET® | VisualMax™ |
| FACT® | MTi® | SuperSOT™-3 | VoltagePlus™ |
| FastvCore™ | MTx® | SuperSOT™-6 | XS™ |
| FETBench™ | MVN® | SuperSOT™-8 | Xsens™ |
| FPS™ | mWSaver® | SupreMOS® | 仙童® |
| | OptoHiT™ | SyncFET™ | |
| | OPTOLOGIC® | Sync-Lock™ | |

* Trademarks of System General Corporation, used under license by Fairchild Semiconductor.

DISCLAIMER

FAIRCHILD SEMICONDUCTOR RESERVES THE RIGHT TO MAKE CHANGES WITHOUT FURTHER NOTICE TO ANY PRODUCTS HEREIN TO IMPROVE RELIABILITY, FUNCTION, OR DESIGN. TO OBTAIN THE LATEST, MOST UP-TO-DATE DATASHEET AND PRODUCT INFORMATION, VISIT OUR WEBSITE AT [HTTP://WWW.FAIRCHILDSEMI.COM](http://www.fairchildsemi.com). FAIRCHILD DOES NOT ASSUME ANY LIABILITY ARISING OUT OF THE APPLICATION OR USE OF ANY PRODUCT OR CIRCUIT DESCRIBED HEREIN; NEITHER DOES IT CONVEY ANY LICENSE UNDER ITS PATENT RIGHTS, NOR THE RIGHTS OF OTHERS. THESE SPECIFICATIONS DO NOT EXPAND THE TERMS OF FAIRCHILD'S WORLDWIDE TERMS AND CONDITIONS, SPECIFICALLY THE WARRANTY THEREIN, WHICH COVERS THESE PRODUCTS.

AUTHORIZED USE

Unless otherwise specified in this data sheet, this product is a standard commercial product and is not intended for use in applications that require extraordinary levels of quality and reliability. This product may not be used in the following applications, unless specifically approved in writing by a Fairchild officer: (1) automotive or other transportation, (2) military/aerospace, (3) any safety critical application – including life critical medical equipment – where the failure of the Fairchild product reasonably would be expected to result in personal injury, death or property damage. Customer's use of this product is subject to agreement of this Authorized Use policy. In the event of an unauthorized use of Fairchild's product, Fairchild accepts no liability in the event of product failure. In other respects, this product shall be subject to Fairchild's Worldwide Terms and Conditions of Sale, unless a separate agreement has been signed by both Parties.

ANTI-COUNTERFEITING POLICY

Fairchild Semiconductor Corporation's Anti-Counterfeiting Policy. Fairchild's Anti-Counterfeiting Policy is also stated on our external website, www.fairchildsemi.com, under Terms of Use

Counterfeiting of semiconductor parts is a growing problem in the industry. All manufacturers of semiconductor products are experiencing counterfeiting of their parts. Customers who inadvertently purchase counterfeit parts experience many problems such as loss of brand reputation, substandard performance, failed applications, and increased cost of production and manufacturing delays. Fairchild is taking strong measures to protect ourselves and our customers from the proliferation of counterfeit parts. Fairchild strongly encourages customers to purchase Fairchild parts either directly from Fairchild or from Authorized Fairchild Distributors who are listed by country on our web page cited above. Products customers buy either from Fairchild directly or from Authorized Fairchild Distributors are genuine parts, have full traceability, meet Fairchild's quality standards for handling and storage and provide access to Fairchild's full range of up-to-date technical and product information. Fairchild and our Authorized Distributors will stand behind all warranties and will appropriately address any warranty issues that may arise. Fairchild will not provide any warranty coverage or other assistance for parts bought from Unauthorized Sources. Fairchild is committed to combat this global problem and encourage our customers to do their part in stopping this practice by buying direct or from authorized distributors.

PRODUCT STATUS DEFINITIONS

Definition of Terms

Datasheet Identification	Product Status	Definition
Advance Information	Formative / In Design	Datasheet contains the design specifications for product development. Specifications may change in any manner without notice.
Preliminary	First Production	Datasheet contains preliminary data; supplementary data will be published at a later date. Fairchild Semiconductor reserves the right to make changes at any time without notice to improve design.
No Identification Needed	Full Production	Datasheet contains final specifications. Fairchild Semiconductor reserves the right to make changes at any time without notice to improve the design.
Obsolete	Not In Production	Datasheet contains specifications on a product that is discontinued by Fairchild Semiconductor. The datasheet is for reference information only.

Rev. I77

ON Semiconductor and  are trademarks of Semiconductor Components Industries, LLC dba ON Semiconductor or its subsidiaries in the United States and/or other countries. ON Semiconductor owns the rights to a number of patents, trademarks, copyrights, trade secrets, and other intellectual property. A listing of ON Semiconductor's product/patent coverage may be accessed at www.onsemi.com/site/pdf/Patent-Marking.pdf. ON Semiconductor reserves the right to make changes without further notice to any products herein. ON Semiconductor makes no warranty, representation or guarantee regarding the suitability of its products for any particular purpose, nor does ON Semiconductor assume any liability arising out of the application or use of any product or circuit, and specifically disclaims any and all liability, including without limitation special, consequential or incidental damages. Buyer is responsible for its products and applications using ON Semiconductor products, including compliance with all laws, regulations and safety requirements or standards, regardless of any support or applications information provided by ON Semiconductor. "Typical" parameters which may be provided in ON Semiconductor data sheets and/or specifications can and do vary in different applications and actual performance may vary over time. All operating parameters, including "Typicals" must be validated for each customer application by customer's technical experts. ON Semiconductor does not convey any license under its patent rights nor the rights of others. ON Semiconductor products are not designed, intended, or authorized for use as a critical component in life support systems or any FDA Class 3 medical devices or medical devices with a same or similar classification in a foreign jurisdiction or any devices intended for implantation in the human body. Should Buyer purchase or use ON Semiconductor products for any such unintended or unauthorized application, Buyer shall indemnify and hold ON Semiconductor and its officers, employees, subsidiaries, affiliates, and distributors harmless against all claims, costs, damages, and expenses, and reasonable attorney fees arising out of, directly or indirectly, any claim of personal injury or death associated with such unintended or unauthorized use, even if such claim alleges that ON Semiconductor was negligent regarding the design or manufacture of the part. ON Semiconductor is an Equal Opportunity/Affirmative Action Employer. This literature is subject to all applicable copyright laws and is not for resale in any manner.

PUBLICATION ORDERING INFORMATION

LITERATURE FULFILLMENT:

Literature Distribution Center for ON Semiconductor
19521 E. 32nd Pkwy, Aurora, Colorado 80011 USA
Phone: 303-675-2175 or 800-344-3860 Toll Free USA/Canada
Fax: 303-675-2176 or 800-344-3867 Toll Free USA/Canada
Email: orderlit@onsemi.com

N. American Technical Support: 800-282-9855 Toll Free
USA/Canada
Europe, Middle East and Africa Technical Support:
Phone: 421 33 790 2910
Japan Customer Focus Center
Phone: 81-3-5817-1050

ON Semiconductor Website: www.onsemi.com
Order Literature: <http://www.onsemi.com/orderlit>
For additional information, please contact your local
Sales Representative