



November 2010

# FOD8012

## High CMR, Bi-Directional, Logic Gate Optocoupler

### Features

- Full Duplex, Bi-Directional
- 20kV/μs Minimum Common Mode Rejection
- High Speed:
  - 15Mbit/sec Data Rate (NRZ)
  - 60ns max. Propagation Delay
  - 15ns max. Pulse Width Distortion
  - 30ns max. Propagation Delay Skew
- 3.3V and 5V CMOS Compatibility
- Extended industrial temperature range, -40 to +110°C temperature range
- Safety and regulatory approvals
  - UL1577, 3750 VAC<sub>RMS</sub> for 1 min.
  - DIN EN/IEC60747-5-2 (approval pending)

### Applications

- Industrial fieldbus communications
  - DeviceNet, CAN, RS485, RS232
- Microprocessor System Interface
  - SPI, I<sup>2</sup>C
- Programmable Logic Control
- Isolated Data Acquisition System
- Voltage Level Translator

### Description

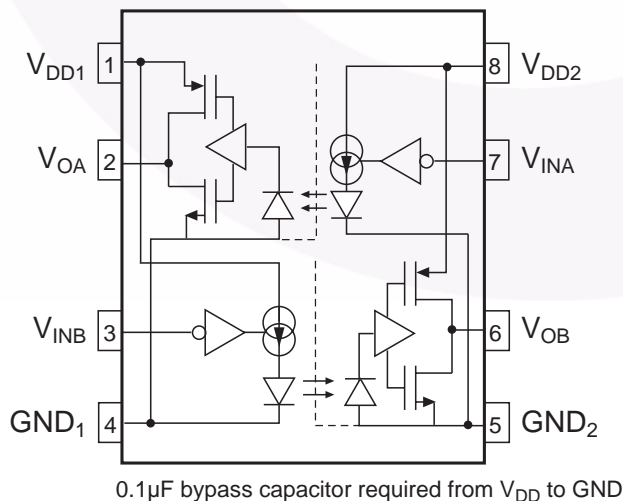
The FOD8012 is a full duplex, bi-directional, high-speed logic gate Optocoupler, which supports isolated communications allowing digital signals to communicate between systems without conducting ground loops or hazardous voltages. It utilizes Fairchild's proprietary coplanar packaging technology, Optoplanar<sup>®</sup>, and opti-IC design to achieve minimum 20kV/μs Common Mode Noise Rejection (CMR) rating.

This high-speed logic gate optocoupler is highly integrated with 2 optically coupled channels arranged in bi-directional configuration, and housed in a compact 8-pin small outline package. Each optocoupler channel consists of a high-speed AlGaAs LED driven by a CMOS buffer IC coupled to a CMOS detector IC. The detector IC comprises of an integrated photodiode, a high-speed trans-impedance amplifier and a voltage comparator with an output driver. The CMOS technology coupled to the high efficiency of the LED achieves low power consumption as well as very high speed (60ns propagation delay, 15ns pulse width distortion).

### Related Resources

- [FOD8001, High Noise Immunity, 3.3V/5V Logic Gate Optocoupler Datasheet](#)
- [www.fairchildsemi.com/products/opto/](http://www.fairchildsemi.com/products/opto/)

### Functional Schematic



Truth Table

VIN	LED	VO
High	OFF	High
Low	ON	Low

## Pin Definitions

Pin Number	Pin Name	Description
1	V <sub>DD1</sub>	<b>Supply Voltage</b> to Channel-A detector IC and Channel-B buffer IC
2	V <sub>OA</sub>	<b>Output Voltage</b> from Channel-A detector IC
3	V <sub>INB</sub>	<b>Input Voltage</b> to Channel-B buffer IC
4	GND <sub>1</sub>	<b>Ground</b> for Channel-A detector IC and Channel-B buffer IC
5	GND <sub>2</sub>	<b>Ground</b> for Channel-A buffer IC and Channel-B detector IC
6	V <sub>OB</sub>	<b>Output Voltage</b> from Channel-B detector IC
7	V <sub>INA</sub>	<b>Input Voltage</b> to Channel-A buffer IC
8	V <sub>DD2</sub>	<b>Supply Voltage</b> to Channel-A buffer IC and Channel-B detector IC

## Absolute Maximum Ratings (T<sub>A</sub>=25°C unless otherwise specified)

Stresses exceeding the absolute maximum ratings may damage the device. The device may not function or be operable above the recommended operating conditions and stressing the parts to these levels is not recommended. In addition, extended exposure to stresses above the recommended operating conditions may affect device reliability. The absolute maximum ratings are stress ratings only.

Symbol	Parameter	Value	Units
T <sub>STG</sub>	Storage Temperature	-40 to +125	°C
T <sub>OPR</sub>	Operating Temperature	-40 to +110	°C
T <sub>J</sub>	Junction Temperature	-40 to +130	°C
T <sub>SOL</sub>	Lead Solder Temperature (Refer to Reflow Temperature Profile)	260 for 10sec	°C
V <sub>DD1</sub> , V <sub>DD2</sub>	Supply Voltage	0 to 6.0	V
V <sub>IA</sub> , V <sub>IB</sub>	Input Voltage	-0.5 to VDD+0.5	V
I <sub>IA</sub> , I <sub>IB</sub>	Input DC Current	-10 to +10	µA
V <sub>OA</sub> , V <sub>OB</sub>	Output Voltage	-0.5 to VDD+0.5	V
I <sub>OA</sub> , I <sub>OB</sub>	Average Output Current	10	mA
PD <sub>I</sub>	Input Power Dissipation <sup>(1)</sup>	60	mW
PD <sub>O</sub>	Output Power Dissipation <sup>(1)</sup>	60	mW

## Recommended Operating Conditions

The Recommended Operating Conditions table defines the conditions for actual device operation. Recommended operating conditions are specified to ensure optimal performance to the datasheet specifications. Fairchild does not recommend exceeding them or designing to Absolute Maximum Ratings.

Symbol	Parameter	Min.	Max.	Unit
T <sub>A</sub>	Ambient Operating Temperature	-40	+110	°C
V <sub>DD1</sub> , V <sub>DD2</sub>	Supply Voltages (3.3V Operation) <sup>(2)</sup>	3.0	3.6	V
	Supply Voltages (5.0V Operation) <sup>(2)</sup>	4.5	5.5	V
V <sub>IH</sub>	Logic High Input Voltage	2.0	V <sub>DD</sub>	V
V <sub>IL</sub>	Logic Low Input Voltage	0	0.8	V
t <sub>r</sub> , t <sub>f</sub>	Input Signal Rise and Fall Time		1.0	ms

## Isolation Characteristics

Apply over all recommended conditions, typical value is measured at  $T_A = 25^\circ\text{C}$

Symbol	Parameter	Conditions	Min.	Typ.	Max.	Units
$V_{ISO}$	Input-Output Isolation Voltage	freq = 60Hz, t = 1.0min, $I_{I-O} \leq 10\mu\text{A}^{(3)(4)}$	3750			V <sub>aCRMS</sub>
$R_{ISO}$	Isolation Resistance	$V_{I-O} = 500\text{V}^{(3)}$	$10^{11}$			$\Omega$
$C_{ISO}$	Isolation Capacitance	$V_{I-O} = 0\text{V}$ , freq = 1.0MHz <sup>(3)</sup>		0.2		pF

## Electrical Characteristics

$T_A = -40^\circ\text{C}$  to  $+110^\circ\text{C}$ ,  $3.0\text{V} \leq V_{DD} \leq 5.5\text{V}$ , unless otherwise specified.

Apply over all recommended conditions, typical value is measured at  $V_{DD1} = V_{DD2} = +3.3\text{V}$ ,  $T_A = 25^\circ\text{C}$

Symbol	Parameter	Conditions	Min.	Typ.	Max.	Units
$I_{DD1L}, I_{DD2L}$	Logic Low Supply Current	$V_{IA}, V_{IB} = 0\text{V}$		5.8	8.0	mA
$I_{DD1H}, I_{DD2H}$	Logic High Supply Current	$V_{IA}, V_{IB} = V_{DD}$		2.5	4.0	mA
$I_{IA}, I_{IB}$	Input Current		-10		+10	$\mu\text{A}$
$V_{OH}$	Logic High Output Voltage	$I_O = -20\mu\text{A}$ , $V_{DD} = 3.3\text{V}$ , $V_I = V_{IH}$	3.2	3.3		V
		$I_O = -4\text{mA}$ , $V_{DD} = 3.3\text{V}$ , $V_I = V_{IH}$	3.0	3.1		V
		$I_O = -20\mu\text{A}$ , $V_{DD} = 5\text{V}$ , $V_I = V_{IH}$	4.9	5.0		V
		$I_O = -4\text{mA}$ , $V_{DD} = 5\text{V}$ , $V_I = V_{IH}$	4.7	4.8		V
$V_{OL}$	Logic Low Output Voltage	$I_O = 20\mu\text{A}$ , $V_{DD} = 3.3\text{V}$ or $5\text{V}$ , $V_I = V_{IL}$		0	0.1	V
		$I_O = 4\text{mA}$ , $V_{DD} = 3.3\text{V}$ or $5\text{V}$ , $V_I = V_{IL}$		0.26	0.6	V

## Switching Characteristics

$T_A = -40^\circ\text{C}$  to  $+110^\circ\text{C}$ ,  $3.0\text{V} \leq V_{DD} \leq 5.5\text{V}$ , unless otherwise specified.

Apply over all recommended conditions, typical value is measured at  $V_{DD1} = V_{DD2} = +3.3\text{V}$ ,  $T_A = 25^\circ\text{C}$

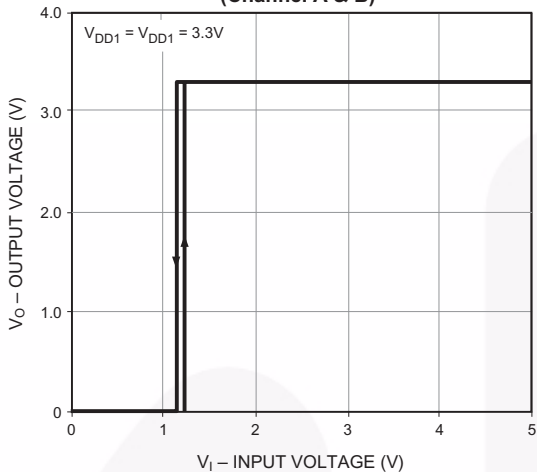
Symbol	Parameter	Conditions	Min.	Typ.	Max.	Units
Data Rate					15	Mbit/s
$t_{PHL}$	Propagation Delay Time to Logic Low Output	$PW = 66.7\text{ns}$ , $C_L = 15\text{pF}$		37	60	ns
$t_{PLH}$	Propagation Delay Time to Logic High Output	$PW = 66.7\text{ns}$ , $C_L = 15\text{pF}$		40	60	ns
PWD	Pulse Width Distortion, $ t_{PHL} - t_{PLH} $	$PW = 66.7\text{ns}$ , $C_L = 15\text{pF}^{(5)}$		3	15	ns
$t_{PSK(CC)}$	Channel-Channel Skew	$PW = 66.7\text{ns}$ , $C_L = 15\text{pF}^{(6)}$		12	25	ns
$t_{PSK(PP)}$	Part-Part Skew	$PW = 66.7\text{ns}$ , $C_L = 15\text{pF}^{(7)}$			30	ns
$t_R$	Output Rise Time (10% to 90%)	$PW = 66.7\text{ns}$ , $C_L = 15\text{pF}$		6.5		ns
$t_F$	Output Fall Time (90% to 10%)	$PW = 66.7\text{ns}$ , $C_L = 15\text{pF}$		6.5		ns
$ CM_H $	Common Mode Transient Immunity at Output High	$V_I = V_{DD1}$ , $V_O > 0.8V_{DD1}$ , $V_{CM} = 1000\text{V}^{(8)}$	20	40		kV/ $\mu\text{s}$
$ CM_L $	Common Mode Transient Immunity at Output Low	$V_I = 0\text{V}$ , $V_O < 0.8\text{V}$ , $V_{CM} = 1000\text{V}^{(8)}$	20	40		kV/ $\mu\text{s}$

### Notes:

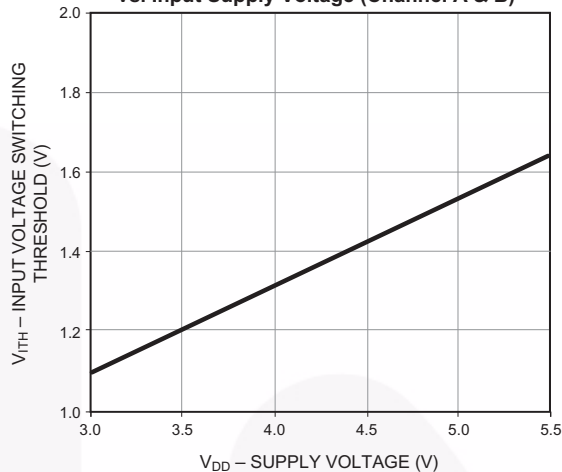
- No derating required.
- 0.1 $\mu\text{F}$  bypass capacitor must be connected between Pin 1 and 4, and 5 and 8. The capacitors should be kept close to the supply pins.
- Device is considered a two terminal device: Pins 1, 2, 3 and 4 are shorted together and Pins 5, 6, 7 and 8 are shorted together.
- 3,750  $V_{AC_{RMS}}$  for 1 minute duration is equivalent to 4,500  $V_{AC_{RMS}}$  for 1 second duration.
- PWD is equal to the magnitude of the worst case difference in  $t_{PHL}$  and/or  $t_{PLH}$  that will be seen for one channel switching, while holding the other channel output at a low or high state, or while both channels are in synchronous data transmission mode.
- $t_{PSK(CC)}$  is equal to the magnitude of the worst case difference in  $t_{PHL}$  and/or  $t_{PLH}$  that will be seen between the two channels within a single device.
- $t_{PSK(PP)}$  is equal to the magnitude of the worst case difference in  $t_{PHL}$  and/or  $t_{PLH}$  that will be seen between any two units from the same manufacturing date code that are operated at same case temperature, at same operating conditions, with equal loads.
- Common mode transient immunity at output high is the maximum tolerable positive  $dV_{cm}/dt$  on the leading edge of the common mode impulse signal,  $V_{cm}$ , to assure that the output will remain high. Common mode transient immunity at output low is the maximum tolerable negative  $dV_{cm}/dt$  on the trailing edge of the common pulse signal,  $V_{cm}$ , to assure that the output will remain low.

## Typical Performance Curves

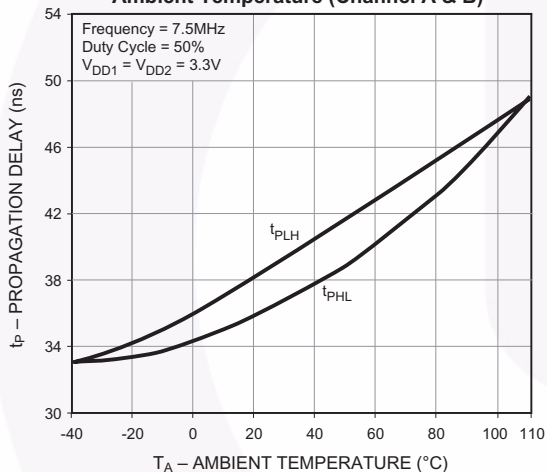
**Fig. 1 Typical Output Voltage vs. Input Voltage (Channel A & B)**



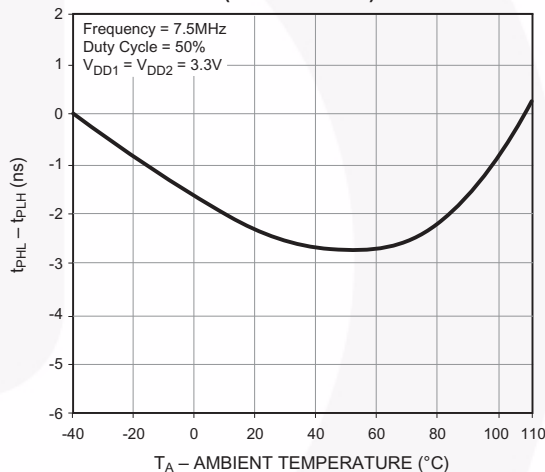
**Fig. 2 Typical Input Voltage Switching Threshold vs. Input Supply Voltage (Channel A & B)**



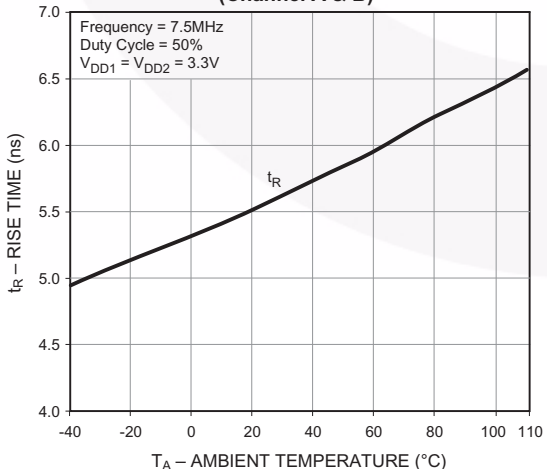
**Fig. 3 Typical Propagation Delay vs. Ambient Temperature (Channel A & B)**



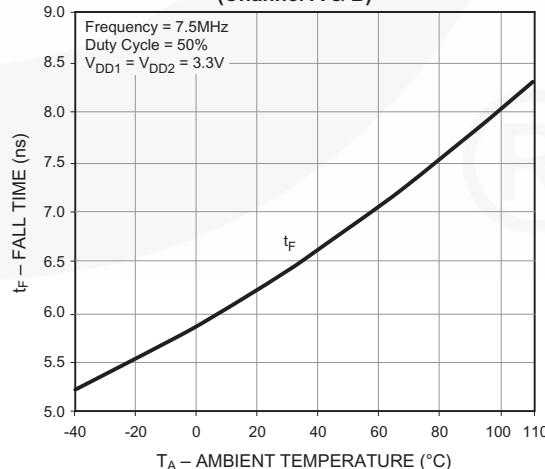
**Fig. 4 Typical  $t_{PHL} - t_{PLH}$  vs. Ambient Temperature (Channel A & B)**



**Fig. 5 Typical Rise Time vs. Ambient Temperature (Channel A & B)**

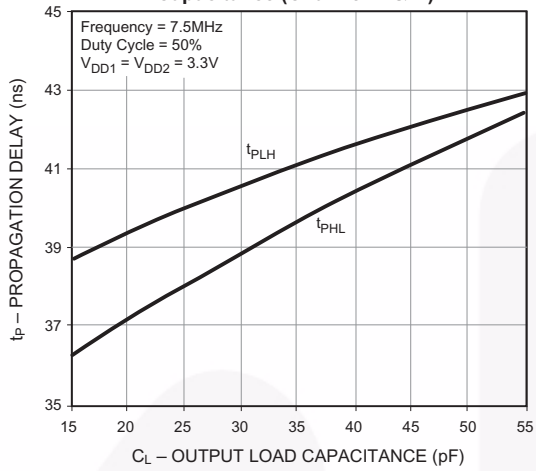


**Fig. 6 Typical Fall Time vs. Ambient Temperature (Channel A & B)**

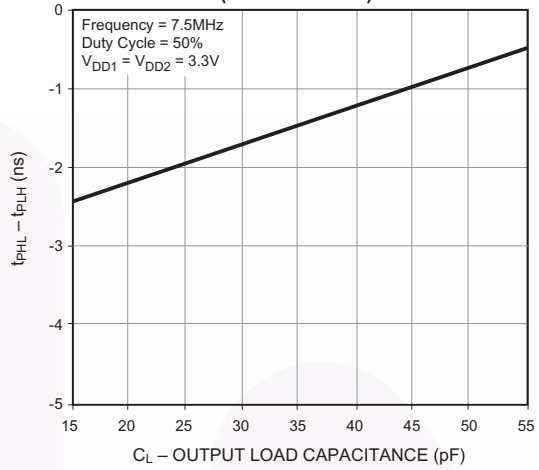


## Typical Performance Curves (Continued)

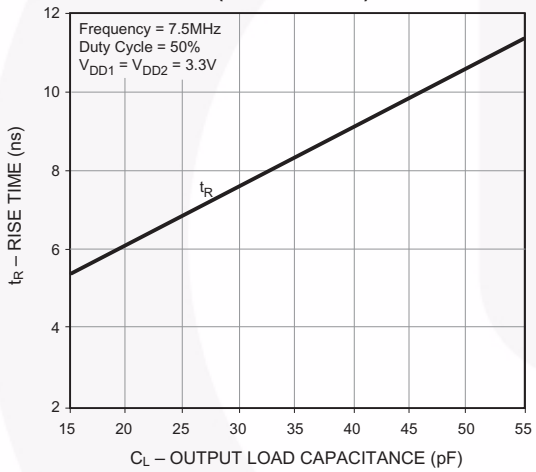
**Fig. 7 Typical Propagation Delay vs. Output Load Capacitance (Channel A & B)**



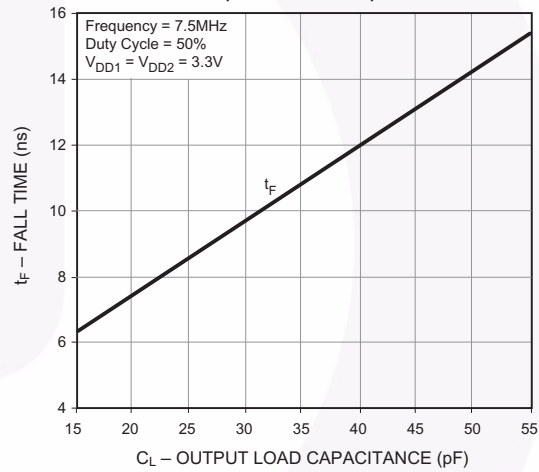
**Fig. 8 Typical  $t_{PHL} - t_{PLH}$  vs. Output Load Capacitance (Channel A & B)**



**Fig. 9 Typical Rise Time vs. Output Load Capacitance (Channel A & B)**

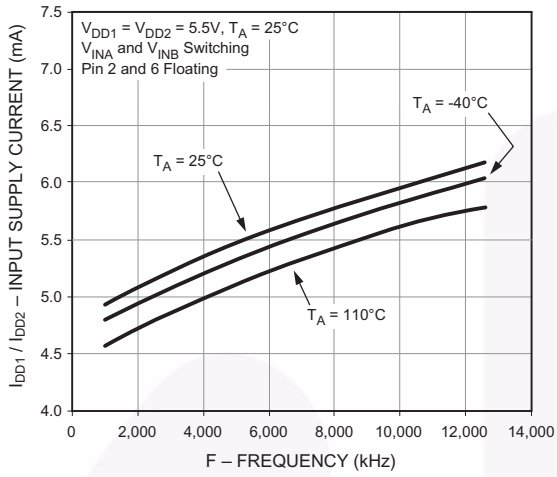


**Fig. 10 Typical Fall Time vs. Output Load Capacitance (Channel A & B)**

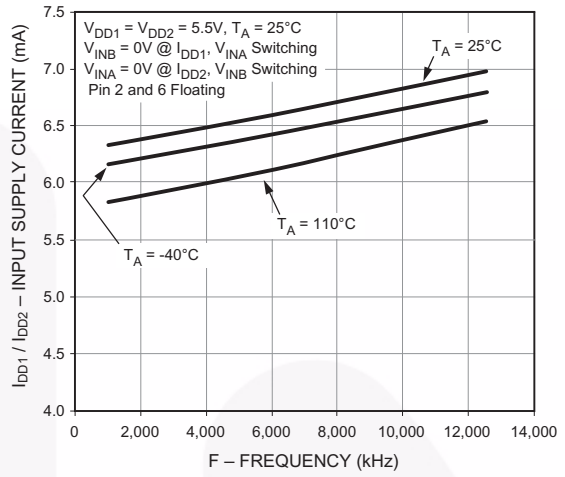


## Typical Performance Curves (Continued)

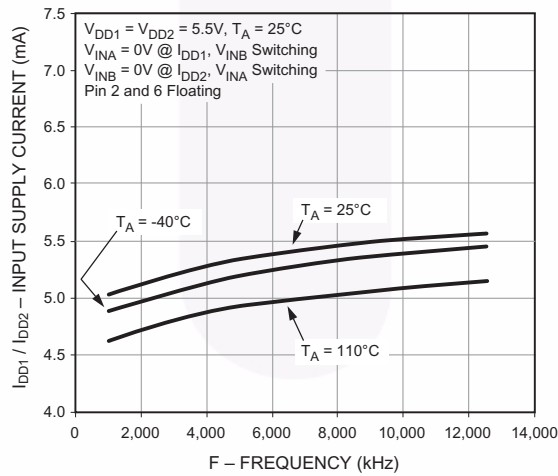
**Fig. 11a Typical  $I_{DD1}/I_{DD2}$  Supply Current vs. Frequency**



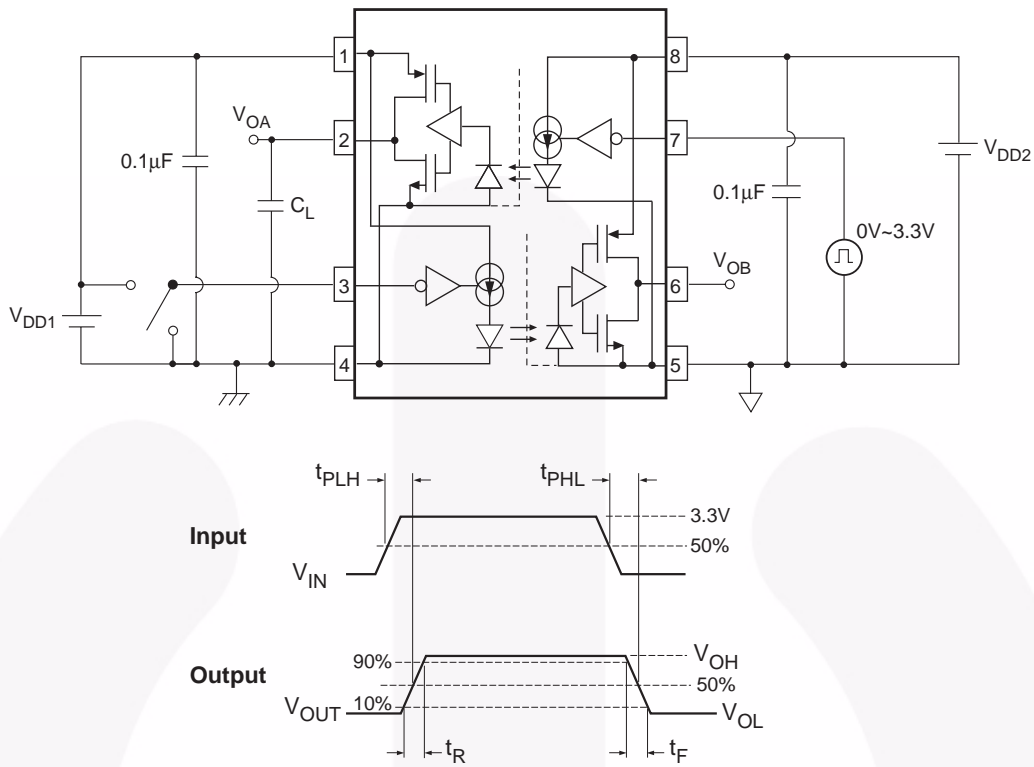
**Fig. 11b Typical  $I_{DD1}/I_{DD2}$  Supply Current vs. Frequency**



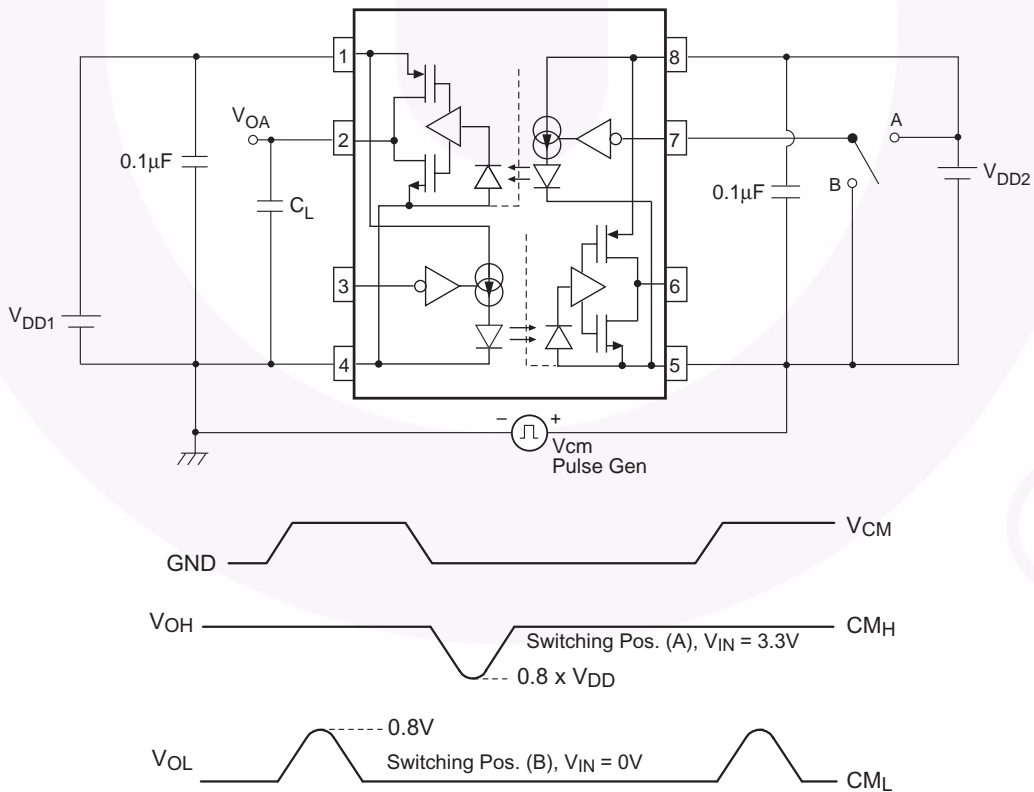
**Fig. 11c Typical  $I_{DD1}/I_{DD2}$  Supply Current vs. Frequency**



### Test Circuits



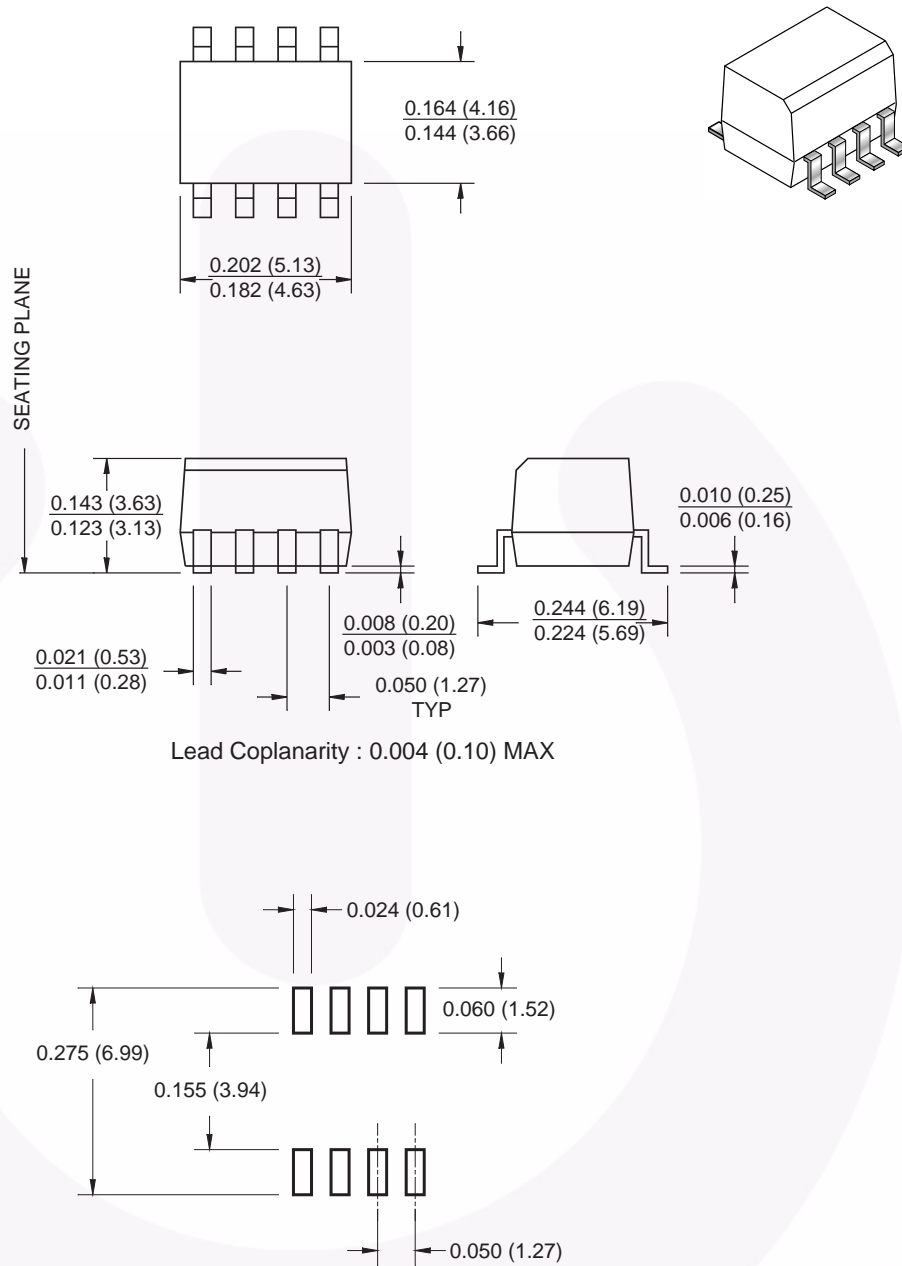
**Figure 11. Test Circuit for Propagation Delay Time and Rise Time, Fall Time**



**Figure 12. Test Circuit for Instantaneous Common Mode Rejection Voltage**



## Small Outline Package Dimensions



### Note:

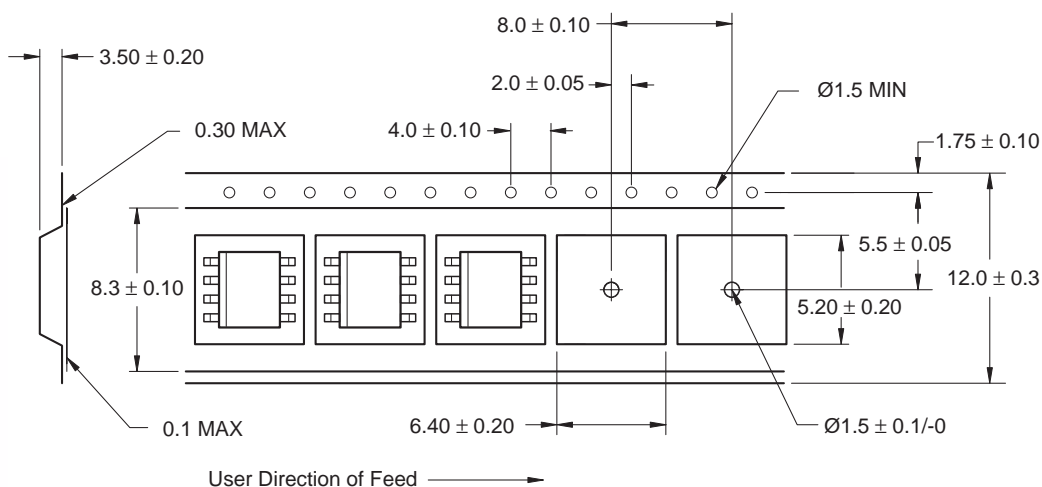
All dimensions are in millimeters.

Package drawings are provided as a service to customers considering Fairchild components. Drawings may change in any manner without notice. Please note the revision and/or date on the drawing and contact a Fairchild Semiconductor representative to verify or obtain the most recent revision. Package specifications do not expand the terms of Fairchild's worldwide terms and conditions, specifically the warranty therein, which covers Fairchild products.

Always visit Fairchild Semiconductor's online packaging area for the most recent package drawings:

<http://www.fairchildsemi.com/packaging/>

### Carrier Tape Specification



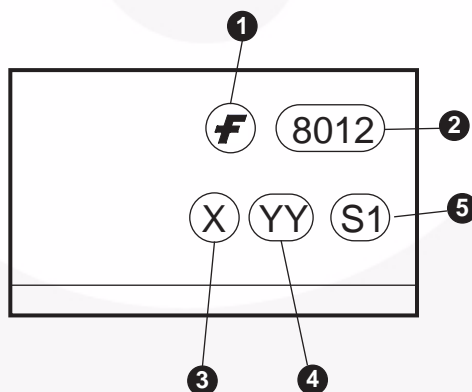
**Note:**  
All dimensions are in millimeters.

### Ordering Information

Option	Order Entry Identifier	Description
No Suffix	FOD8012	Small outline 8-pin, shipped in tubes (50 units per tube)
R2	FOD8012R2	Small outline 8-pin, tape and reel (2,500 units per reel)

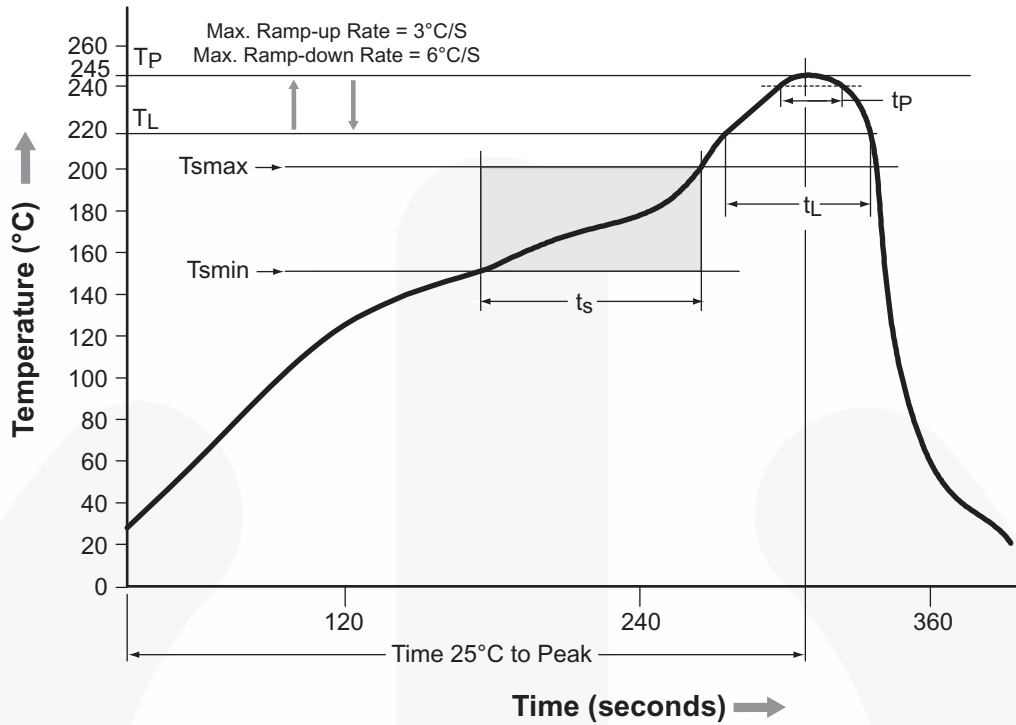
All packages are lead free per JEDEC: J-STD-020B standard.

### Marking Information



Definitions	
1	Fairchild logo
2	Device number
3	One digit year code, e.g., '8'
4	Two digit work week ranging from '01' to '53'
5	Assembly package code

### Reflow Profile








Profile Feature	Pb-Free Assembly Profile
Temperature Min. (T <sub>smin</sub> )	150°C
Temperature Max. (T <sub>smax</sub> )	200°C
Time (t <sub>s</sub> ) from (T <sub>smin</sub> to T <sub>smax</sub> )	60–120 seconds
Ramp-up Rate (t <sub>L</sub> to t <sub>p</sub> )	3°C/second max.
Liquidous Temperature (T <sub>L</sub> )	217°C
Time (t <sub>L</sub> ) Maintained Above (T <sub>L</sub> )	60–150 seconds
Peak Body Package Temperature	245°C +0°C / -5°C
Time (t <sub>p</sub> ) within 5°C of 245°C	30 seconds
Ramp-down Rate (T <sub>P</sub> to T <sub>L</sub> )	6°C/second max.
Time 25°C to Peak Temperature	8 minutes max.



## TRADEMARKS

The following includes registered and unregistered trademarks and service marks, owned by Fairchild Semiconductor and/or its global subsidiaries, and is not intended to be an exhaustive list of all such trademarks.

AccuPower™	F-PFS™		
AX-CAP®*	FRFET®	PowerTrench®	TinyBoost®
BitSiC™	Global Power Resource <sup>SM</sup>	PowerXS™	TinyBuck®
Build it Now™	GreenBridge™	Programmable Active Droop™	TinyCalc™
CorePLUS™	Green FPS™	QFET®	TinyLogic®
CorePOWER™	Green FPS™ e-Series™	QS™	TINYOPTO™
CROSSVOL™	Gmax™	Quiet Series™	TinyPower™
CTL™	GTO™	RapidConfigure™	TinyPWM™
Current Transfer Logic™	IntelliMAX™		TinyWire™
DEUXPEED®	ISOPLANAR™	Saving our world, 1mW/W/kW at a time™	TranSiC™
Dual Cool™	Making Small Speakers Sound Louder and Better™	SignalWise™	TriFault Detect™
EcoSPARK®	MegaBuck™	SmartMax™	TRUECURRENT®*
EfficientMax™	MICROCOUPLER™	SMART START™	μSerDes™
ESBC™	MicroFET™	Solutions for Your Success™	
	MicroPak™	SPM®	UHC®
Fairchild®	MicroPak2™	STEALTH™	Ultra FRFET™
Fairchild Semiconductor®	MillerDrive™	SuperFET®	UniFET™
FACT Quiet Series™	MotionMax™	SuperSOT™-3	VXC™
FACT®	mWSaver®	SuperSOT™-6	VisualMax™
FAST®	OptoHiT™	SuperSOT™-8	VoltagePlus™
FastvCore™	OPTOLOGIC®	SupreMOS®	XS™
FETBench™	OPTOPLANAR®	SyncFET™	仙童™
FPS™		Sync-Lock™	

\* Trademarks of System General Corporation, used under license by Fairchild Semiconductor.

## DISCLAIMER

FAIRCHILD SEMICONDUCTOR RESERVES THE RIGHT TO MAKE CHANGES WITHOUT FURTHER NOTICE TO ANY PRODUCTS HEREIN TO IMPROVE RELIABILITY, FUNCTION, OR DESIGN. FAIRCHILD DOES NOT ASSUME ANY LIABILITY ARISING OUT OF THE APPLICATION OR USE OF ANY PRODUCT OR CIRCUIT DESCRIBED HEREIN; NEITHER DOES IT CONVEY ANY LICENSE UNDER ITS PATENT RIGHTS, NOR THE RIGHTS OF OTHERS. THESE SPECIFICATIONS DO NOT EXPAND THE TERMS OF FAIRCHILD'S WORLDWIDE TERMS AND CONDITIONS, SPECIFICALLY THE WARRANTY THEREIN, WHICH COVERS THESE PRODUCTS.

## LIFE SUPPORT POLICY

FAIRCHILD'S PRODUCTS ARE NOT AUTHORIZED FOR USE AS CRITICAL COMPONENTS IN LIFE SUPPORT DEVICES OR SYSTEMS WITHOUT THE EXPRESS WRITTEN APPROVAL OF FAIRCHILD SEMICONDUCTOR CORPORATION.

As used herein:

1. Life support devices or systems are devices or systems which, (a) are intended for surgical implant into the body or (b) support or sustain life, and (c) whose failure to perform when properly used in accordance with instructions for use provided in the labeling, can be reasonably expected to result in a significant injury of the user.
2. A critical component in any component of a life support, device, or system whose failure to perform can be reasonably expected to cause the failure of the life support device or system, or to affect its safety or effectiveness.

## ANTI-COUNTERFEITING POLICY

Fairchild Semiconductor Corporation's Anti-Counterfeiting Policy. Fairchild's Anti-Counterfeiting Policy is also stated on our external website, [www.fairchildsemi.com](http://www.fairchildsemi.com), under Sales Support.

Counterfeiting of semiconductor parts is a growing problem in the industry. All manufacturers of semiconductor products are experiencing counterfeiting of their parts. Customers who inadvertently purchase counterfeit parts experience many problems such as loss of brand reputation, substandard performance, failed applications, and increased cost of production and manufacturing delays. Fairchild is taking strong measures to protect ourselves and our customers from the proliferation of counterfeit parts. Fairchild strongly encourages customers to purchase Fairchild parts either directly from Fairchild or from Authorized Fairchild Distributors who are listed by country on our web page cited above. Products customers buy either from Fairchild directly or from Authorized Fairchild Distributors are genuine parts, have full traceability, meet Fairchild's quality standards for handling and storage and provide access to Fairchild's full range of up-to-date technical and product information. Fairchild and our Authorized Distributors will stand behind all warranties and will appropriately address any warranty issues that may arise. Fairchild will not provide any warranty coverage or other assistance for parts bought from Unauthorized Sources. Fairchild is committed to combat this global problem and encourage our customers to do their part in stopping this practice by buying direct or from authorized distributors.

## PRODUCT STATUS DEFINITIONS

### Definition of Terms

Datasheet Identification	Product Status	Definition
Advance Information	Formative / In Design	Datasheet contains the design specifications for product development. Specifications may change in any manner without notice.
Preliminary	First Production	Datasheet contains preliminary data; supplementary data will be published at a later date. Fairchild Semiconductor reserves the right to make changes at any time without notice to improve design.
No Identification Needed	Full Production	Datasheet contains final specifications. Fairchild Semiconductor reserves the right to make changes at any time without notice to improve the design.
Obsolete	Not In Production	Datasheet contains specifications on a product that is discontinued by Fairchild Semiconductor. The datasheet is for reference information only.

Rev. I68