

74F04 Hex Inverter

General Description

This device contains six independent gates, each of which performs the logic INVERT function.

Ordering Code:

Order Number	Package Number	Package Description
74F04SC	M14A	14-Lead Small Outline Integrated Circuit (SOIC), JEDEC MS-120, 0.150 Narrow
74F04SJ	M14D	14-Lead Small Outline Package (SOP), EIAJ TYPE II, 5.3mm Wide
74F04PC	N14A	14-Lead Plastic Dual-In-Line Package (PDIP), JEDEC MS-001, 0.300 Wide

Devices also available in Tape and Reel. Specify by appending the suffix letter "X" to the ordering code.

Logic Symbol

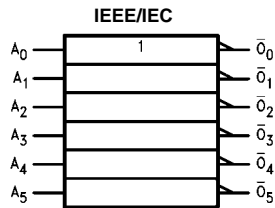

Connection Diagram

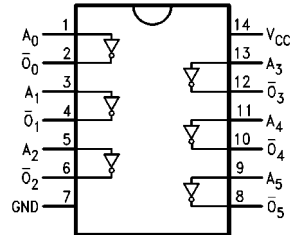

Unit Loading/Fan Out

Pin Names	Description	U.L. HIGH/LOW	Input I_H/I_L Output I_{OH}/I_{OL}
A_n	Inputs	1.0/1.0	20 μ A/-0.6 mA
\bar{O}_n	Outputs	50/33.3	-1 mA/20 mA

Absolute Maximum Ratings (Note 1)

Storage Temperature	-65°C to +150°C
Ambient Temperature under Bias	-55°C to +125°C
Junction Temperature under Bias	-55°C to +150°C
V _{CC} Pin Potential to Ground Pin	-0.5V to +7.0V
Input Voltage (Note 2)	-0.5V to +7.0V
Input Current (Note 2)	-30 mA to +5.0 mA
Voltage Applied to Output in HIGH State (with V _{CC} = 0V)	
Standard Output	-0.5V to V _{CC}
3-STATE Output	-0.5V to +5.5V
Current Applied to Output in LOW State (Max)	twice the rated I _{OL} (mA)
ESD Last Passing Voltage (Min)	4000V

Recommended Operating Conditions

Free Air Ambient Temperature	0°C to +70°C
Supply Voltage	+4.5V to +5.5V

Note 1: Absolute maximum ratings are values beyond which the device may be damaged or have its useful life impaired. Functional operation under these conditions is not implied.

Note 2: Either voltage limit or current limit is sufficient to protect inputs.

DC Electrical Characteristics

Symbol	Parameter	Min	Typ	Max	Units	V _{CC}	Conditions
V _{IH}	Input HIGH Voltage	2.0			V		Recognized as a HIGH Signal
V _{IL}	Input LOW Voltage			0.8	V		Recognized as a LOW Signal
V _{CD}	Input Clamp Diode Voltage			-1.2	V	Min	I _{IN} = -18 mA
V _{OH}	Output HIGH Voltage	10% V _{CC}	2.5			Min	I _{OH} = -1 mA
		5% V _{CC}	2.7				I _{OH} = -1 mA
V _{OL}	Output LOW Voltage	10% V _{CC}		0.5	V	Min	I _{OL} = 20 mA
I _{IH}	Input HIGH Current			5.0	μA	Max	V _{IN} = 2.7V
I _{BVI}	Input HIGH Current Breakdown Test			7.0	μA	Max	V _{IN} = 7.0V
I _{CEX}	Output HIGH Leakage Current			50	μA	Max	V _{OUT} = V _{CC}
V _{ID}	Input Leakage Test	4.75			V	0.0	I _{ID} = 1.9 μA All other pins grounded
I _{OD}	Output Leakage Circuit Current			3.75	μA	0.0	V _{IOD} = 150 mV All other pins grounded
I _{IL}	Input LOW Current			-0.6	mA	Max	V _{IN} = 0.5V
I _{OS}	Output Short-Circuit Current	-60		-150	mA	Max	V _{OUT} = 0V
I _{CCH}	Power Supply Current		2.8	4.2	mA	Max	V _O = HIGH
I _{CCL}	Power Supply Current		10.2	15.3	mA	Max	V _O = LOW

AC Electrical Characteristics

Symbol	Parameter	T _A = +25°C V _{CC} = +5.0V C _L = 50 pF			T _A = -55°C to +125°C V _{CC} = +5.0V C _L = 50 pF		T _A = 0°C to +70°C V _{CC} = +5.0V C _L = 50 pF		Units
		Min	Typ	Max	Min	Max	Min	Max	
t _{PLH}	Propagation Delay	2.4	3.7	5.0	2.0	7.0	2.4	6.0	ns
t _{PHL}	A _n to \bar{O}_n	1.5	3.2	4.3	1.5	6.5	1.5	5.3	

Physical Dimensions inches (millimeters) unless otherwise noted



**14-Lead Small Outline Integrated Circuit (SOIC), JEDEC MS-120, 0.150 Narrow
Package Number M14A**

M14A (REV. 1)

Physical Dimensions inches (millimeters) unless otherwise noted (Continued)

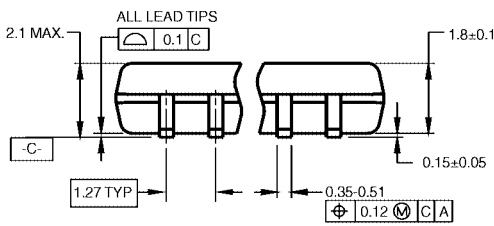

DIMENSIONS ARE IN MILLIMETERS

- NOTES:
 A. CONFORMS TO EIAJ EDR-7320 REGISTRATION, ESTABLISHED IN DECEMBER, 1998.
 B. DIMENSIONS ARE IN MILLIMETERS.
 C. DIMENSIONS ARE EXCLUSIVE OF BURRS, MOLD FLASH, AND TIE BAR EXTRUSIONS.

M14DRevB1

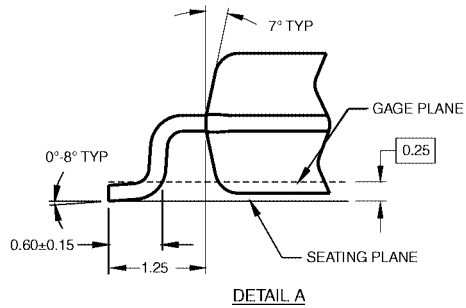
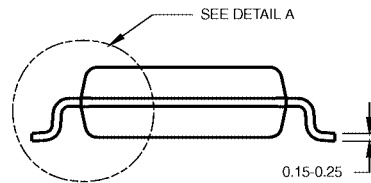

**14-Lead Small Outline Package (SOP), EIAJ TYPE II, 5.3mm Wide
 Package Number M14D**

Physical Dimensions inches (millimeters) unless otherwise noted (Continued)

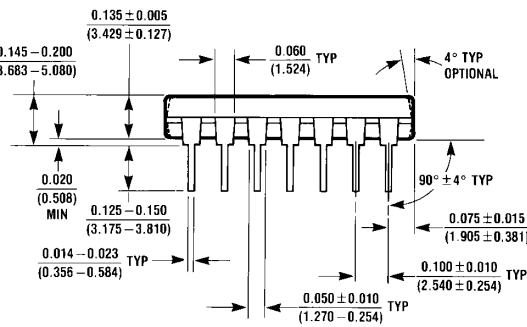
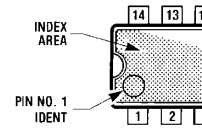
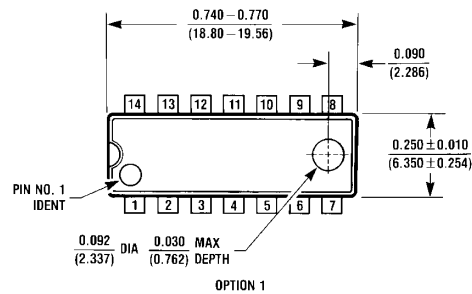

N14A (REV F)

14-Lead Plastic Dual-In-Line Package (PDIP), JEDEC MS-001, 0.300 Wide Package Number N14A

Fairchild does not assume any responsibility for use of any circuitry described, no circuit patent licenses are implied and Fairchild reserves the right at any time without notice to change said circuitry and specifications.

LIFE SUPPORT POLICY

FAIRCHILD'S PRODUCTS ARE NOT AUTHORIZED FOR USE AS CRITICAL COMPONENTS IN LIFE SUPPORT DEVICES OR SYSTEMS WITHOUT THE EXPRESS WRITTEN APPROVAL OF THE PRESIDENT OF FAIRCHILD SEMICONDUCTOR CORPORATION. As used herein:

1. Life support devices or systems are devices or systems which, (a) are intended for surgical implant into the body, or (b) support or sustain life, and (c) whose failure to perform when properly used in accordance with instructions for use provided in the labeling, can be reasonably expected to result in a significant injury to the user.
2. A critical component in any component of a life support device or system whose failure to perform can be reasonably expected to cause the failure of the life support device or system, or to affect its safety or effectiveness.

www.fairchildsemi.com