

MM74HC4538 Dual Retriggerable Monostable Multivibrator

General Description

The MM74HC4538 high speed monostable multivibrator (one shots) is implemented in advanced silicon-gate CMOS technology. They feature speeds comparable to low power Schottky TTL circuitry while retaining the low power and high noise immunity characteristic of CMOS circuits.

Each multivibrator features both a negative, A, and a positive, B, transition triggered input, either of which can be used as an inhibit input. Also included is a clear input that when taken low resets the one shot. The MM74HC4538 is retriggerable. That is, it may be triggered repeatedly while their outputs are generating a pulse and the pulse will be extended.

Pulse width stability over a wide range of temperature and supply is achieved using linear CMOS techniques. The output pulse equation is simply: $PW = 0.7(R)(C)$ where PW is in seconds, R is in ohms, and C is in farads. This device is pin compatible with the CD4528, and the CD4538 one shots. All inputs are protected from damage due to static discharge by diodes to V_{CC} and ground.

Features

- Schmitt trigger on A and B inputs
- Wide power supply range: 2–6V
- Typical trigger propagation delay: 32 ns
- Fanout of 10 LS-TTL loads
- Low input current: 1 μ A max

Ordering Code:

Order Number	Package Number	Package Description
MM74HC4538M	M16A	16-Lead Small Outline Integrated Circuit (SOIC), JEDEC MS-012, 0.150 Narrow
MM74HC4538SJ	M16D	16-Lead Small Outline Package (SOP), EIAJ TYPE II, 5.3mm Wide
MM74HC4538N	N16E	16-Lead Plastic Dual-In-Line Package (PDIP), JEDEC MS-001, 0.300 Wide

Devices also available in Tape and Reel. Specify by appending the suffix letter "X" to the ordering code.

Connection Diagram

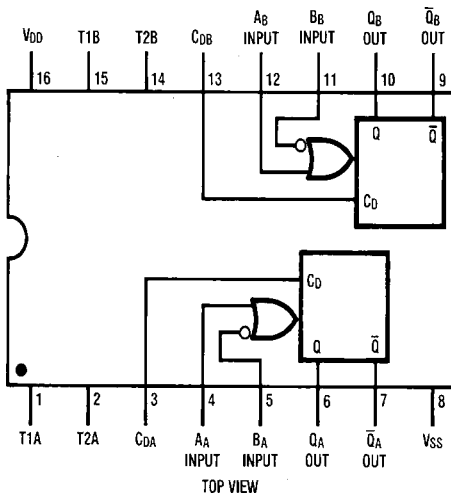

Truth Table

	Inputs		Outputs	
Clear	A	B	Q	\bar{Q}
L	X	X	L	H
X	H	X	L	H
X	X	L	L	H
H	L	↓	⌊	⌋
H	↑	H	⌊	⌋

H = HIGH Level
L = LOW Level
↑ = Transition from LOW-to-HIGH
↓ = Transition from HIGH-to-LOW
⌊ = One HIGH Level Pulse
⌋ = One LOW Level Pulse
X = Irrelevant

Block Diagrams

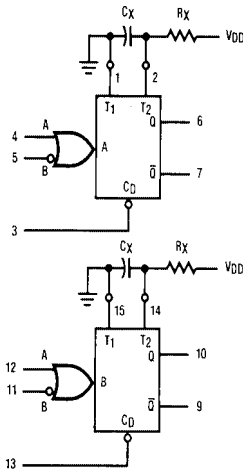

R_X AND C_X ARE EXTERNAL COMPONENTS

Note: Pin 1 and Pin 15 must be hard-wired to GND.

Logic Diagram

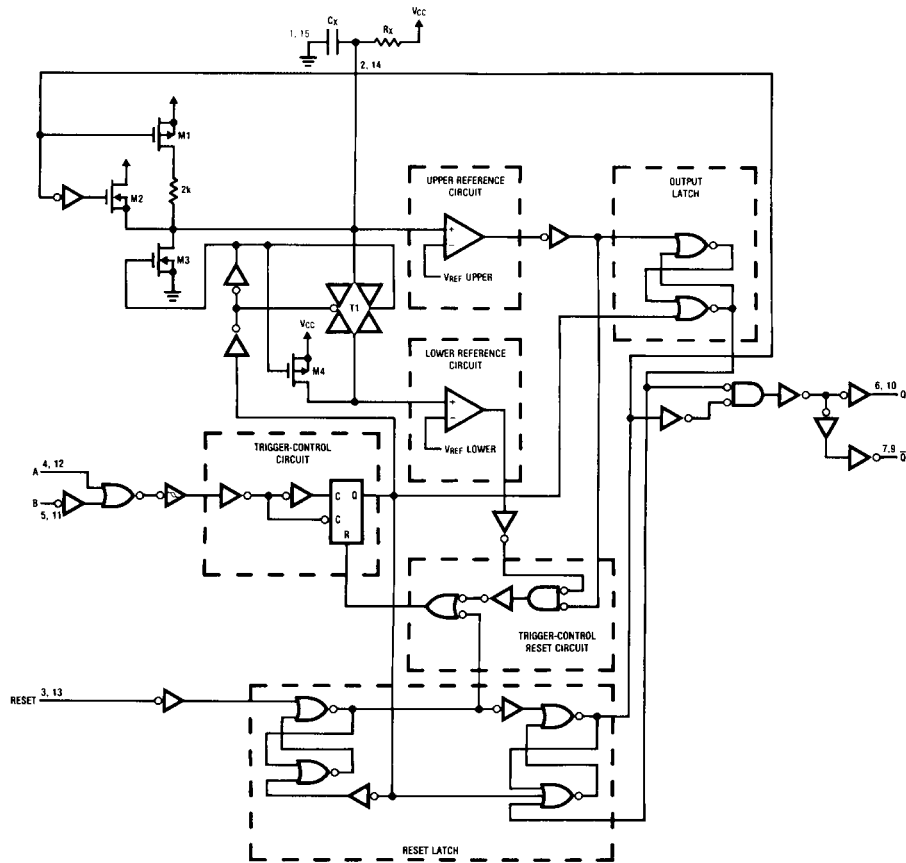

Timing Diagram

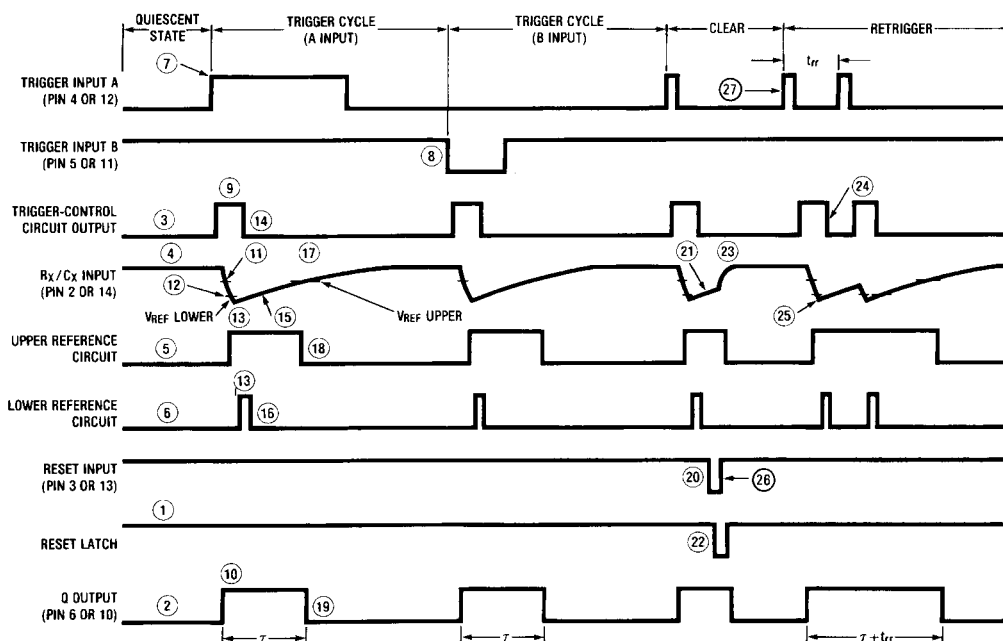

Circuit Operation

The MM74HC4538 operates as follows (refer to logic diagram). In the quiescent state, the external timing capacitor, C_X , is charged to V_{CC} . When a trigger occurs, the Q output goes HIGH and C_X discharges quickly to the lower reference voltage ($V_{REF\ Lower} = \frac{1}{3} V_{CC}$). C_X then charges, through R_X , back up to the upper reference voltage ($V_{REF\ Upper} = \frac{2}{3} V_{CC}$), at which point the one-shot has timed out and the Q output goes LOW.

The following, more detailed description of the circuit operation refers to both the logic diagram and the timing diagram.

QUIESCENT STATE

In the quiescent state, before an input trigger appears, the output latch is HIGH and the reset latch is HIGH (#1 in logic diagram).

Thus the Q output (pin 6 or 10) of the monostable multivibrator is LOW (#2, timing diagram).

The output of the trigger-control circuit is LOW (#3), and transistors M1, M2, and M3 are turned off. The external timing capacitor, C_X , is charged to V_{CC} (#4), and the upper reference circuit has a LOW output (#5). Transistor M4 is turned ON and transmission gate T1 is turned OFF. Thus the lower reference circuit has V_{CC} at the noninverting input and a resulting LOW output (#6).

In addition, the output of the trigger-control reset circuit is LOW.

TRIGGER OPERATION

The MM74HC4538 is triggered by either a rising-edge signal at input A (#7) or a falling-edge signal at input B (#8), with the unused trigger input and the Reset input held at the voltage levels shown in the Truth Table. Either trigger signal will cause the output of the trigger-control circuit to go HIGH (#9).

The trigger-control circuit going HIGH simultaneously initiates three events. First, the output latch goes LOW, thus taking the Q output of the HC4538 to a HIGH State (#10). Second, transistor M3 is turned on, which allows the external timing capacitor, C_X , to rapidly discharge toward ground (#11). (Note that the voltage across C_X appears at the input of the upper reference circuit comparator.) Third, transistor M4 is turned off and transmission gate T1 is turned ON, thus allowing the voltage across C_X to also appear at the input of the lower reference circuit comparator.

When C_X discharges to the reference voltage of the lower reference circuit (#12), the outputs of both reference circuits will be HIGH (#13). The trigger-control reset circuit goes HIGH, resetting the trigger-control circuit flip-flop to a LOW State (#14). This turns transistor M3 OFF again, allowing C_X to begin to charge back up toward V_{CC} , with a time constant $t = R_X C_X$ (#15). In addition, transistor M4 is turned ON and transmission gate T1 is turned OFF. Thus a high voltage level is applied to the input of the lower reference circuit comparator, causing its output to go LOW (#16). The monostable multivibrator may be retriggered at any time after the trigger-control circuit goes LOW.

When C_X charges up to the reference voltage of the upper reference circuit (#17), the output of the upper reference circuit goes LOW (#18). This causes the output latch to

Circuit Operation (Continued)

toggle, taking the Q output of the HC4538 to a LOW State (#19), and completing the time-out cycle.

RESET OPERATION

A low voltage applied to the Reset pin always forces the Q output of the HC4538 to a LOW State.

The timing diagram illustrates the case in which reset occurs (#20) while C_X is charging up toward the reference voltage of the upper reference circuit (#21). When a reset occurs, the output of the reset latch goes LOW (#22), turning ON transistor M1. Thus C_X is allowed to quickly charge up to V_{CC} (#23) to await the next trigger signal.

Recovery time is the required delay after reset goes inactive to a new trigger rising edge. On the diagram it is shown as (#26) to (#27).

RETRIGGER OPERATION

In the retriggerable mode, the HC4538 may be retriggered during timing out of the output pulse at any time after the trigger-control circuit flip-flop has been reset (#24). Because the trigger-control circuit flip-flop resets shortly after C_X has discharged to the reference voltage of the lower reference circuit (#25), the minimum retrigger time, t_{rr} is a function of internal propagation delays and the discharge time of C_X :

$$t_{rr}(\text{ns}) \approx 72 + \frac{V_{CC}(\text{volts}) \cdot C_X(\text{pF})}{30.5}$$

at room temperature

POWER-DOWN CONSIDERATIONS

Large values of C_X may cause problems when powering down the MM74HC4538 because of the amount of energy stored in the capacitor. When a system containing this

device is powered down, the capacitor may discharge from V_{CC} through the input protection diodes at pin 2 or pin 14. Current through the protection diodes must be limited to 30 mA; therefore, the turn-off time of the V_{CC} power supply must not be faster than $t = V_{CC} \cdot C_X / (30 \text{ mA})$. For example, if $V_{CC} = 5\text{V}$ and $C_X = 15 \mu\text{F}$, the V_{CC} supply must turn OFF no faster than $t = (15\text{V}) \cdot (15 \mu\text{F}) / 30 \text{ mA} = 2.5 \text{ ms}$. This is usually not a problem because power supplies are heavily filtered and cannot discharge at this rate.

When a more rapid decrease of V_{CC} to zero volts occurs, the MM74HC4538 may sustain damage. To avoid this possibility, use an external clamping diode, D_X , connected from V_{CC} to the C_X pin.

SET UP RECOMMENDATIONS

Minimum $R_X = 1 \text{ k}\Omega$

Minimum $C_X = 0 \text{ pF}$.

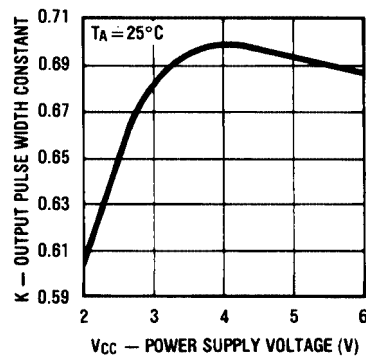

Absolute Maximum Ratings (Note 1)

(Note 2)

Supply Voltage (V_{CC})	-0.5 to +7.0V
DC Input Voltage (V_{IN})	-1.5 to $V_{CC} + 1.5V$
DC Output Voltage (V_{OUT})	-0.5 to $V_{CC} + 0.5V$
Clamp Diode Current (I_{IK}, I_{OK})	± 20 mA
DC Output Current, per pin (I_{OUT})	± 25 mA
DC V_{CC} or GND Current, per pin (I_{CC})	± 50 mA
Storage Temperature Range (T_{STG})	-65°C to +150°C
Power Dissipation (P_D)	
(Note 3)	600 mW
S.O. Package only	500 mW
Lead Temperature (T_L)	
(Soldering 10 seconds)	260°C

Recommended Operating Conditions

	Min	Max	Units
Supply Voltage (V_{CC})	2	6	V
DC Input or Output Voltage (V_{IN}, V_{OUT})	0	V_{CC}	V
Operating Temperature Range (T_A)	-40	+85	°C
Input Rise or Fall Times (Reset only)			
(t_r, t_f) $V_{CC} = 2.0V$		1000	ns
$V_{CC} = 4.5V$		500	ns
$V_{CC} = 6.0V$		400	ns

Note 1: Maximum Ratings are those values beyond which damage to the device may occur.

Note 2: Unless otherwise specified all voltages are referenced to ground.

Note 3: Power Dissipation Temperature Derating: Plastic "N" Package: -12mW/°C from 65°C to 85°C.

DC Electrical Characteristics (Note 4)

Symbol	Parameter	Conditions	V_{CC}	$T_A = 25^\circ C$		$T_A = -40$ to $85^\circ C$	$T_A = -55$ to $125^\circ C$	Units
				Typ	Guaranteed Limits			
V_{IH}	Minimum HIGH Level Input Voltage		2.0V		1.5	1.5	1.5	V
			4.5V		3.15	3.15	3.15	V
			6.0V		4.2	4.2	4.2	V
V_{IL}	Maximum LOW Level Input Voltage		2.0V		0.5	0.5	0.5	V
			4.5V		1.35	1.35	1.35	V
			6.0V		1.8	1.8	1.8	V
V_{OH}	Minimum HIGH Level Output Voltage	$V_{IN} = V_{IH}$ or V_{IL} $ I_{OUT} \leq 20 \mu A$	2.0V	2.0	1.9	1.9	1.9	V
			4.5V	4.5	4.4	4.4	4.4	V
			6.0V	6.0	5.9	5.9	5.9	V
		$V_{IN} = V_{IH}$ or V_{IL} $ I_{OUT} \leq 4.0$ mA $ I_{OUT} \leq 5.2$ mA	4.5V		3.98	3.84	3.7	V
			6.0V		5.48	5.34	5.2	V
V_{OL}	Maximum LOW Level Output Voltage	$V_{IN} = V_{IH}$ or V_{IL} $ I_{OUT} \leq 20 \mu A$	2.0V	0	0.1	0.1	0.1	V
			4.5V	0	0.1	0.1	0.1	V
			6.0V	0	0.1	0.1	0.1	V
		$V_{IN} = V_{IH}$ or V_{IL} $ I_{OUT} \leq 4.0$ mA $ I_{OUT} \leq 5.2$ mA	4.5V		0.26	0.33	0.4	V
			6.0V		0.26	0.33	0.4	V
I_{IN}	Maximum Input Current (Pins 2, 14) (Note 5)	$V_{IN} = V_{CC}$ or GND	6.0V		± 0.1	± 1.0	± 1.0	μA
I_{IN}	Maximum Input Current (all other pins)	$V_{IN} = V_{CC}$ or GND	6.0V		± 0.1	± 1.0	± 1.0	μA
I_{CC} Active	Maximum Active Supply Current	Pins 2, 14 = 0.5 V_{CC} Q1, Q2 = HIGH $V_{IN} = V_{CC}$ or GND	6.0V		150	250	400	μA
I_{CC} Quiescent	Maximum Quiescent Supply Current	Pins 2, 14 = OPEN Q1, Q2 = LOW $V_{IN} = V_{CC}$ or GND	6.0V		130	220	350	μA

Note 4: For a power supply of 5V $\pm 10\%$ the worst case output voltages (V_{OH} , and V_{OL}) occur for HC at 4.5V. Thus the 4.5V values should be used when designing with this supply. Worst case V_{IH} and V_{IL} occur at $V_{CC} = 5.5V$ and 4.5V respectively. (The V_{IH} value at 5.5V is 3.85V.) The worst case leakage current (I_{IN} , I_{CC} , and I_{OZ}) occur for CMOS at the higher voltage and so the 6.0V values should be used.

DC Electrical Characteristics (Continued)Note 5: The device must be set up with 3 steps before measuring I_{IN} :

	Clear	A	B
1.	H	L	H
2.	H	H	H
3.	H	L	H

AC Electrical Characteristics $V_{CC} = 5V$, $T_A = 25^\circ C$, $C_L = 15 pF$, $t_r = t_f = 6 ns$

Symbol	Parameter	Conditions	Typ	Limit	Units
t_{PLH}	Maximum Propagation Delay A, or B to Q		23	45	ns
t_{PHL}	Maximum Propagation Delay A, or B to \bar{Q}		26	50	ns
t_{PHL}	Maximum Propagation Delay Clear to Q		23	45	ns
t_{PLH}	Maximum Propagation Delay Clear to \bar{Q}		26	50	ns
t_W	Minimum Pulse Width A, B or Clear		10	16	ns

AC Electrical Characteristics $C_L = 50 pF$, $t_r = t_f = 6 ns$ (unless otherwise specified)

Symbol	Parameter	Conditions	V_{CC}	$T_A = 25^\circ C$			$T_A = -40 \text{ to } 85^\circ C$		$T_A = -55 \text{ to } 125^\circ C$		Units
				Typ	Guaranteed Limits						
t_{PLH}	Maximum Propagation Delay A, or B to Q		2.0V	100	250	315	373	ns			
			4.5V	25	50	63	75	ns			
			6.0V	21	43	54	63	ns			
t_{PHL}	Maximum Propagation Delay A, or B to \bar{Q}		2.0V	110	275	347	410	ns			
			4.5V	28	55	69	82	ns			
			6.0V	23	47	59	70	ns			
t_{PHL}	Maximum Propagation Delay Clear to Q		2.0V	100	250	315	373	ns			
			4.5V	25	50	63	75	ns			
			6.0V	21	43	54	63	ns			
t_{PLH}	Maximum Propagation Delay Clear to \bar{Q}		2.0V	110	275	347	410	ns			
			4.5V	28	55	69	82	ns			
			6.0V	23	47	59	70	ns			
t_{TLH}, t_{THL}	Maximum Output Rise and Fall Time		2.0V	30	75	95	110	ns			
			4.5V	10	15	19	22	ns			
			6.0V	8	13	16	19	ns			
t_r, t_f	Maximum Input Rise and Fall Time (Reset only)		2.0V		1000	1000	1000	ns			
			4.5V		500	500	500	ns			
			6.0V		400	400	400	ns			
t_W	Minimum Pulse Width A, B, Clear		2.0V		80	101	119	ns			
			4.5V		16	20	24	ns			
			6.0V		14	17	20	ns			
t_{REC}	Minimum Recovery Time, Clear Inactive to A or B		2.0V	-5	0	0	0	ns			
			4.5V		0	0	0	ns			
			6.0V		0	0	0	ns			
t_{WQ}	Output Pulse Width	$C_X = 12 pF$ $R_X = 1 k\Omega$	Min	3.0V	283	190			ns		
				5.0V	147	120			ns		
			Max	3.0V	283	400			ns		
				5.0V	147	185			ns		
t_{WQ}	Output Pulse Width	$C_X = 100 pF$ $R_X = 10 k\Omega$	Min	3.0V	1.2				μs		
				5.0V	1.0				μs		
			Max	3.0V	1.2				μs		
				5.0V	1.0				μs		

AC Electrical Characteristics (Continued)

Symbol	Parameter	Conditions	V _{CC}	T _A = -25°C		T _A = -40 to 85°C	T _A = -55 to 125°C	Units	
				Typ	Guaranteed Limits				
t _{WQ}	Output Pulse Width	C _X = 1000 pF R _X = 10 kΩ	Min	3.0V	10.5	9.4		μs	
				5.0V	10.0	9.3		μs	
			Max	3.0V	10.5	11.6		μs	
			5.0V	10.0	10.7		μs		
t _{WQ}	Output Pulse Width	C _X = 0.1μF R _X = 10k	Min	5.0V		0.63	0.602	0.595	ms
			Max	5.0V		0.77	0.798	0.805	ms
C _{IN}	Maximum Input Capacitance (Pins 2 & 14)			25				pF	
C _{IN}	Maximum Input Capacitance (other inputs)			5	10	10	10	pF	
C _{PD}	Power Dissipation Capacitance (Note 6)	(per one shot)		150				pF	
Δt _{WQ}	Pulse Width Match Between Circuits in Same Package			±1				%	

Note 6: C_{PD} determines the no load dynamic consumption, P_D = C_{PD} V_{CC}²f + I_{CC} V_{CC}, and the no load dynamic current consumption, I_S = V_{CC} f + I_{CC}.

Physical Dimensions inches (millimeters) unless otherwise noted

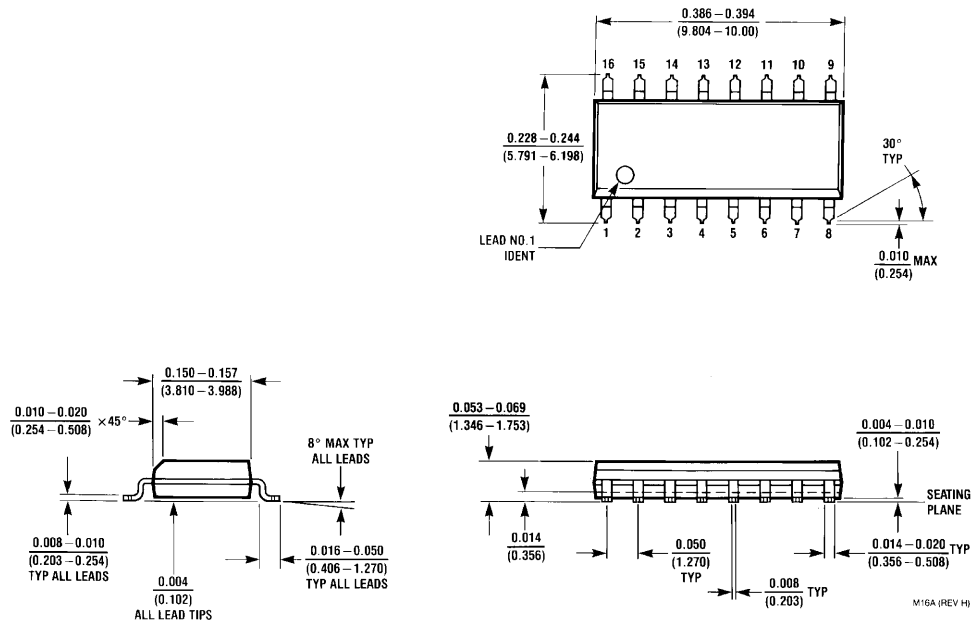

**16-Lead Small Outline Integrated Circuit (SOIC), JEDEC MS-012, 0.150 Narrow
Package Number M16A**

Physical Dimensions inches (millimeters) unless otherwise noted (Continued)

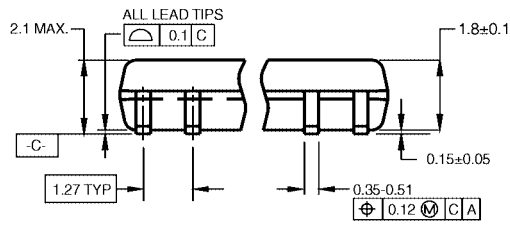
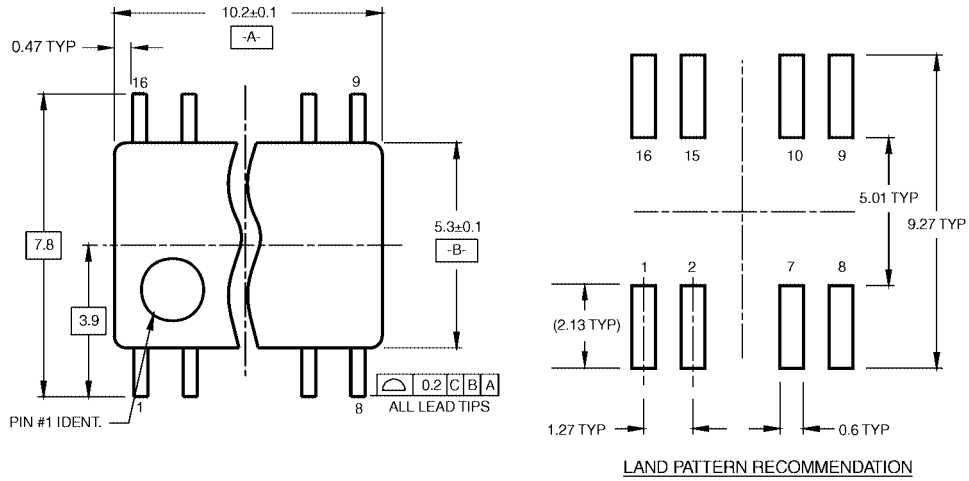

DIMENSIONS ARE IN MILLIMETERS

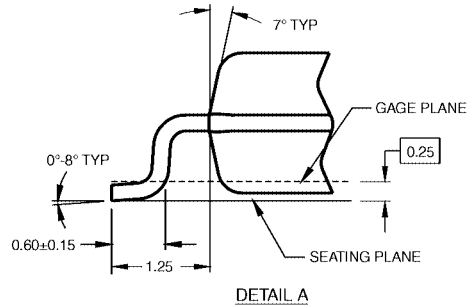
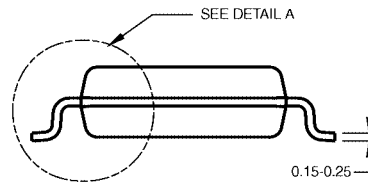

- NOTES:
 A. CONFORMS TO EIAJ EDR-7320 REGISTRATION, ESTABLISHED IN DECEMBER, 1998.
 B. DIMENSIONS ARE IN MILLIMETERS.
 C. DIMENSIONS ARE EXCLUSIVE OF BURRS, MOLD FLASH, AND TIE BAR EXTRUSIONS.

M16DRevB1

**16-Lead Small Outline Package (SOP), EIAJ TYPE II, 5.3mm Wide
 Package Number M16D**

Physical Dimensions inches (millimeters) unless otherwise noted (Continued)

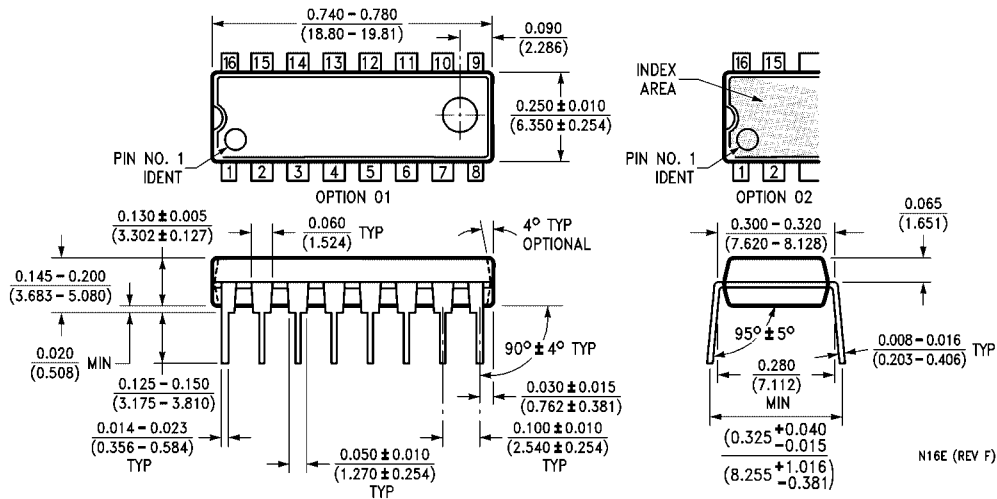

16-Lead Plastic Dual-In-Line Package (PDIP), JEDEC MS-001, 0.300 Wide Package Number N16E

Fairchild does not assume any responsibility for use of any circuitry described, no circuit patent licenses are implied and Fairchild reserves the right at any time without notice to change said circuitry and specifications.

LIFE SUPPORT POLICY

FAIRCHILD'S PRODUCTS ARE NOT AUTHORIZED FOR USE AS CRITICAL COMPONENTS IN LIFE SUPPORT DEVICES OR SYSTEMS WITHOUT THE EXPRESS WRITTEN APPROVAL OF THE PRESIDENT OF FAIRCHILD SEMICONDUCTOR CORPORATION. As used herein:

1. Life support devices or systems are devices or systems which, (a) are intended for surgical implant into the body, or (b) support or sustain life, and (c) whose failure to perform when properly used in accordance with instructions for use provided in the labeling, can be reasonably expected to result in a significant injury to the user.
2. A critical component in any component of a life support device or system whose failure to perform can be reasonably expected to cause the failure of the life support device or system, or to affect its safety or effectiveness.

www.fairchildsemi.com