

MPSA13

NPN Darlington Transistor

- This device is designed for applications requiring extremely high Current gain at collector Currents to 1.0A.
- Sourced from process 05.

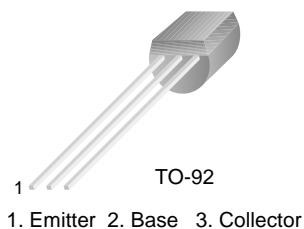

Absolute Maximum Ratings T_a = 25°C unless otherwise noted

Symbol	Parameter	Value	Units
V _{CES}	Collector-Emitter Voltage	30	V
V _{CBO}	Collector-Base Voltage	30	V
V _{EBO}	Emitter-Base Voltage	10	V
I _C	Collector Current - Continuous	1.2	A
T _J , T _{STG}	Operating and Storage Junction Temperature Range	-55 to +150	°C

Electrical Characteristics T_a = 25°C unless otherwise noted

Symbol	Parameter	Test Condition	Min.	Max.	Units
Off Characteristics					
V _{(BR)CES}	Collector-Emitter Breakdown Voltage	I _C = 100μA, I _B = 0	30		V
I _{CB0}	Collector-Cutoff Current	V _{CB} = 30V, I _E = 0		100	nA
I _{EBO}	Emitter-Cutoff Current	V _{EB} = 10V, I _C = 0		100	nA
On Characteristics *					
h _{FE}	DC Current Gain	V _{CE} = 5.0V, I _C = 10mA V _{CE} = 5.0, I _C = 100mA	5,000 10,000		
V _{CE(sat)}	Collector-Emitter Saturation Voltage	I _C = 100mA, I _B = 0.1mA		1.5	V
V _{BE(on)}	Base-Emitter On Voltage	I _C = 100mA, V _{CE} = 5.0V		2.0	V
Small Signal Characteristics					
f _T	Current Gain Bandwidth Product	I _C = 10mA, V _{CE} = 10V, f = 100MHz	125		pF

* Pulse Test: Pulse Width ≤ 300μs, Duty Cycle ≤ 2%

Thermal Characteristics $T_a=25^\circ\text{C}$ unless otherwise noted

Symbol	Parameter	Max.	Units
P_D	Total Device Dissipation Derate above 25°C	625 5.0	mW mW/ $^\circ\text{C}$
$R_{\theta JC}$	Thermal Resistance, Junction to Case	83.3	$^\circ\text{C}/\text{W}$
$R_{\theta JA}$	Thermal Resistance, Junction to Ambient	200	$^\circ\text{C}/\text{W}$

* Device mounted on FR-4PCB $1.6" \times 1.6" \times 0.06"$.

Typical Characteristics

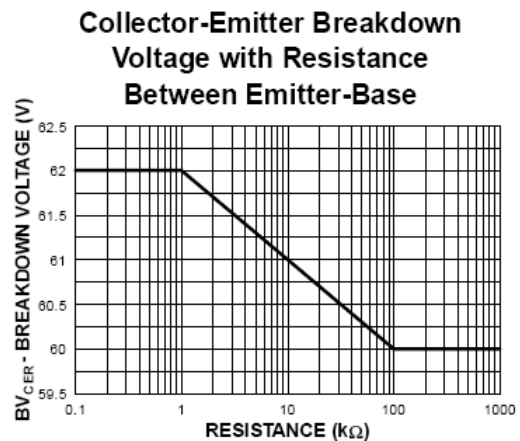
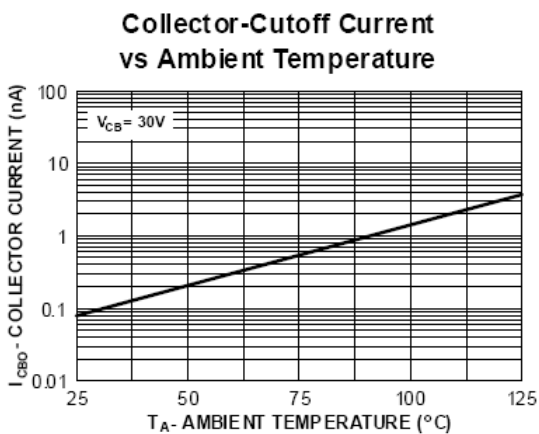
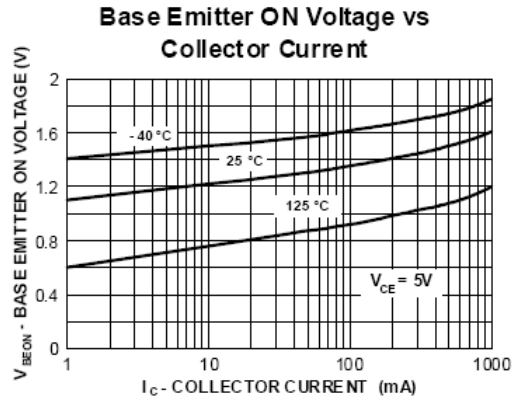
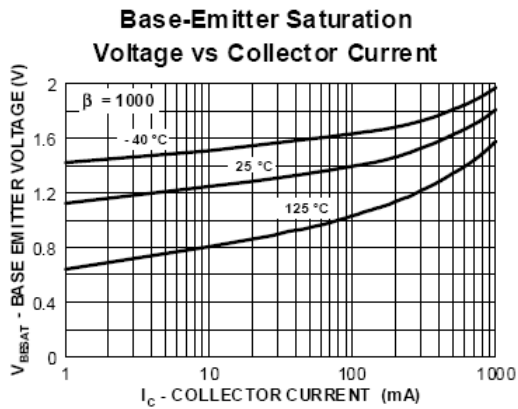
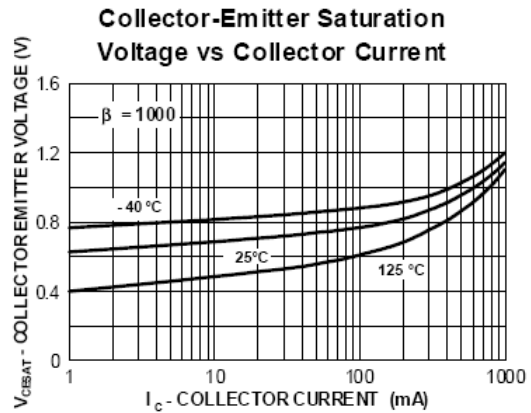
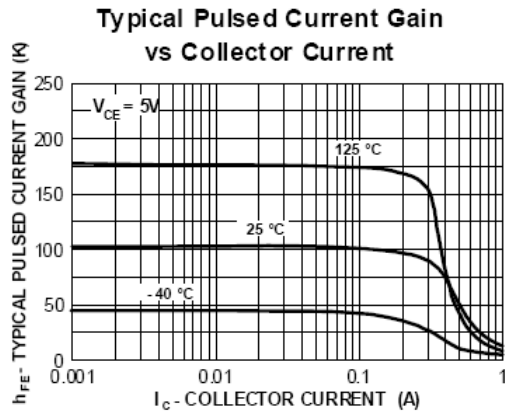

Typical Characteristics (continued)

Collector-Cutoff Current vs Ambient Temperature

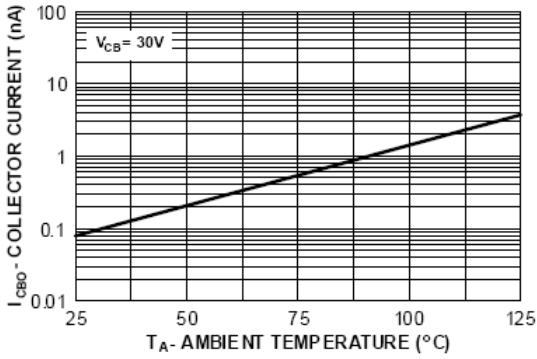

Collector-Emitter Breakdown Voltage with Resistance Between Emitter-Base

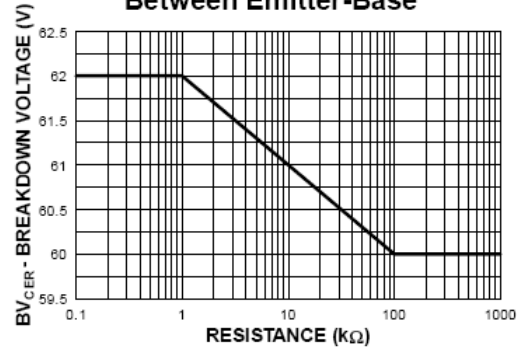

Input and Output Capacitance vs Reverse Voltage

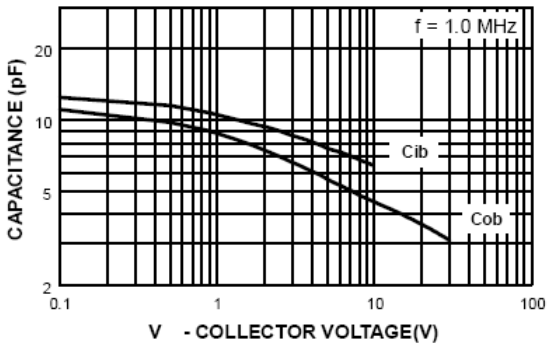

Gain Bandwidth Product vs Collector Current

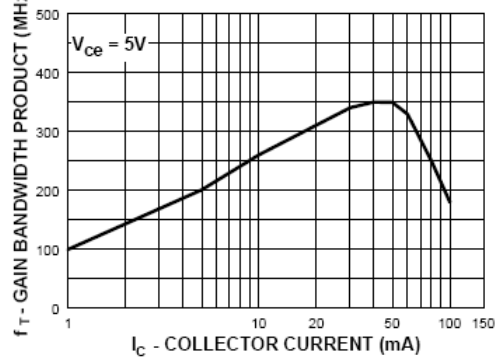

Mechanical Dimensions

TO-92

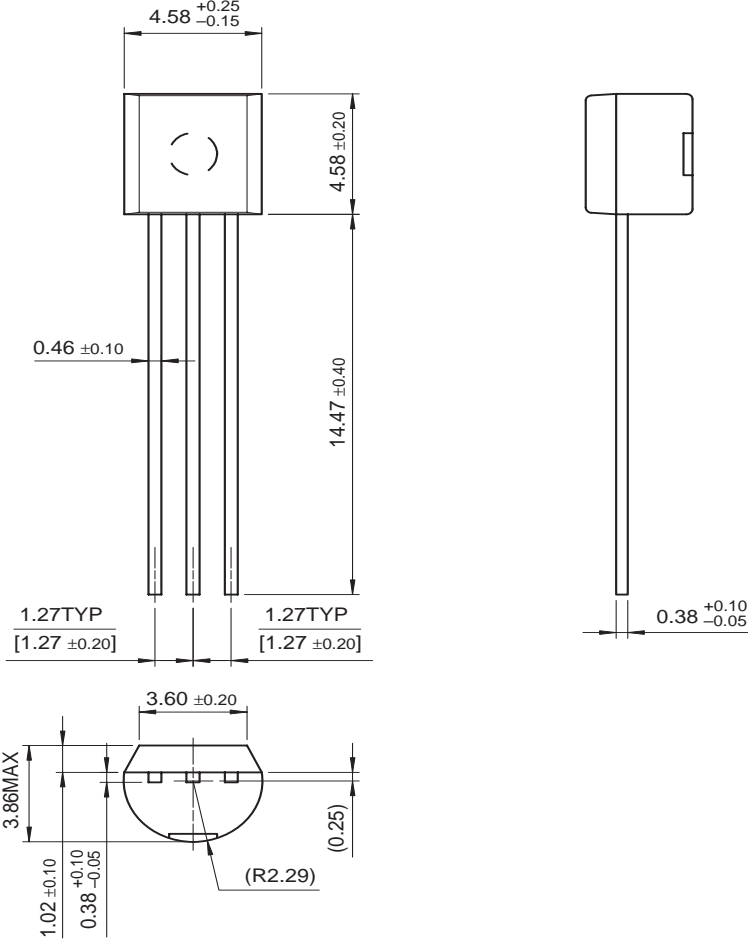

Dimensions in Millimeters



TRADEMARKS

The following are registered and unregistered trademarks Fairchild Semiconductor owns or is authorized to use and is not intended to be an exhaustive list of all such trademarks.

ACEx®	HiSeC™	PowerSaver™	TinyBoost™
Across the board. Around the world.™	<i>i-Lo</i> ™	PowerTrench®	TinyBuck™
ActiveArray™	ImpliedDisconnect™	Programmable Active Droop™	TinyLogic®
Bottomless™	IntelliMAX™	QFET®	TINYOPTO™
Build it Now™	ISOPLANAR™	QS™	TinyPower™
CoolFET™	MICROCOUPLER™	QT Optoelectronics™	TinyWire™
CROSSVOLT™	MicroPak™	Quiet Series™	TruTranslation™
CTL™	MICROWIRE™	RapidConfigure™	µSerDes™
Current Transfer Logic™	Motion-SPM™	RapidConnect™	UHC®
DOME™	MSX™	ScalarPump™	UniFET™
E ² CMOS™	MSXPro™	SMART START™	VCX™
EcoSPARK®	OCX™	SPM®	Wire™
EnSigna™	OCXPro™	STEALTH™	
FACT Quiet Series™	OPTOLOGIC®	SuperFET™	
FACT®	OPTOPLANAR®	SuperSOT™-3	
FAST®	PACMAN™	SuperSOT™-6	
FASTr™	PDP-SPM™	SuperSOT™-8	
FPS™	POP™	SyncFET™	
FRFET®	Power220®	TCM™	
GlobalOptoisolator™	Power247®	The Power Franchise®	
GTO™	PowerEdge™		

DISCLAIMER

FAIRCHILD SEMICONDUCTOR RESERVES THE RIGHT TO MAKE CHANGES WITHOUT FURTHER NOTICE TO ANY PRODUCTS HEREIN TO IMPROVE RELIABILITY, FUNCTION OR DESIGN. FAIRCHILD DOES NOT ASSUME ANY LIABILITY ARISING OUT OF THE APPLICATION OR USE OF ANY PRODUCT OR CIRCUIT DESCRIBED HEREIN; NEITHER DOES IT CONVEY ANY LICENSE UNDER ITS PATENT RIGHTS, NOR THE RIGHTS OF OTHERS. THESE SPECIFICATIONS DO NOT EXPAND THE TERMS OF FAIRCHILD'S WORLDWIDE TERMS AND CONDITIONS, SPECIFICALLY THE WARRANTY THEREIN, WHICH COVERS THESE PRODUCTS.

LIFE SUPPORT POLICY

FAIRCHILD'S PRODUCTS ARE NOT AUTHORIZED FOR USE AS CRITICAL COMPONENTS IN LIFE SUPPORT DEVICES OR SYSTEMS WITHOUT THE EXPRESS WRITTEN APPROVAL OF FAIRCHILD SEMICONDUCTOR CORPORATION.

As used herein:

1. Life support devices or systems are devices or systems which, (a) are intended for surgical implant into the body or (b) support or sustain life, and (c) whose failure to perform when properly used in accordance with instructions for use provided in the labeling, can be reasonably expected to result in a significant injury of the user.
2. A critical component in any component of a life support device, or system whose failure to perform can be reasonably expected to cause the failure of the life support device or system, or to affect its safety or effectiveness.

PRODUCT STATUS DEFINITIONS

Definition of Terms

Datasheet Identification	Product Status	Definition
Advance Information	Formative or In Design	This datasheet contains the design specifications for product development. Specifications may change in any manner without notice.
Preliminary	First Production	This datasheet contains preliminary data; supplementary data will be published at a later date. Fairchild Semiconductor reserves the right to make changes at any time without notice to improve design.
No Identification Needed	Full Production	This datasheet contains final specifications. Fairchild Semiconductor reserves the right to make changes at any time without notice to improve design.
Obsolete	Not In Production	This datasheet contains specifications on a product that has been discontinued by Fairchild Semiconductor. The datasheet is printed for reference information only.