



May 2015

S1A - S1M General-Purpose Rectifiers

Features

- 1 A $I_{F(AV)}$ Current Rating
- Glass Passivated
- Low Leakage:
 - 1 μ A Maximum at 25°C
 - 50 μ A Maximum at 125°C
- Fast Response: 1.8 μ s (Typical)
- 30 A Surge Rating
- 50 to 1000 V Reverse Voltage Ratings
- 6.6 pF Typical Capacitance
- RoHS Compliant
- UL Certified, UL #E258596

Description

In the world of commodity rectifiers, Fairchild Semiconductor's S1 family of 1 A, P-I-N, SMA rectifiers stand out for their optimized low leakage, low capacitance, and fast response time. This was achieved while maintaining the industry standard V_F max of 1.1 V at 1 A and a 30 A surge rating. In today's world, where system power efficiency is a critical differentiating feature, these advantages can be leveraged to support those higher efficiency goals.

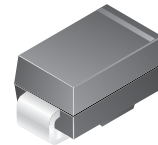

SMA/DO-214AC
COLOR BAND DENOTES CATHODE

Ordering Information

Part Number	Marking	Package	Packing Method
S1A	S1A	DO-214AC (SMA)	Tape and Reel
S1B	S1B	DO-214AC (SMA)	Tape and Reel
S1D	S1D	DO-214AC (SMA)	Tape and Reel
S1G	S1G	DO-214AC (SMA)	Tape and Reel
S1J	S1J	DO-214AC (SMA)	Tape and Reel
S1K	S1K	DO-214AC (SMA)	Tape and Reel
S1M	S1M	DO-214AC (SMA)	Tape and Reel

Absolute Maximum Ratings⁽¹⁾

Stresses exceeding the absolute maximum ratings may damage the device. The device may not function or be operable above the recommended operating conditions and stressing the parts to these levels is not recommended. In addition, extended exposure to stresses above the recommended operating conditions may affect device reliability. The absolute maximum ratings are stress ratings only. Values are at $T_A = 25^\circ\text{C}$ unless otherwise noted.

Symbol	Parameter	Value							Unit
		S1A	S1B	S1D	S1G	S1J	S1K	S1M	
V_{RRM}	Maximum Repetitive Reverse Voltage	50	100	200	400	600	800	1000	V
$I_{F(AV)}$	Average Rectified Forward Current at $T_A = 100^\circ\text{C}$	1.0							A
I_{FSM}	Non-Repetitive Peak Forward Surge Current 8.3 ms Single Half-Sine-Wave	30							A
T_{STG}	Storage Temperature Range	-55 to +150							$^\circ\text{C}$
T_J	Operating Junction Temperature	-55 to +150							$^\circ\text{C}$

Note:

1. These ratings are limiting values above which the serviceability of any semiconductor device maybe impaired.

Thermal Characteristics

Symbol	Parameter	Max.	Unit
P_D	Power Dissipation	1.4	W
$R_{\theta JA}$	Thermal Resistance, Junction to Ambient ⁽²⁾	85	$^\circ\text{C}/\text{W}$
$R_{\theta JA}$	Thermal Resistance, Junction to Ambient ⁽³⁾	170	$^\circ\text{C}/\text{W}$
Ψ_{jl}	Junction-Lead thermal characteristics ⁽³⁾	25	$^\circ\text{C}/\text{W}$

Notes:

2. Device mounted on FR-4 PCB, land pattern size: 25 mm² (5 x 5 mm).
3. Device mounted on FR-4 PCB, land pattern size: 4.6375 mm² (2.65 x 1.75 mm).

Electrical Characteristics

Values are at $T_A = 25^\circ\text{C}$ unless otherwise noted.

Symbol	Parameter	Conditions	Min.	Typ.	Max.	Unit
V_F	Forward Voltage	$I_F = 1.0 \text{ A}$			1.1	V
t_{rr}	Reverse Recovery Time	$I_F = 0.5 \text{ A}$, $I_R = 1.0 \text{ A}$, $I_{rr} = 0.25 \text{ A}$		1.8		μs
I_R	Reverse Current at Rated V_R	$T_A = 25^\circ\text{C}$			1.0	μA
		$T_A = 125^\circ\text{C}$			50	
C_T	Junction Capacitance	$V_R = 4.0 \text{ V}$, $f = 1.0\text{MHz}$		6.6		pF

Typical Performance Characteristics

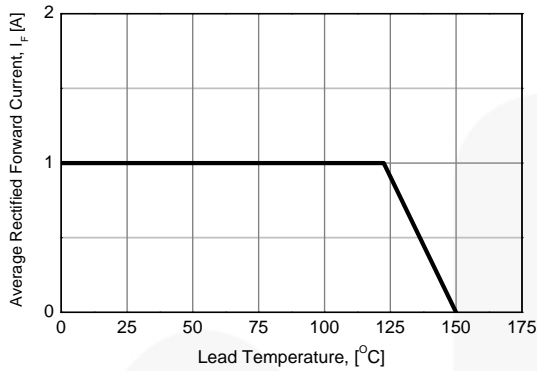

Figure 1. Forward Current Derating Curve

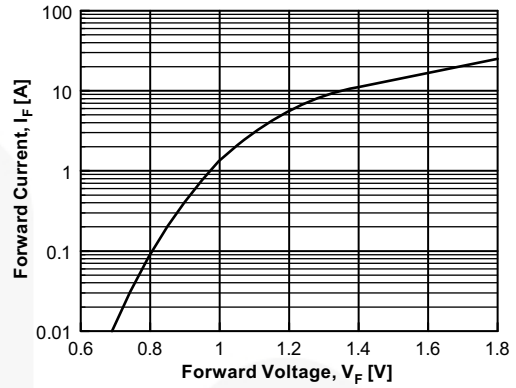

Figure 2. Forward Voltage Characteristics

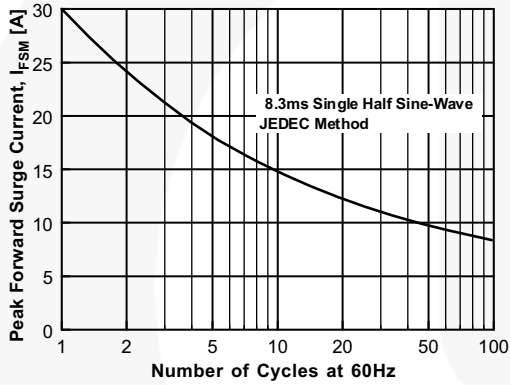

Figure 3. Non-Repetitive Surge Current

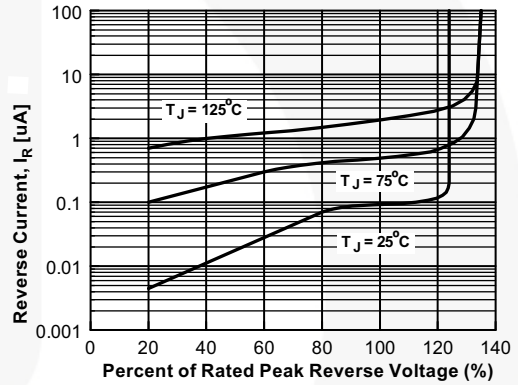

Figure 4. Reverse Current vs. Reverse Voltage

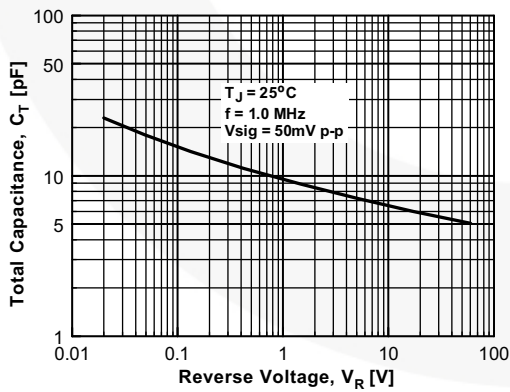

Figure 5. Total Capacitance

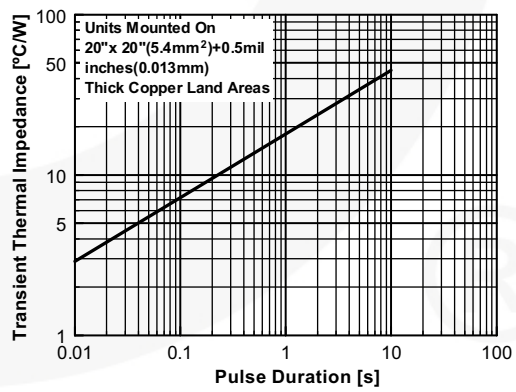
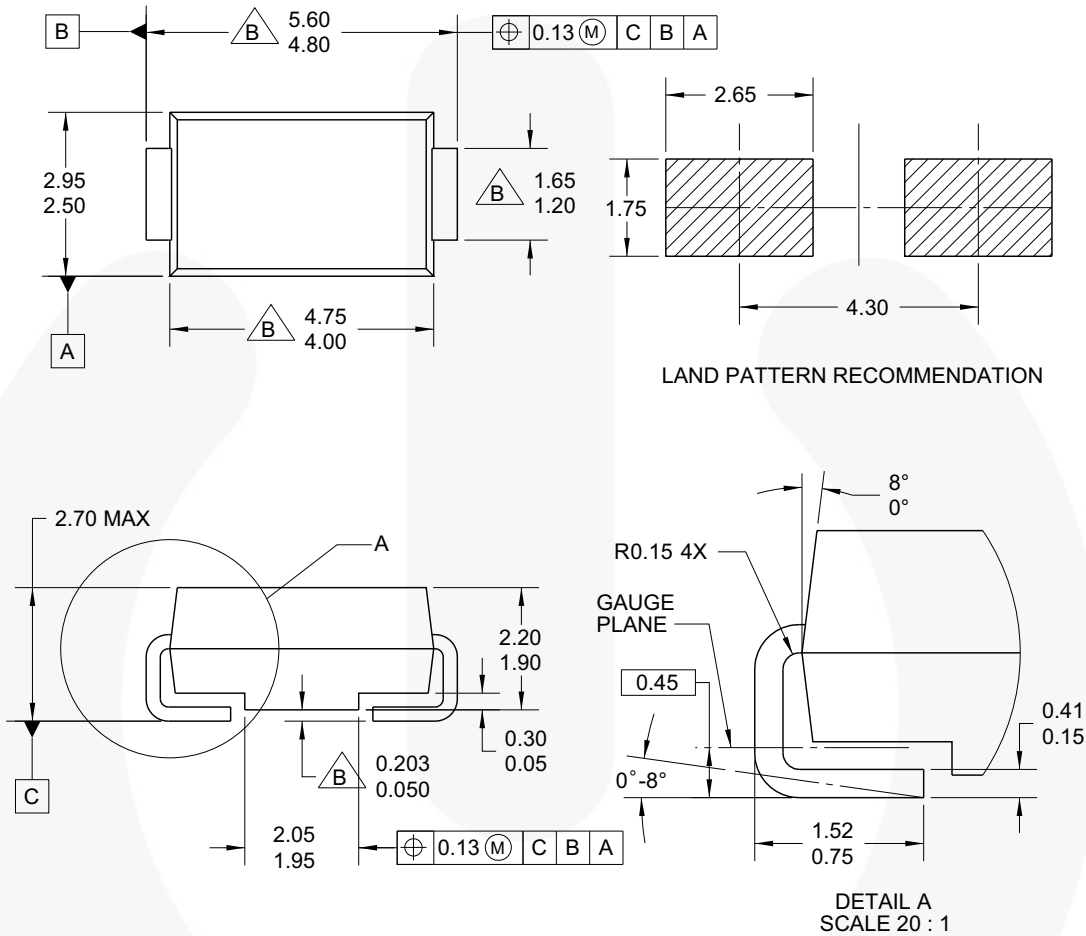

Figure 6. Thermal Impedance Characteristics

Physical Dimensions



NOTES:

- A. EXCEPT WHERE NOTED CONFORMS TO JEDEC DO214 VARIATION AC.
- B. DOES NOT COMPLY JEDEC STD. VALUE.
- C. ALL DIMENSIONS ARE IN MILLIMETERS.
- D. DIMENSIONS ARE EXCLUSIVE OF BURRS, MOLD FLASH AND TIE BAR PROTRUSIONS.
- E. DIMENSION AND TOLERANCE AS PER ASME Y14.5-1994.
- F. LAND PATTERN STD. DIOM5025X231M.
- G. DRAWING FILE NAME: DO214ACREV1

Figure 7. 2-LEAD, SMA, JEDEC DO-214, VARIATION AC





TRADEMARKS

The following includes registered and unregistered trademarks and service marks, owned by Fairchild Semiconductor and/or its global subsidiaries, and is not intended to be an exhaustive list of all such trademarks.

AccuPower™
 AttitudeEngine™
 Awinda®
 AX-CAP®
 BitSiC™
 Build it Now™
 CorePLUS™
 CorePOWER™
 CROSSVOLT™
 CTL™
 Current Transfer Logic™
 DEUXPEED®
 Dual Cool™
 EcoSPARK®
 EfficientMax™
 ESBC™

 Fairchild®
 Fairchild Semiconductor®
 FACT Quiet Series™
 FACT®
 FAST®
 FastvCore™
 FETBench™
 FPS™

F-PFS™
 FRFET®
 Global Power ResourceSM
 GreenBridge™
 Green FPS™
 Green FPS™ e-Series™
 Gmax™
 GTO™
 IntelliMAX™
 ISOPLANAR™
 Making Small Speakers Sound Louder and Better™
 MegaBuck™
 MICROCOUPLER™
 MicroFET™
 MicroPak™
 MicroPak2™
 MillerDrive™
 MotionMax™
 MotionGrid®
 MT[®]
 MTx[®]
 MVN[®]
 mWSaver®
 OptoHiT™
 OPTOLOGIC®

OPTOPLANAR®

 Power Supply WebDesigner™
 PowerTrench®
 PowerXS™
 Programmable Active Droop™
 QFET®
 QS™
 Quiet Series™
 RapidConfigure™

 Saving our world, 1mW/W/kW at a time™
 SignalWise™
 SmartMax™
 SMART START™
 Solutions for Your Success™
 SPM®
 STEALTH™
 SuperFET®
 SuperSOT™-3
 SuperSOT™-6
 SuperSOT™-8
 SupreMOS®
 SyncFET™
 Sync-Lock™

 SYSTEM GENERAL®
 TinyBoost®
 TinyBuck®
 TinyCalc™
 TinyLogic®
 TINYOPTO™
 TinyPower™
 TinyPWM™
 TinyWire™
 TranSiC™
 TriFault Detect™
 TRUECURRENT®
 μSerDes™

 UHC®
 Ultra FRFET™
 UniFET™
 VCX™
 VisualMax™
 VoltagePlus™
 XS™
 Xsens™
 仙童™

* Trademarks of System General Corporation, used under license by Fairchild Semiconductor.

DISCLAIMER

FAIRCHILD SEMICONDUCTOR RESERVES THE RIGHT TO MAKE CHANGES WITHOUT FURTHER NOTICE TO ANY PRODUCTS HEREIN TO IMPROVE RELIABILITY, FUNCTION, OR DESIGN. TO OBTAIN THE LATEST, MOST UP-TO-DATE DATASHEET AND PRODUCT INFORMATION, VISIT OUR WEBSITE AT <http://www.fairchildsemi.com>. FAIRCHILD DOES NOT ASSUME ANY LIABILITY ARISING OUT OF THE APPLICATION OR USE OF ANY PRODUCT OR CIRCUIT DESCRIBED HEREIN; NEITHER DOES IT CONVEY ANY LICENSE UNDER ITS PATENT RIGHTS, NOR THE RIGHTS OF OTHERS. THESE SPECIFICATIONS DO NOT EXPAND THE TERMS OF FAIRCHILD'S WORLDWIDE TERMS AND CONDITIONS, SPECIFICALLY THE WARRANTY THEREIN, WHICH COVERS THESE PRODUCTS.

LIFE SUPPORT POLICY

FAIRCHILD'S PRODUCTS ARE NOT AUTHORIZED FOR USE AS CRITICAL COMPONENTS IN LIFE SUPPORT DEVICES OR SYSTEMS WITHOUT THE EXPRESS WRITTEN APPROVAL OF FAIRCHILD SEMICONDUCTOR CORPORATION.

As used herein:

1. Life support devices or systems are devices or systems which, (a) are intended for surgical implant into the body or (b) support or sustain life, and (c) whose failure to perform when properly used in accordance with instructions for use provided in the labeling, can be reasonably expected to result in a significant injury of the user.
2. A critical component in any component of a life support, device, or system whose failure to perform can be reasonably expected to cause the failure of the life support device or system, or to affect its safety or effectiveness.

ANTI-COUNTERFEITING POLICY

Fairchild Semiconductor Corporation's Anti-Counterfeiting Policy. Fairchild's Anti-Counterfeiting Policy is also stated on our external website, www.fairchildsemi.com, under Sales Support.

Counterfeiting of semiconductor parts is a growing problem in the industry. All manufacturers of semiconductor products are experiencing counterfeit parts. Customers who inadvertently purchase counterfeit parts experience many problems such as loss of brand reputation, substandard performance, failed applications, and increased cost of production and manufacturing delays. Fairchild is taking strong measures to protect ourselves and our customers from the proliferation of counterfeit parts. Fairchild strongly encourages customers to purchase Fairchild parts either directly from Fairchild or from Authorized Fairchild Distributors who are listed by country on our web page cited above. Products customers buy either from Fairchild directly or from Authorized Fairchild Distributors are genuine parts, have full traceability, meet Fairchild's quality standards for handling and storage and provide access to Fairchild's full range of up-to-date technical and product information. Fairchild and our Authorized Distributors will stand behind all warranties and will appropriately address any warranty issues that may arise. Fairchild will not provide any warranty coverage or other assistance for parts bought from Unauthorized Sources. Fairchild is committed to combat this global problem and encourage our customers to do their part in stopping this practice by buying direct or from authorized distributors.

PRODUCT STATUS DEFINITIONS

Definition of Terms

Datasheet Identification	Product Status	Definition
Advance Information	Formative / In Design	Datasheet contains the design specifications for product development. Specifications may change in any manner without notice.
Preliminary	First Production	Datasheet contains preliminary data; supplementary data will be published at a later date. Fairchild Semiconductor reserves the right to make changes at any time without notice to improve design.
No Identification Needed	Full Production	Datasheet contains final specifications. Fairchild Semiconductor reserves the right to make changes at any time without notice to improve the design.
Obsolete	Not In Production	Datasheet contains specifications on a product that is discontinued by Fairchild Semiconductor. The datasheet is for reference information only.

Rev. 174