



January 2016

# BC556 / BC557 / BC558 / BC559 / BC560 PNP Epitaxial Silicon Transistor

## Features

- Switching and Amplifier
- High-Voltage: BC556,  $V_{CEO} = -65\text{ V}$
- Low-Noise: BC559, BC560
- Complement to BC546, BC547, BC548, BC549, and BC550

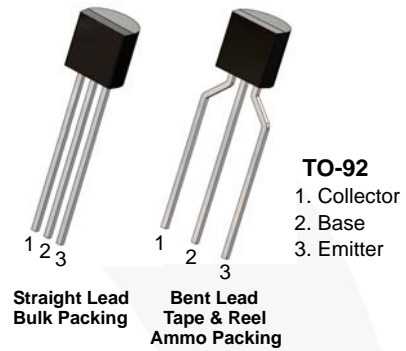

## Ordering Information

| Part Number | Marking | Package  | Packing Method |
|-------------|---------|----------|----------------|
| BC556ABU    | BC556A  | TO-92 3L | Bulk           |
| BC556ATA    | BC556A  | TO-92 3L | Ammo           |
| BC556BTA    | BC556B  | TO-92 3L | Ammo           |
| BC556BTF    | BC556B  | TO-92 3L | Tape and Reel  |
| BC556BTFR   | BC556B  | TO-92 3L | Tape and Reel  |
| BC557ATA    | BC557A  | TO-92 3L | Ammo           |
| BC557BTA    | BC557B  | TO-92 3L | Ammo           |
| BC557BTF    | BC557B  | TO-92 3L | Tape and Reel  |
| BC558BTA    | BC558B  | TO-92 3L | Ammo           |
| BC559BTA    | BC559B  | TO-92 3L | Ammo           |
| BC559CTA    | BC559C  | TO-92 3L | Ammo           |
| BC560CTA    | BC560C  | TO-92 3L | Ammo           |

BC556 / BC557 / BC558 / BC559 / BC560 — PNP Epitaxial Silicon Transistor

## Absolute Maximum Ratings

Stresses exceeding the absolute maximum ratings may damage the device. The device may not function or be operable above the recommended operating conditions and stressing the parts to these levels is not recommended. In addition, extended exposure to stresses above the recommended operating conditions may affect device reliability. The absolute maximum ratings are stress ratings only. Values are at  $T_A = 25^\circ\text{C}$  unless otherwise noted.

| Symbol    | Parameter                      | Value         | Unit             |   |
|-----------|--------------------------------|---------------|------------------|---|
| $V_{CBO}$ | Collector-Base Voltage         | BC556         | -80              | V |
|           |                                | BC557 / BC560 | -50              |   |
|           |                                | BC558 / BC559 | -30              |   |
| $V_{CEO}$ | Collector-Emitter Voltage      | BC556         | -65              | V |
|           |                                | BC557 / BC560 | -45              |   |
|           |                                | BC558 / BC559 | -30              |   |
| $V_{EBO}$ | Emitter-Base Voltage           | -5            | V                |   |
| $I_C$     | Collector Current (DC)         | -100          | mA               |   |
| $I_{CP}$  | Peak Collector Current (Pulse) | -200          | mA               |   |
| $I_{BP}$  | Peak Base Current (Pulse)      | -200          | mA               |   |
| $T_J$     | Junction Temperature           | 150           | $^\circ\text{C}$ |   |
| $T_{STG}$ | Storage Temperature Range      | -65 to +150   | $^\circ\text{C}$ |   |

## Thermal Characteristics<sup>(1)</sup>

Values are at  $T_A = 25^\circ\text{C}$  unless otherwise noted.

| Symbol          | Parameter                               | Max. | Unit                      |
|-----------------|---|------|---------------------------|
| $P_D$           | Total Power Dissipation                 | 500  | mW                        |
|                 | Derate Above $25^\circ\text{C}$         | 4.0  | mW/ $^\circ\text{C}$      |
| $R_{\theta JA}$ | Thermal Resistance, Junction-to-Ambient | 250  | $^\circ\text{C}/\text{W}$ |

### Note:

1. PCB size: FR-4, 76 mm x 114 mm x 1.57 mm (3.0 inch x 4.5 inch x 0.062 inch) with minimum land pattern size.

## Electrical Characteristics

Values are at  $T_A = 25^\circ\text{C}$  unless otherwise noted.

| Symbol        | Parameter                            | Conditions   | Min.   | Typ. | Max. | Unit |
|---------------|--------------------------------------|--|--|------|------|------|
| $I_{CBO}$     | Collector Cut-Off Current            | $V_{CB} = -30\text{ V}, I_E = 0$                               |  |      | -15  | nA   |
| $h_{FE}$      | DC Current Gain                      | $V_{CE} = -5\text{ V}, I_C = -2\text{ mA}$                     | 110  |      | 800  |      |
| $V_{CE(sat)}$ | Collector-Emitter Saturation Voltage | $I_C = -10\text{ mA}, I_B = -0.5\text{ mA}$                    |  | -90  | -300 | mV   |
|               |                                      | $I_C = -100\text{ mA}, I_B = -5\text{ mA}$                     |  | -250 | -650 |      |
| $V_{BE(sat)}$ | Collector-Base Saturation Voltage    | $I_C = -10\text{ mA}, I_B = -0.5\text{ mA}$                    |  | -700 |      | mV   |
|               |                                      | $I_C = -100\text{ mA}, I_B = -5\text{ mA}$                     |  | -900 |      |      |
| $V_{BE(on)}$  | Base-Emitter On Voltage              | $V_{CE} = -5\text{ V}, I_C = -2\text{ mA}$                     | -600   | -660 | -750 | mV   |
|               |                                      | $V_{CE} = -5\text{ V}, I_C = -10\text{ mA}$                    |  |      | -800 |      |
| $f_T$         | Current Gain Bandwidth Product       | $V_{CE} = -5\text{ V}, I_C = -10\text{ mA}, f = 10\text{ MHz}$ |  | 150  |      | MHz  |
| $C_{ob}$      | Output Capacitance                   | $V_{CB} = -10\text{ V}, I_E = 0, f = 1\text{ MHz}$             |  |      | 6    | pF   |
| NF            | Noise Figure                         | BC556 / BC557 / BC558  | $V_{CE} = -5\text{ V}, I_C = -200\text{ }\mu\text{A}, f = 1\text{ kHz}, R_G = 2\text{ k}\Omega$                  | 2    | 10   | dB   |
|               |                                      | BC559 / BC560  |  | 1    | 4    |      |
|               |                                      | BC559  | $V_{CE} = -5\text{ V}, I_C = -200\text{ }\mu\text{A}, R_G = 2\text{ k}\Omega, f = 30\text{ to }15000\text{ MHz}$ | 1.2  | 4.0  |      |
|               |                                      | BC560  |  | 1.2  | 2.0  |      |

## $h_{FE}$ Classification

| Classification | A         | B         | C         |
|----------------|-----------|-----------|-----------|
| $h_{FE}$       | 110 ~ 220 | 200 ~ 450 | 420 ~ 800 |

## Typical Performance Characteristics

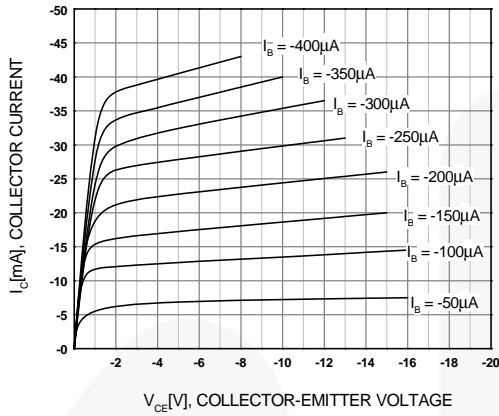

Figure 1. Static Characteristic

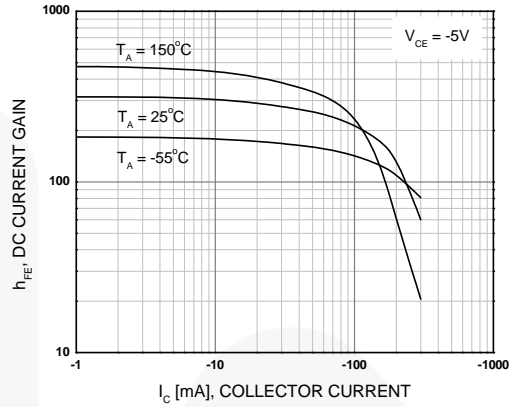

Figure 2. DC Current Gain

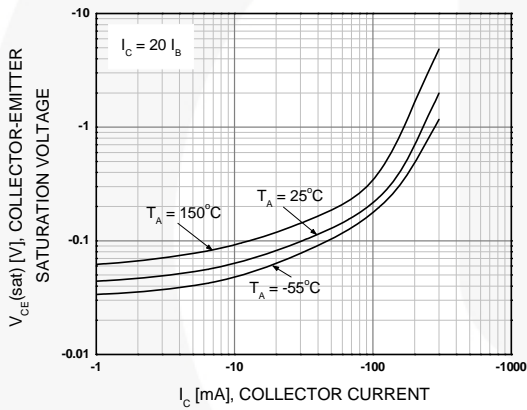

Figure 3. Collector-Emitter Saturation Voltage

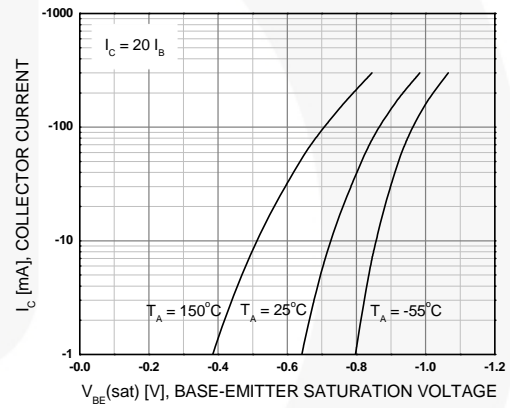

Figure 4. Base-Emitter Saturation Voltage

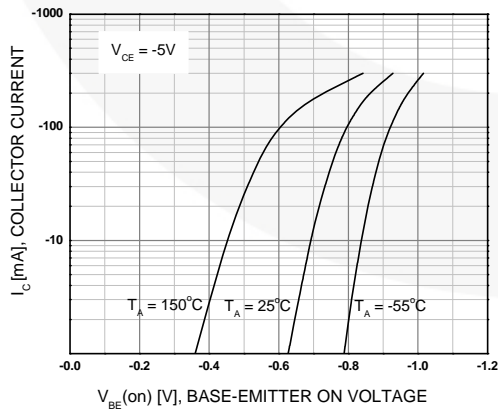

Figure 5. Base-Emitter On Voltage

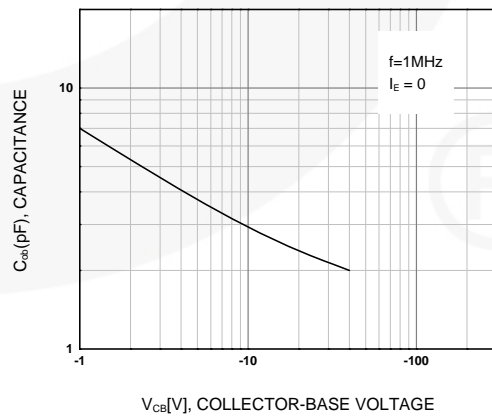

Figure 6. Collector Output Capacitance

Typical Performance Characteristics (Continued)

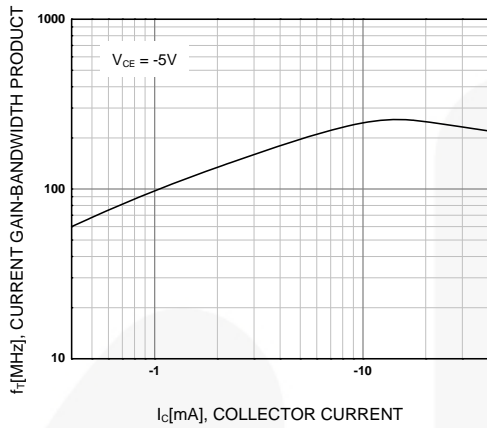

Figure 7. Current Gain Bandwidth Product

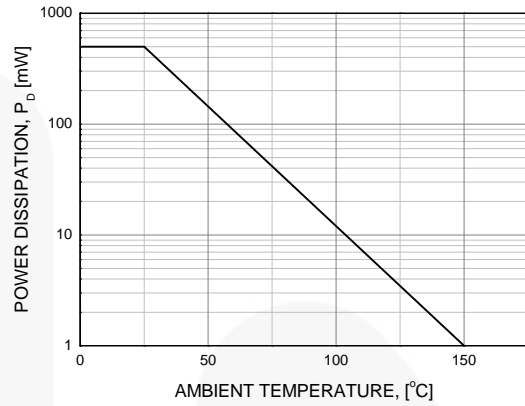

Figure 8. Power Deration

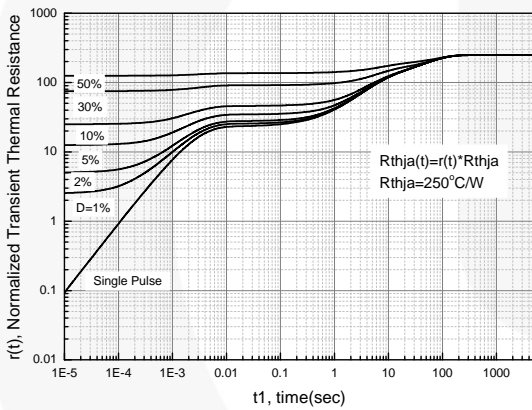
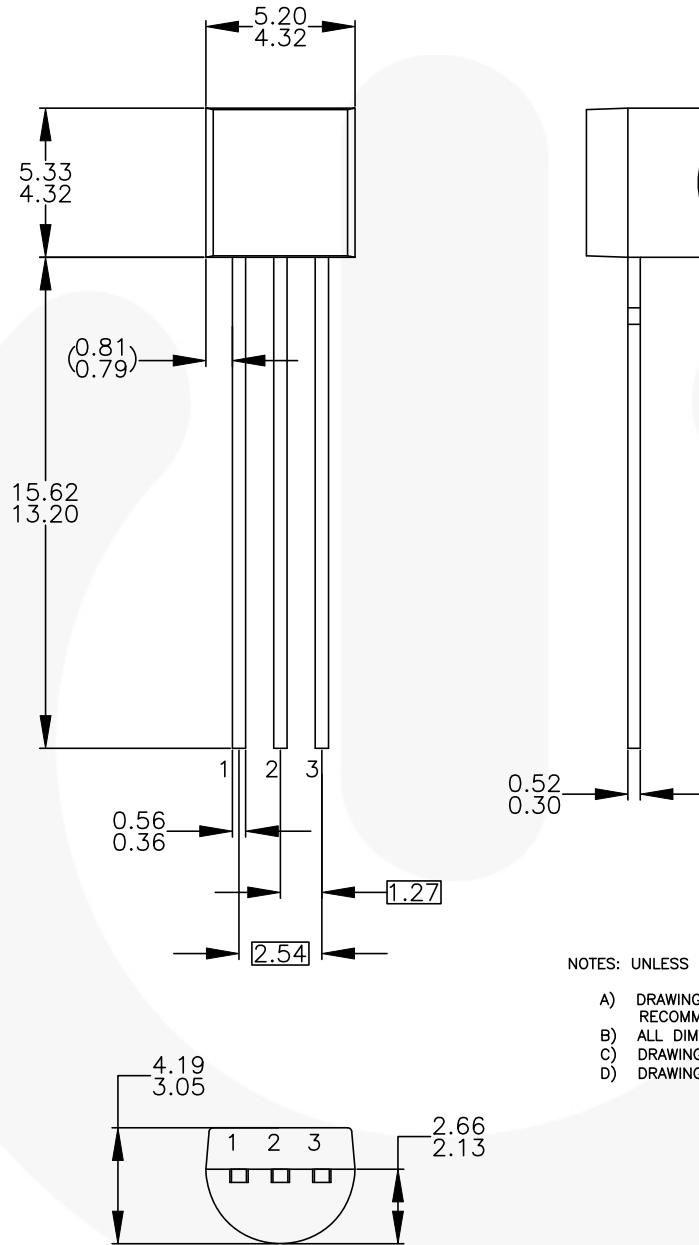

Figure 9. Normalized Transient Thermal Resistance

Physical Dimensions



NOTES: UNLESS OTHERWISE SPECIFIED

- A) DRAWING WITH REFERENCE TO JEDEC TO-92 RECOMMENDATIONS.
- B) ALL DIMENSIONS ARE IN MILLIMETERS.
- C) DRAWING CONFORMS TO ASME Y14.5M-2009.
- D) DRAWING FILENAME: MKT-ZA03DREV4.



Figure 10. 3-LEAD, TO92, JEDEC TO-92 COMPLIANT STRAIGHT LEAD CONFIGURATION, BULK

Physical Dimensions (Continued)

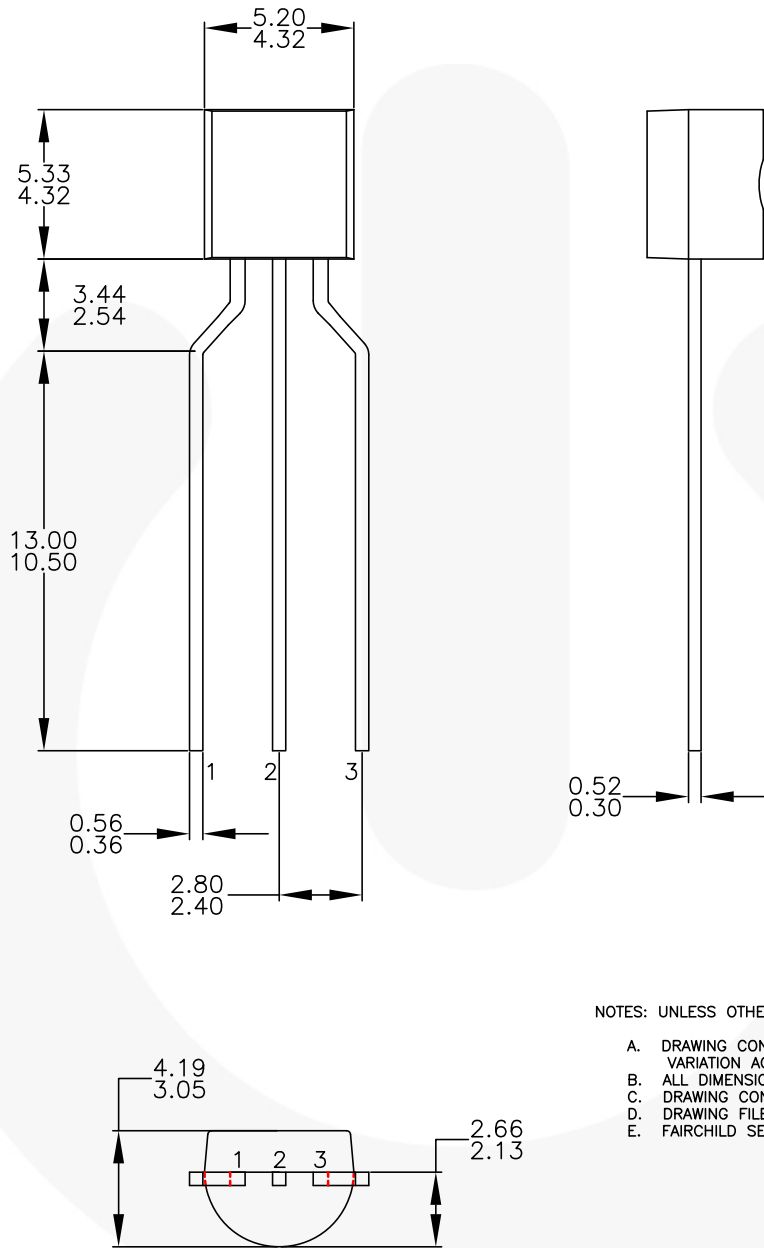

NOTES: UNLESS OTHERWISE SPECIFIED

- A. DRAWING CONFORMS TO JEDEC MS-013, VARIATION AC.
- B. ALL DIMENSIONS ARE IN MILLIMETERS.
- C. DRAWING CONFORMS TO ASME Y14.5M-2009.
- D. DRAWING FILENAME: MKT-ZA03FREV3.
- E. FAIRCHILD SEMICONDUCTOR.

Figure 11. 3-LEAD, TO92, MOLDED 0.200 IN LINE SPACING LEAD FORM, AMMO, TAPE AND REEL





**TRADEMARKS**

The following includes registered and unregistered trademarks and service marks, owned by Fairchild Semiconductor and/or its global subsidiaries, and is not intended to be an exhaustive list of all such trademarks.

AccuPower™  
 AttitudeEngine™  
 Awinda®  
 AX-CAP®  
 BitSiC™  
 Build it Now™  
 CorePLUS™  
 CorePOWER™  
 CROSSVOLT™  
 CTL™  
 Current Transfer Logic™  
 DEUXPEED®  
 Dual Cool™  
 EcoSPARK®  
 EfficientMax™  
 ESBC™  
 F®  
 Fairchild®  
 Fairchild Semiconductor®  
 FACT Quiet Series™  
 FACT®  
 FastvCore™  
 FASTBench™  
 FPS™

F-PFS™  
 FRFET®  
 Global Power Resource™  
 GreenBridge™  
 Green FPS™  
 Green FPS™ e-Series™  
 Gmax™  
 GTO™  
 IntelliMAX™  
 ISOPLANAR™  
 Making Small Speakers Sound Louder and Better™  
 MegaBuck™  
 MICROCOUPLER™  
 MicroFET™  
 MicroPak™  
 MicroPak2™  
 MillerDrive™  
 MotionMax™  
 MotionGrid®  
 MTi®  
 MTx®  
 MVN®  
 mWSaver®  
 OptoHiT™  
 OPTOLOGIC®

OPTOPLANAR®  
  
 Power Supply WebDesigner™  
 PowerTrench®  
 PowerXS™  
 Programmable Active Droop™  
 QFET®  
 QS™  
 Quiet Series™  
 RapidConfigure™  
  
 Saving our world, 1mW/W/kW at a time™  
 SignalWise™  
 SmartMax™  
 SMART START™  
 Solutions for Your Success™  
 SPM®  
 STEALTH™  
 SuperFET®  
 SuperSOT™-3  
 SuperSOT™-6  
 SuperSOT™-8  
 SupreMOS®  
 SyncFET™  
 Sync-Lock™

 SYSTEM GENERAL®  
 TinyBoost®  
 TinyBuck®  
 TinyCalc™  
 TinyLogic®  
 TINYOPTO™  
 TinyPower™  
 TinyPWM™  
 TinyWire™  
 TranSiC™  
 TriFault Detect™  
 TRUECURRENT®  
 μSerDes™  
 SerDes®  
 UHC®  
 Ultra FRFET™  
 UniFET™  
 VCX™  
 VisualMax™  
 VoltagePlus™  
 XS™  
 Xsens™  
 仙童®

\* Trademarks of System General Corporation, used under license by Fairchild Semiconductor.

**DISCLAIMER**

FAIRCHILD SEMICONDUCTOR RESERVES THE RIGHT TO MAKE CHANGES WITHOUT FURTHER NOTICE TO ANY PRODUCTS HEREIN TO IMPROVE RELIABILITY, FUNCTION, OR DESIGN. TO OBTAIN THE LATEST, MOST UP-TO-DATE DATASHEET AND PRODUCT INFORMATION, VISIT OUR WEBSITE AT [HTTP://WWW.FAIRCHILDSEMI.COM](http://www.fairchildsemi.com). FAIRCHILD DOES NOT ASSUME ANY LIABILITY ARISING OUT OF THE APPLICATION OR USE OF ANY PRODUCT OR CIRCUIT DESCRIBED HEREIN; NEITHER DOES IT CONVEY ANY LICENSE UNDER ITS PATENT RIGHTS, NOR THE RIGHTS OF OTHERS. THESE SPECIFICATIONS DO NOT EXPAND THE TERMS OF FAIRCHILD'S WORLDWIDE TERMS AND CONDITIONS, SPECIFICALLY THE WARRANTY THEREIN, WHICH COVERS THESE PRODUCTS.

**AUTHORIZED USE**

Unless otherwise specified in this data sheet, this product is a standard commercial product and is not intended for use in applications that require extraordinary levels of quality and reliability. This product may not be used in the following applications, unless specifically approved in writing by a Fairchild officer: (1) automotive or other transportation, (2) military/aerospace, (3) any safety critical application – including life critical medical equipment – where the failure of the Fairchild product reasonably would be expected to result in personal injury, death or property damage. Customer's use of this product is subject to agreement of this Authorized Use policy. In the event of an unauthorized use of Fairchild's product, Fairchild accepts no liability in the event of product failure. In other respects, this product shall be subject to Fairchild's Worldwide Terms and Conditions of Sale, unless a separate agreement has been signed by both Parties.

**ANTI-COUNTERFEITING POLICY**

Fairchild Semiconductor Corporation's Anti-Counterfeiting Policy. Fairchild's Anti-Counterfeiting Policy is also stated on our external website, [www.fairchildsemi.com](http://www.fairchildsemi.com), under Terms of Use

Counterfeiting of semiconductor parts is a growing problem in the industry. All manufacturers of semiconductor products are experiencing counterfeiting of their parts. Customers who inadvertently purchase counterfeit parts experience many problems such as loss of brand reputation, substandard performance, failed applications, and increased cost of production and manufacturing delays. Fairchild is taking strong measures to protect ourselves and our customers from the proliferation of counterfeit parts. Fairchild strongly encourages customers to purchase Fairchild parts either directly from Fairchild or from Authorized Fairchild Distributors who are listed by country on our web page cited above. Products customers buy either from Fairchild directly or from Authorized Fairchild Distributors are genuine parts, have full traceability, meet Fairchild's quality standards for handling and storage and provide access to Fairchild's full range of up-to-date technical and product information. Fairchild and our Authorized Distributors will stand behind all warranties and will appropriately address any warranty issues that may arise. Fairchild will not provide any warranty coverage or other assistance for parts bought from Unauthorized Sources. Fairchild is committed to combat this global problem and encourage our customers to do their part in stopping this practice by buying direct or from authorized distributors.

**PRODUCT STATUS DEFINITIONS**

**Definition of Terms**

| Datasheet Identification | Product Status        | Definition  |
|--------------------------|-----------------------|---|
| Advance Information      | Formative / In Design | Datasheet contains the design specifications for product development. Specifications may change in any manner without notice.   |
| Preliminary              | First Production      | Datasheet contains preliminary data; supplementary data will be published at a later date. Fairchild Semiconductor reserves the right to make changes at any time without notice to improve design. |
| No Identification Needed | Full Production       | Datasheet contains final specifications. Fairchild Semiconductor reserves the right to make changes at any time without notice to improve the design.   |
| Obsolete                 | Not In Production     | Datasheet contains specifications on a product that is discontinued by Fairchild Semiconductor. The datasheet is for reference information only.  |

Rev. I77