

Features

- XTREMELY Low Jitter
- Low Cost
- XPRESS Delivery
- Frequency Resolution to six decimal places
- Stabilities to ± 25 PPM
- -20 to +70°C or -40 to +85°C operating temperatures
- Tri-State Enable / Disable Feature
- Industry Standard Package, Footprint & Pin-Out
- Fully RoHS and REACH compliant
- Gold over Nickel Termination Finish
- Serial ID with Comprehensive Traceability

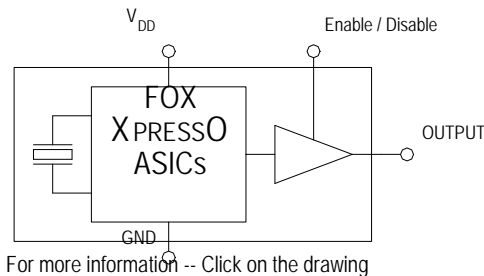

Description

The Fox XPRESSO Crystal Oscillator is a breakthrough in configurable Frequency Control Solutions. XPRESSO utilizes a family of proprietary ASICs, designed and developed by Fox, with a key focus on noise reduction technologies.

The 3rd order Delta Sigma Modulator reduces noise to the levels that are comparable to traditional Bulk Quartz and SAW oscillators. The ASICs family has ability to select the output type, input voltages, and temperature performance features.

With the XPRESS lead-time, low cost, low noise, wide frequency range, excellent ambient performance, XpressO is an excellent choice over the conventional technologies.

Finished XPRESSO parts are 100% final tested.



Applications

- ANY application requiring an oscillator
- SONET
- Ethernet
- Storage Area Network
- Broadband Access
- Microprocessors / DSP / FPGA
- Industrial Controllers
- Test and Measurement Equipment
- Fiber Channel

Contents

	page
Model Selection & Part Number Guide	2
Electrical Characteristics	3
Absolute Maximums	4
Output Wave Characteristics	4
Phase Noise	5
Jitter	5
Pin Assignment	6
Recommended Circuit	6
Reflow	6
Mechanical Drawing and Pad Layout	7
Tape and Reel Specification	8
Label	8
Traceability – LOT Number & Serial Identification	9
SGS Report	10~13
REACH Report	14~21
Mechanical Test	22
Burn-In Test	22
MTTF / FITS calculations	23
Other XPRESSO Links	24
Fox Contact Information	24

Model Selection Guide & Fox Part Number

STEP #1: Customer selects the Model Description and provides to Fox Customer Service
Model Description

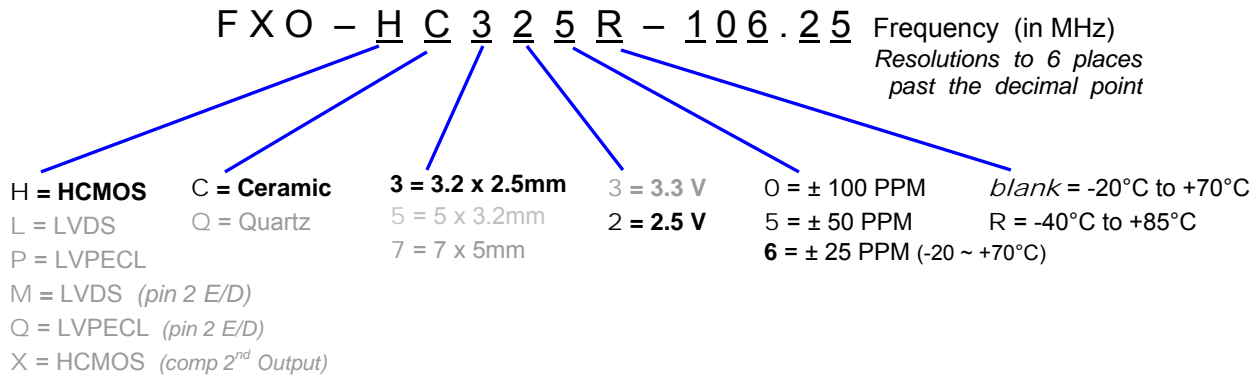

STEP #2: The Fox Customer Service team provides a customer specific Part Number for use on their Bill Of Materials (BOM).

Fox Part Number (The assigned Fox Part Number must be on the BOM – not the above Model Description)
 (This will ensure receipt of the proper part)

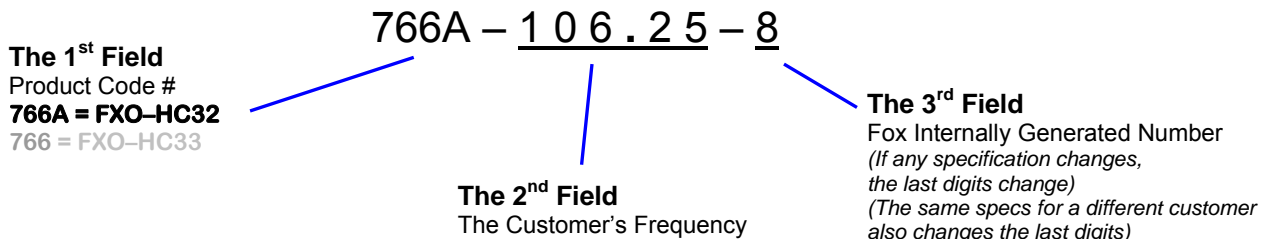

This example, **FXO-HC325R-106.25** = HCMOS Output, Ceramic 3.2 x 2.5mm Package, 2.5V, ±50 PPM Stability, -40 to +85°C Temperature Range, at 106.25 MHz

Electrical Characteristics			
Parameters	Symbol	Condition	Maximum Value (unless otherwise noted)
Frequency Range	F_O		0.750 to 180.000 MHz
Frequency Stability ¹		-20 ~ +70°C -40 to +85°C	100, 50, 25* PPM 100, 50 PPM
Temperature Range	T_O T_{STG}	Standard operating <i>Optional operating</i> Storage	-20°C to +70°C -40°C to +85°C -55°C to +125°C
Supply Voltage	V_{DD}	Standard	2.5 V ± 5%
Input Current (@ 15pF LOAD)	I_{DD}	0.75 ~ 20 MHz 20+ ~ 50 MHz 50+ ~ 100 MHz 100+ ~ 130 MHz 130+ ~ 160 MHz 160+ ~ 180 MHz	22 mA 25 mA 29 mA 32 mA 35 mA 37 mA
Output Load	HCMOS	Standard	15 pF
Start-Up Time	T_s		10 mS
Output Enable / Disable Time			100 nS
Moisture Sensitivity Level	MSL	JEDEC J-STD-20	1
Termination Finish			Au

¹Inclusive of 25°C tolerance, operating temperature range, input voltage change, load change, aging, shock and vibration. *Excludes aging.

Absolute Maximum Ratings			
<i>(Useful life may be impaired. For user guidelines only, not tested)</i>			
<i>Operation is only guaranteed for voltage and temperature specifications in Electrical Characteristics section.)</i>			
Parameters	Symbol	Condition	Maximum Value (unless otherwise noted)
Input Voltage	V_{DD}		-0.5V to +5.0V
Operating Temperature	T_{AMAX}		-55°C to +105°C
Storage Temperature	T_{STG}		-55°C to +125°C
Junction Temperature			125°C
ESD Sensitivity	HBM	Human Body Model	> 1 kV

Output Wave Characteristics

Parameters	Symbol	Condition	Maximum Value (unless otherwise noted)
Output LOW Voltage	V_{OL}	0.75 to 160 MHz 160+ to 180 MHz	10% V_{DD} 20% V_{DD}
Output HIGH Voltage	V_{OH}	0.75 to 160 MHz 160+ to 180 MHz	90% V_{DD} MIN 80% V_{DD} MIN
Output Symmetry (See Drawing Below)		@ 50% V_{DD} Level	45% ~ 55%
Output Enable (PIN # 1) Voltage	V_{IH}		$\geq 70\% V_{DD}$
Output Disable (PIN # 1) Voltage	V_{IL}		$\leq 30\% V_{DD}$
Cycle Rise Time (See Drawing Below)	T_R	0.75 to 160 MHz 160+ to 180 MHz	3.5 nS (10%~90%) 2.5 nS (20%~80%)
Cycle Fall Time (See Drawing Below)	T_F	0.75 to 160 MHz 160+ to 180 MHz	3.5 nS (90%~10%) 2.5 nS (80%~20%)

If 30% to 70% times are used, Rise and Fall times change to 2 nS from 0.75 to 180MHz
 If 20% to 80% times are used, Rise and Fall times change to 2.5 nS from 0.75 to 160MHz

Rise Time / Fall Time Measurements

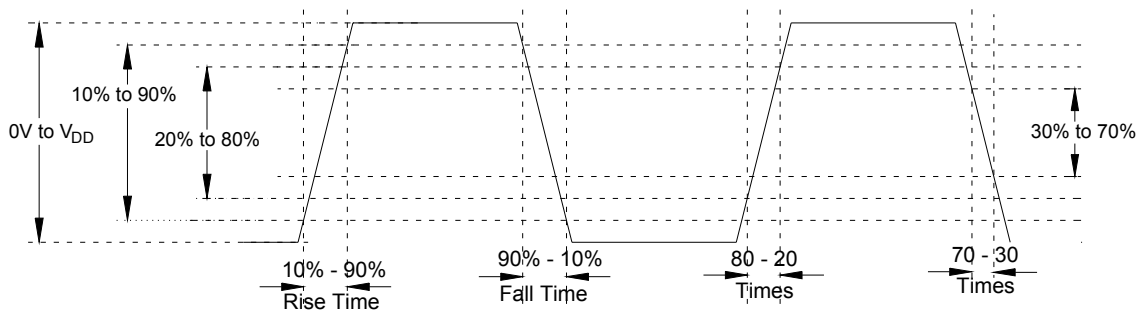

Oscillator Symmetry

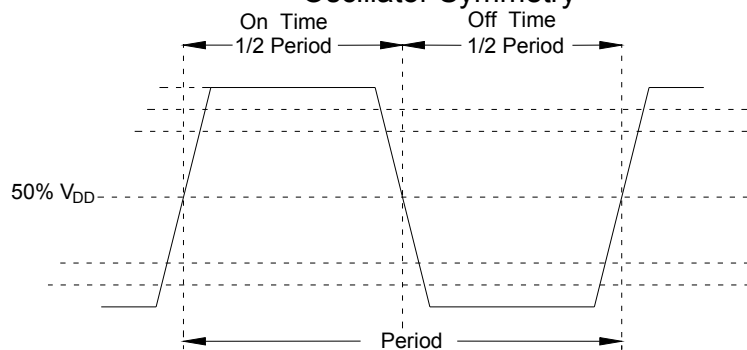

Ideally, Symmetry should be 50/50 -- Other expressions are 45/55 or 55/45

Phase Noise

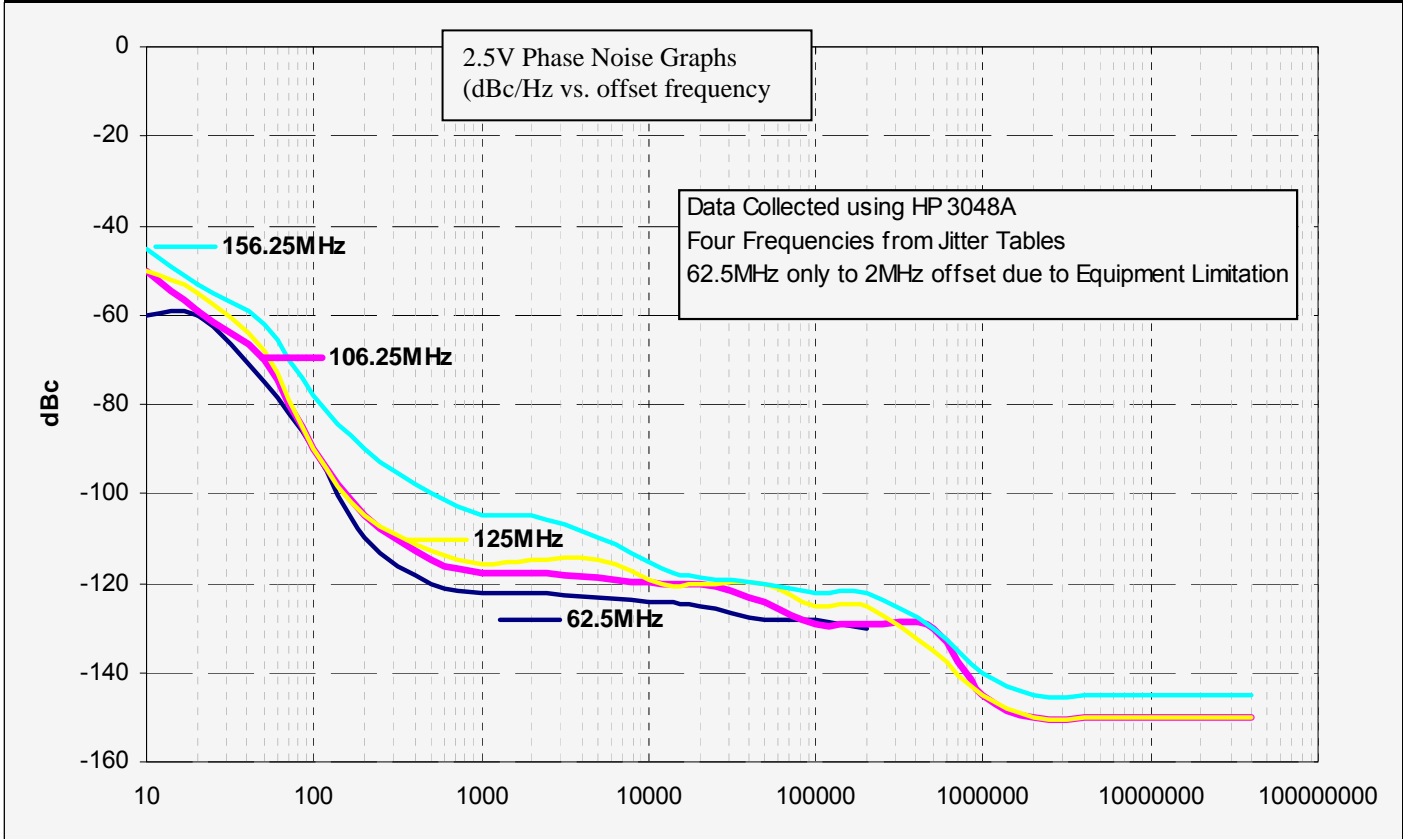

Jitter is frequency dependent. Below are typical values at select frequencies.

Phase Jitter & Time Interval Error (TIE)			
Frequency	Phase Jitter (12kHz to 20MHz)	TIE (Sigma of Jitter Distribution)	Units
62.5 MHz	0.9	2.9	pS RMS
106.25 MHz	0.8	3.5	pS RMS
125 MHz	0.8	2.5	pS RMS
156.25 MHz	0.9	3.1	pS RMS

Phase Jitter is integrated from HP3048 Phase Noise Measurement System; measured directly into 50 ohm input; $V_{DD} = 2.5V$.

TIE was measured on LeCroy LC684 Digital Storage Scope, directly into 50 ohm input, with Amherst M1 software; $V_{DD} = 2.5V$.

Per **MJSQ spec** (Methodologies for Jitter and Signal Quality specifications)

Random & Deterministic Jitter Composition			
Frequency	Random (Rj) (pS RMS)	Deterministic (Dj) (pS P-P)	Total Jitter (Tj) (14 x Rj) + Dj
62.5 MHz	1.3	9.2	28.4 pS
106.25 MHz	1.3	9.0	27.2 pS
125 MHz	1.3	8.8	27.7 pS
156.25 MHz	1.4	10.4	30.3 pS

Ri and Dj, measured on LeCroy LC684 Digital Storage Scope, directly into 50 ohm input, with Amherst M1 software. Per **MJSQ spec** (Methodologies for Jitter and Signal Quality specifications)



Pin Description and Recommended Circuit

Pin #	Name	Type	Function
1	E / D ¹	Logic	Enable / Disable Control of Output (0 = Disabled)
2	GND	Ground	Electrical Ground for V _{DD}
3	Output	Output	HCMOS Oscillator Output
4	V _{DD} ²	Power	Power Supply Source Voltage
Test Points	N. C.	Hi Z	No Connection (Factory Use ONLY)

NOTES:

- Includes pull-up resistor to V_{DD} to provide output when the pin (1) is No Connect.
- Installation should include a 0.01μF bypass capacitor placed between V_{DD} (Pin 4) and GND (Pin 2) to minimize power supply line noise.

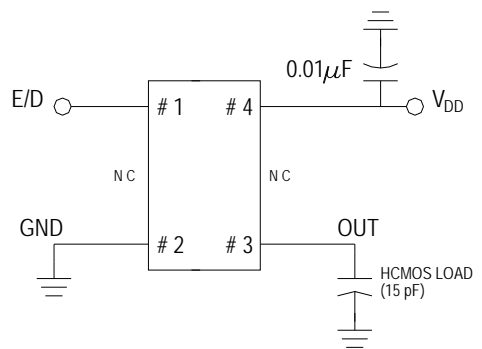
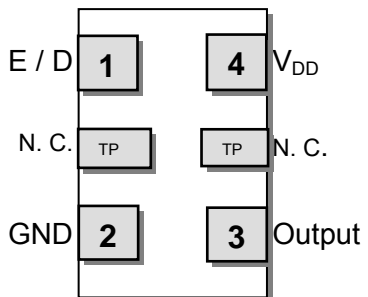

Terminations as viewed from the Top

NOTE: XPRESSO HCMOS XO's are designed to fit on Industry Standard, 4 pad layouts

Enable / Disable Control

Pin # 1 (state)	Output (Pin # 3)
OPEN (No Connection)	ACTIVE Output
"1" Level $V_{IH} \geq 70\% V_{DD}$	ACTIVE Output
"0" Level $V_{IL} \leq 30\% V_{DD}$	High Impedance

Soldering Reflow Profile (2 times Maximum at 260°C for 10 seconds MAX)

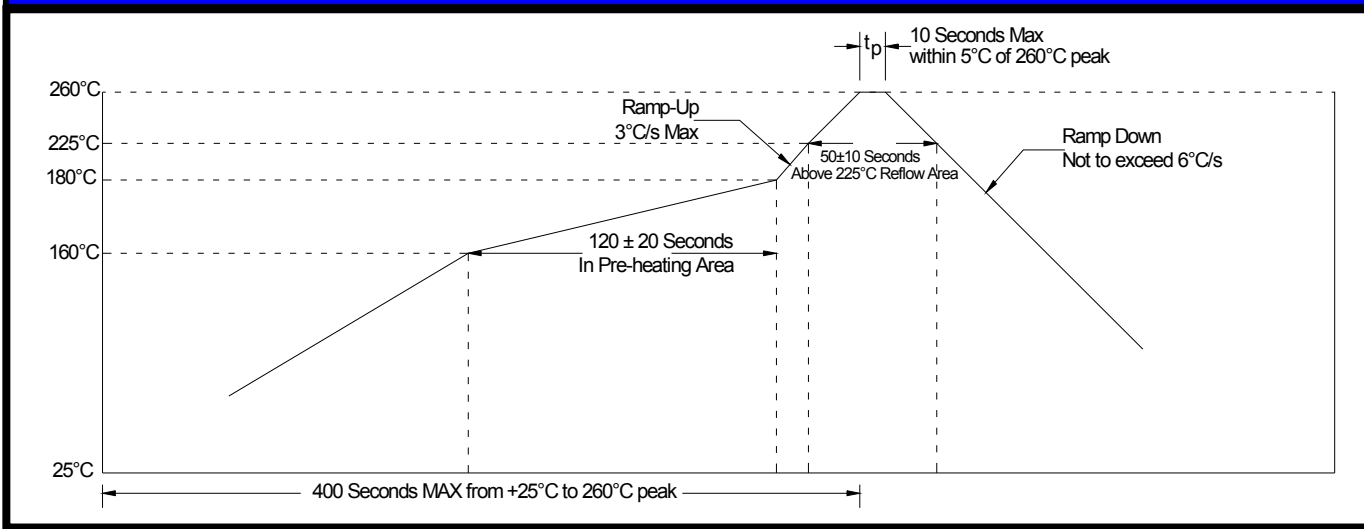

Mechanical Dimensional Drawing & Pad Layout

**3.2 x 2.5 XpressO
HCMOS**

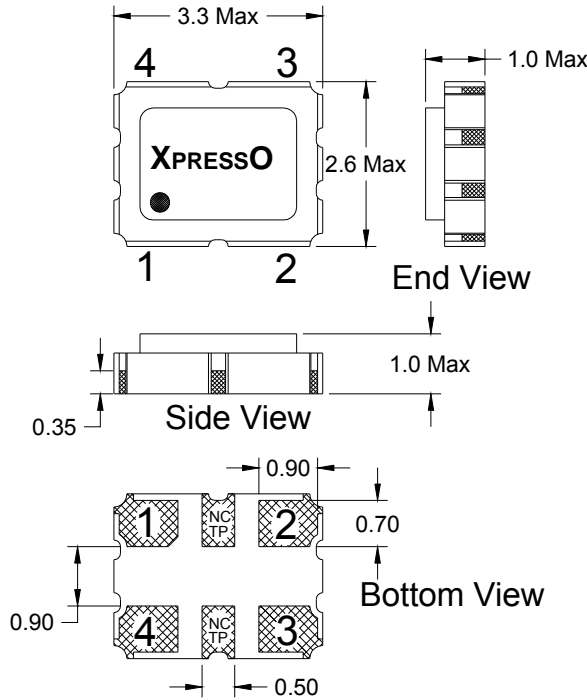

**Actual part marking
is depicted.**

See **Traceability** (pg. 8)
for more information

**Recommended
Solder Pad Layout**

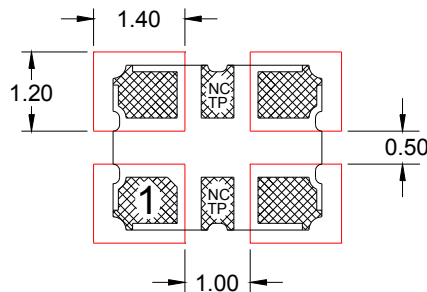

Note: XpressO HCMOS XO's are designed to fit on industry standard, 4 pad layouts.

Pin Connections

- # 1 E / D # 3 Output
- # 2 GND # 4 V_{DD}

Drawing is for reference to critical specifications defined by size measurements.
Certain non-critical visual attributes, such as side castellations, reference pin shape, etc. may vary

Tape and Reel Dimensions (mm)

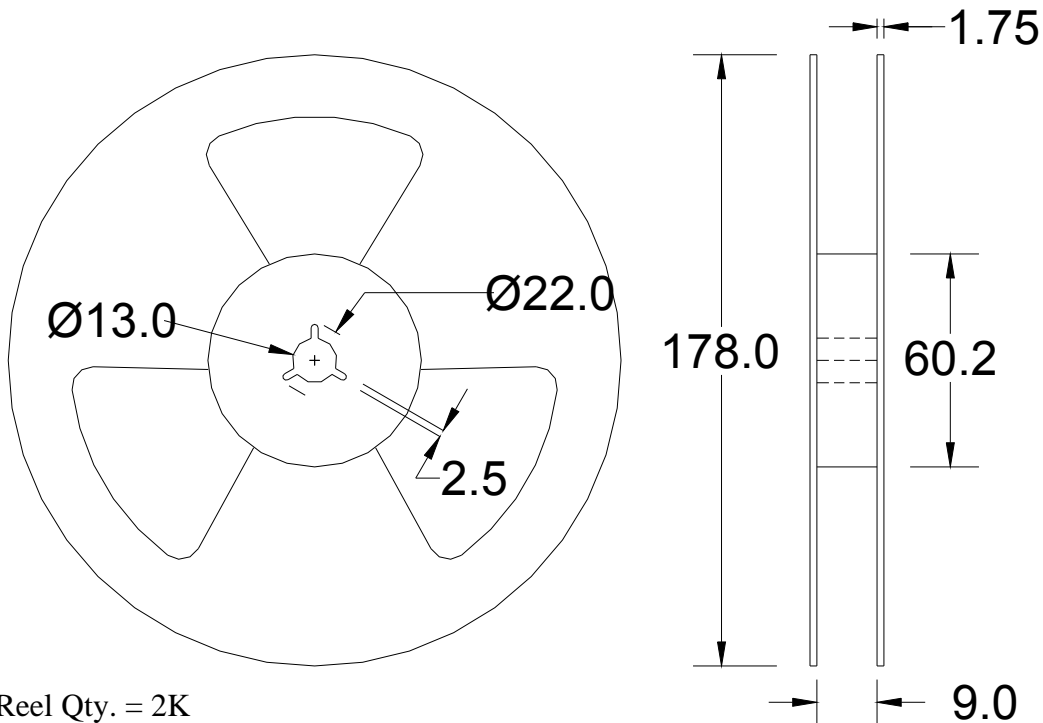
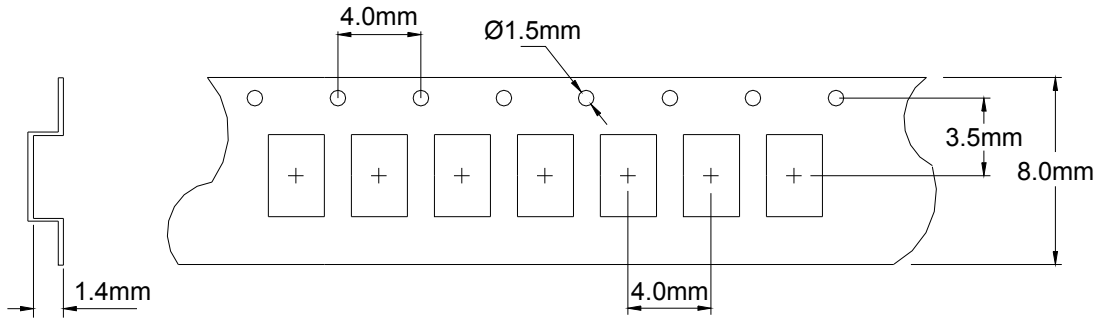

Standard Reel Qty. = 2K

Labeling (Reels and smaller packaging are labeled with the below)

- Fox Part Number: **766A-106.25-8** →
- Quantity: **2000 pieces** →
- Description: **FXO-HC325R-106.25** →
- Date Code: **0745** →
(YYWW 2007 45th wk)
- LOT #: **24435** →
If traceability should become necessary

An additional identification code is contained internally if tracking should ever be necessary

Traceability – LOT Number & Serial Identification

LOT Number

The LOT Number has direct ties to the customer purchase order. The LOT Number is marked on the “Reel” label, and also stored internally on non-volatile memory inside the XPRESSO part. XPRESSO parts that are shipped Tape and Reel, are also placed in an Electro Static Discharge (ESD) bag and will have the LOT Number labeled on the exterior of the ESD bag.

It is recommended that the XPRESSO parts remain in this ESD bag during storage for protection and identification.

If the parts become separated from the label showing the LOT Number, it can be retrieved from inside one of the parts, and the information that can be obtained is listed below:

- Customer Purchase Order Number
- Internal Fox Sales Order Number
- Dates that the XPRESSO part was shipped from the factory
- The assigned customer part number
- The specification that the part was designed for

Serial Identification

The Serial ID is the individualized information about the configuration of that particular XPRESSO part. The Serial ID is unique for each and every XPRESSO part, and can be read by special Fox equipment.

With the Serial ID, the below information can be obtained about that individual, XPRESSO part:

- Equipment that the XPRESSO part was configured on
- Raw material used to configure the XPRESSO part
- Traceability of the raw material back to the foundries manufacturing lot
- Date and Time that the part was configured
- Any optimized electrical parameters based on customer specifications
- Electrical testing of the actual completed part
- Human resource that was monitoring the configuration of the part

Fox has equipment placed at key Fox locations World Wide to read the Lot Identification and Serial Number of any XPRESSO part produced and can then obtain the information from above within 24 hours.

3rd Party (SGS) Material Report



Test Report

No. : CE/2009/B5581 Date : 2009/11/27 Page : 1 of 4

FOX ELECTRONICS
5570 ENTERPRISE PARKWAY FT. MYERS, FL 33905, USA



The following sample(s) was/were submitted and identified by/on behalf of the client as:

Sample Description	:	XPRESSO CLOCK OSCILLATORS
Style/Item No.	:	SEAM SEAL CERAMIC PACKAGE
Buyer/Order No.	:	51173
Sample Receiving Date	:	2009/11/20
Testing Period	:	2009/11/20 TO 2009/11/27

Test Result(s) : Please refer to next page(s).

Chenyu Kung / Operation Manager
Signed for and on behalf of
SGS TAIWAN LTD.
Chemical Laboratory – Taipei

Unless otherwise stated the results shown in this test report refer only to the sample(s) tested. This test report cannot be reproduced, except in full, without prior written permission of the Company.
除非另有說明，此報告結果僅對測試之樣品負責。本報告未經本公司書面許可，不可部分複製。
This Test Report is issued by the Company under its General Conditions of Service printed overleaf or available on request and accessible at http://www.sgs.com/terms_and_conditions.htm. Attention is drawn to the limitation of liability, indemnification and jurisdiction issues defined therein. Any holder of this Test Report is advised that information contained hereon reflects the Company's findings at the time of its intervention only and within the limits of Client's instructions, if any. The Company's sole responsibility is to its Client and this document does not exonerate parties to a transaction from exercising all their rights and obligations under the transaction documents. Any unauthorized alteration, forgery or falsification of the content or appearance of this document is unlawful and offenders may be prosecuted to the fullest extent of the law.

SGS Taiwan Ltd. | Chemical-Taipei | 33 Wuchuan Road, Wuku Industrial Zone, Taipei County, Taiwan / 台北縣五權工業區五權路33號 | + 886 (02)2299 3279 | + 886 (02)2299 3237 | www.sgs.com
台灣檢驗科技股份有限公司

Member of the SGS Group (SGS SA)



3rd Party (SGS) Material Report



Test Report

No. : CE/2009/B5581 Date : 2009/11/27 Page : 2 of 4

FOX ELECTRONICS
5570 ENTERPRISE PARKWAY FT. MYERS, FL 33905, USA



Test Result(s)

PART NAME NO.1 : OSCILLATORS

Test Item (s):	Unit	Method	MDL	Result
				NO.1
Cadmium (Cd)	mg/kg	With reference to IEC 62321: 2008 and performed by ICP-AES.	2	n.d.
Lead (Pb)	mg/kg	With reference to IEC 62321: 2008 and performed by ICP-AES.	2	n.d.
Mercury (Hg)	mg/kg	With reference to IEC 62321: 2008 and performed by ICP-AES.	2	n.d.
Hexavalent Chromium Cr(VI) by alkaline extraction	mg/kg	With reference to IEC 62321: 2008 and performed by UV-VIS.	2	n.d.
Perfluorooctane sulfonates (PFOS) PFOS – Acid PFOS – Metal Salt PFOS – Amide	mg/kg	With reference to US EPA 3540C: 1996 method for PFOS Content. Analysis was performed by LC/MS.	10	n.d.
PFOA (CAS No.: 000335-67-1)	mg/kg	With reference to US EPA 3540C: 1996 method for PFOA Content. Analysis was performed by LC/MS.	10	n.d.
Halogen				
Halogen-Fluorine (F) (CAS No.: 014762-94-8)	mg/kg	With reference to BS EN 14582:2007. Analysis was performed by IC.	50	n.d.
Halogen-Chlorine (Cl) (CAS No.: 022537-15-1)	mg/kg	With reference to BS EN 14582:2007. Analysis was performed by IC.	50	n.d.
Halogen-Bromine (Br) (CAS No.: 010097-32-2)	mg/kg	With reference to BS EN 14582:2007. Analysis was performed by IC.	50	n.d.
Halogen-Iodine (I) (CAS No.: 014362-44-8)	mg/kg	With reference to BS EN 14582:2007. Analysis was performed by IC.	50	n.d.

Unless otherwise stated the results shown in this test report refer only to the sample(s) tested. This test report cannot be reproduced, except in full, without prior written permission of the Company.
除非另有說明，此報告結果僅對測試之樣品負責。本報告未經本公司書面許可，不可部分複製。

This Test Report is issued by the Company under its General Conditions of Service printed overleaf or available on request and accessible at http://www.sgs.com/terms_and_conditions.htm. Attention is drawn to the limitation of liability, indemnification and jurisdiction issues defined therein. Any holder of this Test Report is advised that information contained hereon reflects the Company's findings at the time of its intervention only and within the limits of Client's instructions, if any. The Company's sole responsibility is to its Client and this document does not exonerate parties to a transaction from exercising all their rights and obligations under the transaction documents. Any unauthorized alteration, forgery or falsification of the content or appearance of this document is unlawful and offenders may be prosecuted to the fullest extent of the law.

SGS Taiwan Ltd. Chemical-Taipei 33 Wuchuan Road, Wuku Industrial Zone, Taipei County, Taiwan / 台北縣五股工業區五權路33號 1 + 886 (02)2299 3279 F + 886 (02)2299 3237 www.sgs.com
台灣檢驗科技股份有限公司

Member of the SGS Group (SGS SA)



3rd Party (SGS) Material Report



Test Report

No. : CE/2009/B5581 Date : 2009/11/27 Page : 3 of 4

FOX ELECTRONICS
5570 ENTERPRISE PARKWAY FT. MYERS, FL 33905, USA



Test Item (s):	Unit	Method	MDL	Result NO.1
Sum of PBBs	mg/kg	With reference to IEC 62321: 2008 and performed by GC/MS.	-	n.d.
Monobromobiphenyl			5	n.d.
Dibromobiphenyl			5	n.d.
Tribromobiphenyl			5	n.d.
Tetrabromobiphenyl			5	n.d.
Pentabromobiphenyl			5	n.d.
Hexabromobiphenyl			5	n.d.
Heptabromobiphenyl			5	n.d.
Octabromobiphenyl			5	n.d.
Nonabromobiphenyl			5	n.d.
Decabromobiphenyl			5	n.d.
Sum of PBDEs			-	n.d.
Monobromodiphenyl ether			5	n.d.
Dibromodiphenyl ether			5	n.d.
Tribromodiphenyl ether			5	n.d.
Tetrabromodiphenyl ether			5	n.d.
Pentabromodiphenyl ether			5	n.d.
Hexabromodiphenyl ether			5	n.d.
Heptabromodiphenyl ether			5	n.d.
Octabromodiphenyl ether			5	n.d.
Nonabromodiphenyl ether			5	n.d.
Decabromodiphenyl ether			5	n.d.

Note :

1. mg/kg = ppm ; 0.1wt% = 1000ppm
2. n.d. = Not Detected
3. MDL = Method Detection Limit
4. " - " = Not Regulated

PFOS Reference Information : Directive 2006/122/EC

- (1) May not be placed on the market or used as a substance or constituent of preparations in a concentration equal to or higher than 0.005 % by mass.
- (2) May not be placed on the market in semi-finished products or articles, or parts thereof, if the concentration of PFOS is equal to or higher than 0.1 % by mass calculated with reference to the mass of structurally or microstructurally distinct parts that contain PFOS or, for textiles or other coated materials, if the amount of PFOS is equal to or higher than 1µg/m² of the coated material.

Unless otherwise stated the results shown in this test report refer only to the sample(s) tested. This test report cannot be reproduced, except in full, without prior written permission of the Company.
除非另有說明，此報告結果僅對測試之樣品負責。本報告未經本公司書面許可，不可部分複製。
This Test Report is issued by the Company under its General Conditions of Service printed overleaf or available on request and accessible at http://www.sgs.com/tams_and_conditions.htm. Attention is drawn to the limitation of liability, indemnification and jurisdiction issues defined therein. Any holder of this Test Report is advised that information contained hereon reflects the Company's findings at the time of its intervention only and within the limits of Client's instructions, if any. The Company's sole responsibility is to its Client and this document does not exonerate parties to a transaction from exercising all their rights and obligations under the transaction documents. Any unauthorized alteration, forgery or falsification of the content or appearance of this document is unlawful and offenders may be prosecuted to the fullest extent of the law.

SGS Taiwan Ltd.
台灣檢驗科技股份有限公司 Chemical-Taipei 33 WuChyuan Road, Wuku Industrial Zone, Taipei County, Taiwan /台北縣五股工業區五權路33號 t + 886 (02)2299 3279 f + 886 (02)2299 3237 www.sgs.com

Member of the SGS Group (SGS SA)



3rd Party (SGS) Material Report



Test Report

No. : CE/2009/B5581 Date : 2009/11/27 Page : 4 of 4

FOX ELECTRONICS
5570 ENTERPRISE PARKWAY FT. MYERS, FL 33905, USA



** End of Report **

Unless otherwise stated the results shown in this test report refer only to the sample(s) tested. This test report cannot be reproduced, except in full, without prior written permission of the Company.
除非另有說明，此報告結果僅對測試之樣品負責。本報告未經本公司書面許可，不可部分複製。
This Test Report is issued by the Company under its General Conditions of Service printed overleaf or available on request and accessible at http://www.sgs.com/terms_and_conditions.htm. Attention is drawn to the limitation of liability, indemnification and jurisdiction issues defined therein. Any holder of this Test Report is advised that information contained hereon reflects the Company's findings at the time of its intervention only and within the limits of Client's instructions, if any. The Company's sole responsibility is to its Client and this document does not exonerate parties to a transaction from exercising all their rights and obligations under the transaction documents. Any unauthorized alteration, forgery or falsification of the content or appearance of this document is unlawful and offenders may be prosecuted to the fullest extent of the law.

SGS Taiwan Ltd. Chemical-Taipei 33 Wuchuan Road, Wuku Industrial Zone, Taipei County, Taiwan / 台北縣五股工業區五權路33號 1 + 886 (02)2209 3279 f + 886 (02)2209 3237 www.sgs.com
台灣檢驗科技股份有限公司

Member of the SGS Group (SGS SA)





Test Report (SVHC)

No. : CR/2009/B0181 Date : 2009/11/27 Page : 1 of 8

FOX ELECTRONICS
5570 ENTERPRISE PARKWAY FT. MYERS, FL 33905, USA



The following sample(s) was/were submitted and identified by/on behalf of the client as :

Sample Description : XPRESSO CLOCK OSCILLATORS
 Style/Item No. : SEAM SEAL CERAMIC PACKAGE
 Buyer/Order No. : 51173
 Sample Receiving Date : 2009/11/20
 Testing Period : 2009/11/20 TO 2009/11/27

Test Requested : Fifteen (15) Substances of Very High Concern (SVHC) screening in addition of Cyclododecane by specific client's request. SVHC candidate list based on the publication by European Chemicals Agency (ECHA) on 2008 October 28, regarding Regulation (EC) No 1907/2006 concerning the REACH.

Test Method : Please refer to next page(s).

Test Result(s) : Please refer to next page(s).

Summary : According to the specified scope and analytical technique, concentrations of all SVHC are <0.1% in the submitted sample(s).

Chenyu Kung / Operation Manager
Signed for and on behalf of
SGS TAIWAN LTD.
Chemical Laboratory – Taipei

Unless otherwise stated the results shown in this test report refer only to the sample(s) tested. This test report cannot be reproduced, except in full, without prior written permission of the Company.
 除非另有說明，此報告結果僅對測試之樣品負責。本報告未經本公司書面許可，不可部分複製。
 This Test Report is issued by the Company under its General Conditions of Service printed overleaf or available on request and accessible at http://www.sgs.com/terms_and_conditions.htm. Attention is drawn to the limitation of liability, indemnification and jurisdiction issues defined therein. Any holder of this Test Report is advised that information contained hereon reflects the Company's findings at the time of its intervention only and within the limits of Client's instructions, if any. The Company's sole responsibility is to its Client and this document does not exonerate parties to a transaction from exercising all their rights and obligations under the transaction documents. Any unauthorized alteration, forgery or falsification of the content or appearance of this document is unlawful and offenders may be prosecuted to the fullest extent of the law.





Test Report (SVHC)

No. : CR/2009/B0181 Date : 2009/11/27 Page : 2 of 8

FOX ELECTRONICS
5570 ENTERPRISE PARKWAY FT. MYERS, FL 33905, USA



Test Sample : OSCILLATORS

Test Method : SGS In-House method-RSTS-EE-SVHC-002. Analyzed by ICP-AES, UV-VIS, GC/MS and GC/FPD.

Remark:

1. The chemical analysis of 15 SVHC is performed by means of currently available analytical techniques against the list published by ECHA on 2008 October 28. This list is under evaluation by ECHA and may subject to change in the future.
Please refer to http://echa.europa.eu/consultations/authorisation/svhc/svhc_cons_en.asp
2. In accordance with Regulation (EC) No 1907/2006, any producer or importer of articles shall notify ECHA, in accordance with paragraph 2 of Article 7, if a substance meets the criteria in Article 57 and is identified in accordance with Article 59(1) of the Regulation, if (a) the substance is present in those articles in quantities totaling over one tonne per producer or importer per year; and (b) the substance is present in those articles above a concentration of 0.1% weight by weight (w/w).
3. Article 33 of Regulation (EC) No 1907/2006 requires supplier of an article containing a substance meeting the criteria in Article 57 and identified in accordance with Article 59(1) in a concentration above 0.1% weight by weight (w/w) shall provide the recipient of the article with sufficient information, available to the supplier, to allow safe use of the article including, as a minimum, the name of that substance.
4. If a SVHC is found over the reporting limit, client is suggested to identify the component which contains the SVHC and the exact concentration of the SVHC by requesting further quantitative analysis from the laboratory.

Test Result(s)

Substance Name	Unit	Concentration of Article	RL	Classification
Anthracene (CAS No.: 000120-12-7)	%	n.d.	0.005	PBT
4,4' - Diaminodiphenylmethane (CAS No.: 000101-77-9)	%	n.d.	0.005	Carcinogen Category 2
DBP (Dibutyl phthalate) (CAS No.: 000084-74-2)	%	n.d.	0.005	Toxic to Reproduction Category 2
BBP (Benzyl butyl phthalate) (CAS No.: 000085-68-7)	%	n.d.	0.005	Toxic to Reproduction Category 2
DEHP (Di- (2-ethylhexyl) phthalate) (CAS No.: 000117-81-7)	%	n.d.	0.005	Toxic to Reproduction Category 2
5-tert-butyl-2,4,6-trinitro- m-xylene (Musk Xylene) (CAS No.: 000081-15-2)	%	n.d.	0.005	vPvB

Unless otherwise stated the results shown in this test report refer only to the sample(s) tested. This test report cannot be reproduced, except in full, without prior written permission of the Company.
除非另有說明，此報告結果僅對測試之樣品負責。本報告未經本公司書面許可，不可部分複製。
This Test Report is issued by the Company under its General Conditions of Service printed overleaf or available on request and accessible at http://www.sgs.com/terms_and_conditions.htm. Attention is drawn to the limitation of liability, indemnification and jurisdiction issues defined therein. Any holder of this Test Report is advised that information contained hereon reflects the Company's findings at the time of its intervention only and within the limits of Client's instructions, if any. The Company's sole responsibility is to its Client and this document does not exonerate parties to a transaction from exercising all their rights and obligations under the transaction documents. Any unauthorized alteration, forgery or falsification of the content or appearance of this document is unlawful and offenders may be prosecuted to the fullest extent of the law.

SGS Taiwan Ltd.
台灣檢驗科技股份有限公司 | Chemical-Taipei 33 WuChyuan Road, Wuku Industrial Zone, Taipei County, Taiwan / 台北縣五股工業區五權路33號 1 + 886 (02)2299 3279 f + 886 (02)2299 3237 www.sgs.com

Member of the SGS Group (SGS SA)





Test Report (SVHC)

No. : CR/2009/B0181 Date : 2009/11/27 Page : 3 of 8

FOX ELECTRONICS
5570 ENTERPRISE PARKWAY FT. MYERS, FL 33905, USA



Substance Name	Unit	Concentration of Article	RL	Classification
Hexabromocyclododecane (HBCDD) and all major diastereoisomers identified (α-HBCDD, β- HBCDD, γ- HBCDD) (CAS No.: 025637-99-4 and 003194-55-6 (134237-51-7, 134237-50-6, 134237-52-8))	%	n.d.	0.005	PBT
Alkanes, C10-13, chloro (Short Chain Chlorinated Paraffins) (CAS No.: 085535-84-8)	%	n.d.	0.01	PBT
Bis(tributyltin)oxide*** (CAS No.: 000056-35-9)	%	n.d.	-	PBT
Cobalt dichloride (CAS No.: 007646-79-9)	%	n.d.	0.05	Carcinogen Category 2
Diarsenic pentaoxide*** (CAS No.: 001303-28-2)	%	n.d.	-	Carcinogen Category 1
Diarsenic trioxide*** (CAS No.: 001327-53-3)	%	n.d.	-	Carcinogen Category 1
Triethyl arsenate***(CAS No.: 015606-95-8)	%	n.d.	-	Carcinogen Category 1
Lead hydrogen arsenate*** (CAS No.: 007784-40-9)	%	n.d.	-	Carcinogen Category 1; Toxic to Reproduction Category 1
Sodium dichromate*** (CAS No.: 010588-01-9(**))	%	n.d.	-	Carcinogen Category 2; Mutagen Category 2; Toxic to Reproduction Category 2

Additional screening by client's request outside the scope of SVHC as published by ECHA on 2008 October 28:

Substance Name	Unit	Concentration of Article	RL	Classification
Cyclododecane (CAS No.: 000294-62-2)	%	n.d.	0.005	PBT

Unless otherwise stated the results shown in this test report refer only to the sample(s) tested. This test report cannot be reproduced, except in full, without prior written permission of the Company.
除非另有說明，此報告結果僅對測試之樣品負責。本報告未經本公司書面許可，不可部分複製。
This Test Report is issued by the Company under its General Conditions of Service printed overleaf or available on request and accessible at http://www.sgs.com/taipei_and_conditions.htm. Attention is drawn to the limitation of liability, indemnification and jurisdiction issues defined therein. Any holder of this Test Report is advised that information contained hereon reflects the Company's findings at the time of its intervention only and within the limits of Client's instructions, if any. The Company's sole responsibility is to its Client and this document does not exonerate parties to a transaction from exercising all their rights and obligations under the transaction documents. Any unauthorized alteration, forgery or falsification of the content or appearance of this document is unlawful and offenders may be prosecuted to the fullest extent of the law.

SGS Taiwan Ltd. Chemical-Taipei 33 WuChyuan Road, Wuku Industrial Zone, Taipei County, Taiwan /台北縣五股工業區五權路33號 t + 886 (02)2299 3279 f + 886 (02)2299 3237 www.sgs.com
台灣檢驗科技股份有限公司

Member of the SGS Group (SGS SA)





Test Report (SVHC)

No. : CR/2009/B0181 Date : 2009/11/27 Page : 4 of 8

FOX ELECTRONICS
5570 ENTERPRISE PARKWAY FT. MYERS, FL 33905, USA



Note :

1. mg/kg = ppm; 0.1wt% = 1000ppm
2. n.d.= not detected = below Reporting Limit
3. RL = Reporting Limit
4. Definition of classification is listed in Appendix A of this report in accordance with 67/548/EEC and Regulation (EC) No 1907/2006.
5. Please refer to Appendix C to find the concentration and the weight of each tested unit.
6. " - " = Not Regulated
7. ***: The substance was calculated by the test results of Tributyl Tin or element (Ex. Arsenic, Lead or Cr(VI) respectively).

$$AX = A \times F$$

AX	A	F
Diarsenic pentaoxide	Arsenic	1.5339
Diarsenic trioxide		1.3203
Triethyl arsenate		3.0179
Lead hydrogen arsenate	Lead	4.6332
Sodium dichromate		1.6753
	Hexavalent Chromium Cr(VI)	2.5192
Bis(tributyltin)oxide	Tributyl Tin (TBT)	1.0276

Regarding lead hydrogen arsenate lead and arsenic are tested and used for the calculation of the separated concentration of lead hydrogen arsenate. The final concentration of lead hydrogen arsenate for the report uses the minimum value of above-mentioned two concentration of lead hydrogen arsenate.

The test result is given as:

Substance Name	Unit	Concentration of Article	RL
Tributyl Tin (TBT)	%	n.d.	0.005
Arsenic (As)	%	n.d.	0.005
Lead (Pb)	%	n.d.	0.005
Hexavalent Chromium Cr(VI)	%	n.d.	0.005

8. (*): conc. of Sodium dichromate dihydrate (CAS No.: 007789-12-0) = conc. of sodium dichromate × 1.1374

Unless otherwise stated the results shown in this test report refer only to the sample(s) tested. This test report cannot be reproduced, except in full, without prior written permission of the Company.
 除非另有說明，此報告結果僅對測試之樣品負責，本報告未經本公司書面許可，不可部分複製。
 This Test Report is issued by the Company under its General Conditions of Service printed overleaf or available on request and accessible at http://www.sgs.com/tamc_and_conditions.htm. Attention is drawn to the limitation of liability, indemnification and jurisdiction issues defined therein. Any holder of this Test Report is advised that information contained hereon reflects the Company's findings at the time of its intervention only and within the limits of Client's instructions, if any. The Company's sole responsibility is to its Client and this document does not exonerate parties to a transaction from exercising all their rights and obligations under the transaction documents. Any unauthorized alteration, forgery or falsification of the content or appearance of this document is unlawful and offenders may be prosecuted to the fullest extent of the law.





**Test Report
(SVHC)**

No. : CR/2009/B0181 Date : 2009/11/27 Page : 5 of 8

FOX ELECTRONICS
5570 ENTERPRISE PARKWAY FT. MYERS, FL 33905, USA



Unless otherwise stated the results shown in this test report refer only to the sample(s) tested. This test report cannot be reproduced, except in full, without prior written permission of the Company.
除非另有說明，此報告結果僅對測試之樣品負責。本報告未經本公司書面許可，不可部分複製。
This Test Report is issued by the Company under its General Conditions of Service printed overleaf or available on request and accessible at http://www.sgs.com/terms_and_conditions.htm. Attention is drawn to the limitation of liability, indemnification and jurisdiction issues defined therein. Any holder of this Test Report is advised that information contained hereon reflects the Company's findings at the time of its intervention only and within the limits of Client's instructions, if any. The Company's sole responsibility is to its Client and this document does not exonerate parties to a transaction from exercising all their rights and obligations under the transaction documents. Any unauthorized alteration, forgery or falsification of the content or appearance of this document is unlawful and offenders may be prosecuted to the fullest extent of the law.

SGS Taiwan Ltd. Chemical-Taipei 33 WuChyuan Road, Wuku Industrial Zone, Taipei County, Taiwan /台北縣五股工業區五權路33號 t + 886 (02)2299 3279 f + 886 (02)2299 3237 www.sgs.com
台灣檢驗科技股份有限公司

Member of the SGS Group (SGS SA)





**Test Report
(SVHC)**

No. : CR/2009/B0181 Date : 2009/11/27 Page : 6 of 8

FOX ELECTRONICS
5570 ENTERPRISE PARKWAY FT. MYERS, FL 33905, USA



[Appendix A]

Classification	Definition under 67/548/EEC and Regulation (EC) No 1907/2006
Carcinogen Category 1:	Substances known to be carcinogenic to man. There is sufficient evidence to establish a causal association between human exposure to a substance and the development of cancer.
Carcinogen Category 2:	Substances which should be regarded as if they are carcinogenic to man. There is sufficient evidence to provide a strong presumption that human exposure to a substance may result in the development of cancer. Generally on the basis of: - appropriate long-term animal studies - other relevant information.
Mutagen Category 1:	Substances known to be mutagenic to man. There is sufficient evidence to establish a causal association between human exposure to a substance and heritable genetic damage.
Mutagen Category 2:	Substances which should be regarded as if they are mutagenic to man. There is sufficient evidence to provide a strong presumption that human exposure to the substance may result in the development of heritable genetic damage, generally on the basis of: - appropriate animal studies, - other relevant information.
Toxic to Reproduction Category 1:	Substances known to impair fertility in humans. There is sufficient evidence to establish a causal relationship between human exposure to the substance and impaired fertility. Substances known to cause developmental toxicity in humans. There is sufficient evidence to establish a causal relationship between human exposure to the substance and subsequent developmental toxic effects in the progeny.
Toxic to Reproduction Category 2:	Substances which should be regarded as if they impair fertility in humans. There is sufficient evidence to provide a strong presumption that human exposure to the substance may result in impaired fertility on the basis of: - clear evidence in animal studies of impaired fertility in the absence of toxic effects, or, evidence of impaired fertility occurring at around the same dose levels as other toxic effects but which is not a secondary nonspecific consequence of the other toxic effects, - other relevant information. Substances which should be regarded as if they cause developmental toxicity to humans. There is sufficient evidence to provide a strong presumption that human exposure to the substance may result in developmental toxicity, generally on the basis of: - clear results in appropriate animal studies where effects have been observed in the absence of signs of marked maternal toxicity, or at around the same dose levels as other toxic effects but which are not a secondary non-specific consequence of the other toxic effects, - other relevant information.
PBT & vPvB:	Substances which are persistent, bioaccumulative and toxic (PBT) or very persistent and very bioaccumulative (vPvB) pose a particular challenge to the chemicals safety management. For these substances a "safe" concentration in the environment cannot be established with sufficient reliability.

Unless otherwise stated the results shown in this test report refer only to the sample(s) tested. This test report cannot be reproduced, except in full, without prior written permission of the Company.
除非另有說明，此報告結果僅對測試之樣品負責。本報告未經本公司書面許可，不可部分複製。
This Test Report is issued by the Company under its General Conditions of Service printed overleaf or available on request and accessible at http://www.sgs.com/terms_and_conditions.htm. Attention is drawn to the limitation of liability, indemnification and jurisdiction issues defined therein. Any holder of this Test Report is advised that information contained hereon reflects the Company's findings at the time of its intervention only and within the limits of Client's instructions, if any. The Company's sole responsibility is to its Client and this document does not exonerate parties to a transaction from exercising all their rights and obligations under the transaction documents. Any unauthorized alteration, forgery or falsification of the content or appearance of this document is unlawful and offenders may be prosecuted to the fullest extent of the law.

SGS Taiwan Ltd.
台灣檢驗科技股份有限公司 | Chemical-Taipei 33 WuChyuan Road, Wuku Industrial Zone, Taipei County, Taiwan / 台北縣五股工業區五權路33號 | + 886 (02)2299 3279 f + 886 (02)2299 3237 www.sgs.com

Member of the SGS Group (SGS SA)





**Test Report
(SVHC)**

No. : CR/2009/B0181 Date : 2009/11/27 Page : 7 of 8

FOX ELECTRONICS
5570 ENTERPRISE PARKWAY FT. MYERS, FL 33905, USA



【Appendix B】

SVHC SURVEY FORM			
Company Name	FOX ELECTRONICS		
Product name	XPRESSO CLOCK OSCILLATORS		
Product/Sampling weight	0.2 g		
Report No.	CR/2009/B0181		
Substance identification			
Substance name	Concentration of Article (%)	weight (mg)	providing information about safe use according to Article 33 is necessary
Anthracene	n.d.	N/A	No
4,4' - Diaminodiphenylmethane	n.d.	N/A	No
DBP (Dibutyl phthalate)	n.d.	N/A	No
BBP (Benzyl butyl phthalate)	n.d.	N/A	No
DEHP (Di- (2-ethylhexyl) phthalate)	n.d.	N/A	No
5-tert-butyl-2,4,6-trinitro- m-xylene (Musk Xylene)	n.d.	N/A	No
Hexabromocyclododecane (HBCDD) and all major diastereoisomers identified (α- HBCDD, β- HBCDD, γ- HBCDD)	n.d.	N/A	No
Alkanes, C10-13, chloro (Short Chain Chlorinated Paraffins)	n.d.	N/A	No
Bis(tributyltin)oxide	n.d.	N/A	No
Cobalt dichloride	n.d.	N/A	No
Diarsenic pentaoxide	n.d.	N/A	No
Diarsenic trioxide	n.d.	N/A	No
Triethyl arsenate	n.d.	N/A	No
Lead hydrogen arsenate	n.d.	N/A	No
Sodium dichromate	n.d.	N/A	No

Note: N/A = Non-Available

Unless otherwise stated the results shown in this test report refer only to the sample(s) tested. This test report cannot be reproduced, except in full, without prior written permission of the Company.
 除非另有說明，此報告結果僅對測試之樣品負責。本報告未經本公司書面許可，不可部分複製。
 This Test Report is issued by the Company under its General Conditions of Service printed overleaf or available on request and accessible at http://www.sgs.com/terms_and_conditions.htm. Attention is drawn to the limitation of liability, indemnification and jurisdiction issues defined therein. Any holder of this Test Report is advised that information contained hereon reflects the Company's findings at the time of its intervention only and within the limits of Client's instructions, if any. The Company's sole responsibility is to its Client and this document does not exonerate parties to a transaction from exercising all their rights and obligations under the transaction documents. Any unauthorized alteration, forgery or falsification of the content or appearance of this document is unlawful and offenders may be prosecuted to the fullest extent of the law.

SGS Taiwan Ltd.
 台灣檢驗科技股份有限公司 | Chemical-Taipei 33 WuChyuan Road, Wuku Industrial Zone, Taipei County, Taiwan / 台北縣五股工業區五權路33號 t + 886 (02)2299 3279 f + 886 (02)2299 3237 www.sgs.com

Member of the SGS Group (SGS SA)





Test Report (SVHC)

No. : CR/2009/B0181 Date : 2009/11/27 Page : 8 of 8

FOX ELECTRONICS
5570 ENTERPRISE PARKWAY FT. MYERS, FL 33905, USA



【Appendix C】

Tested Unit No.1 : OSCILLATORS (Weight: 0.2g)

Substance Name	Concentration (%)	RL	Sample picture
Anthracene	n.d.	0.005	
4,4' - Diaminodiphenylmethane	n.d.	0.005	
DBP (Dibutyl phthalate)	n.d.	0.005	
BBP (Benzyl butyl phthalate)	n.d.	0.005	
DEHP (Di- (2-ethylhexyl) phthalate)	n.d.	0.005	
5-tert-butyl-2,4,6-trinitro- m-xylene (Musk Xylene)	n.d.	0.005	
Hexabromocyclododecane (HBCDD) and all major diastereoisomers identified (α- HBCDD, β- HBCDD, γ- HBCDD)	n.d.	0.005	
Alkanes, C10-13, chloro (Short Chain Chlorinated Paraffins)	n.d.	0.01	
Tributyl Tin (TBT)	n.d.	0.005	
Bis(tributyltin)oxide	n.d.	-	
Cobalt dichloride	n.d.	0.05	
Arsenic (As)	n.d.	0.005	
Diarsenic pentaoxide	n.d.	-	
Diarsenic trioxide	n.d.	-	
Triethyl arsenate	n.d.	-	
Lead (Pb)	n.d.	0.005	
Lead hydrogen arsenate	n.d.	-	
Hexavalent Chromium Cr(VI)	n.d.	0.005	
Sodium dichromate	n.d.	-	
Cyclododecane	n.d.	0.005	

Note:

- The average concentration of a whole article can be calculated per the following formula.

$$C_{Average\ of\ Article} = \frac{\sum_{i=1}^n (C_i * W_i)}{\sum_{i=1}^n (W_i)}$$

C_i : Concentration of a SVHC item in each tested unit

W_i : Weight of each tested unit

$C_{Average\ of\ Article}$: Average concentration of a whole article

**** End of Report ****

Unless otherwise stated the results shown in this test report refer only to the sample(s) tested. This test report cannot be reproduced, except in full, without prior written permission of the Company. 除非另有說明，此報告結果僅對測試之樣品負責。本報告未經本公司書面許可，不可部分複製。
This Test Report is issued by the Company under its General Conditions of Service printed overleaf or available on request and accessible at http://www.sgs.com/terms_and_conditions.htm. Attention is drawn to the limitation of liability, indemnification and jurisdiction issues defined therein. Any holder of this Test Report is advised that information contained hereon reflects the Company's findings at the time of its intervention only and within the limits of Client's instructions, if any. The Company's sole responsibility is to its Client and this document does not exonerate parties to a transaction from exercising all their rights and obligations under the transaction documents. Any unauthorized alteration, forgery or falsification of the content or appearance of this document is unlawful and offenders may be prosecuted to the fullest extent of the law.

SGS Taiwan Ltd. 台灣檢驗科技股份有限公司 | Chemical-Taipei 33 WuChyuan Road, Wuku Industrial Zone, Taipei County, Taiwan / 台北縣五股工業區五權路33號 | + 886 (02)2299 3279 F + 886 (02)2299 3237 www.sgs.com

Member of the SGS Group (SGS SA)



Mechanical Testing

Parameter	Test Method
Mechanical Shock	Drop from 75cm to hardwood surface – 3 times
Mechanical Vibration	10~55Hz, 1.5mm amplitude, 1 Minute Sweep 2 Hours each in 3 Directions (X, Y, Z)
High Temperature Burn-in	Under Power @ 125°C for 2000 Hours (results below)
Hermetic Seal	He pressure: $4 \pm 1 \text{ kgf / cm}^2$ 2 Hour soak

2,000 Hour Burn-In

Burn-In Testing – under power 2000 Hours, 125°C

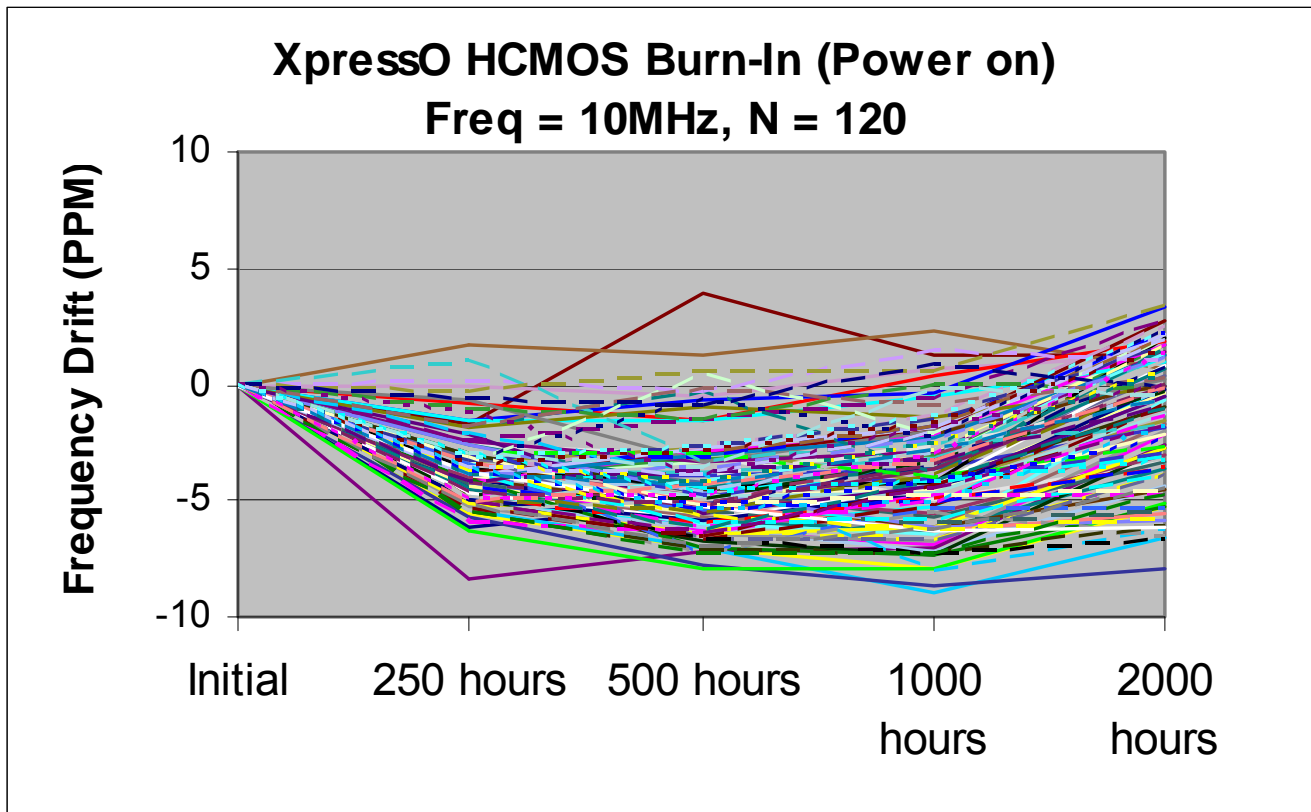

MTTF / FITS Calculations

Products are grouped together by process for MTTF calculations.
 (All XpressO output and package types are manufactured with the same process)

Number of Parts Tested: 360 (120 of each output type: HCMOS, LVDS, LVPECL)
Number of Failures: 0
Test Temperature: 125°C
Number of Hours: 2000

MTTF was calculated using the following formulas:

[1.] Device Hours (*devhrs*) = (number of devices) x (hours at elevated temperature in °K)

$$[2.] MTTF = \frac{devhrs \times af \times 2}{\chi^2}$$

$$[3.] FITS = \frac{1}{MTTF} * 10^9$$

Where:

Label	Name	Formula/Value
<i>af</i>	Acceleration Factor	$e^{\left(\frac{eV}{k}\right) \times \left(\frac{1}{t_1} - \frac{1}{t_2}\right)}$
<i>eV</i>	Activation Energy	0.40 V
<i>k</i>	Bolzman's Constant	8.62 X 10 ⁻⁵ eV/°K
<i>t₁</i>		Operating Temperature (°K)
<i>t₂</i>		Accelerated Temperature (°K)
Θ	Theta	Confidence Level (60% industry standard)
<i>r</i>	Failures	Number of failed devices
χ^2	Chi-Square	statistical significance for bivariate tabular analysis [table look-up] based on assumed Θ (Theta – confidence) and number of failures (<i>r</i>) For zero failures (60% Confidence): $\chi^2 = 1.830$

$$DEVICE-HOURS = 360 \times 2000 \text{ HOURS} = 720,000$$

$$ACCELERATION FACTOR = e^{\left(\frac{0.40}{8.625}\right) \times \left(\frac{1}{298} - \frac{1}{398}\right)} = 49.91009$$

$$MTTF = \frac{720,000 \times 49.91009 \times 2}{1.833} = 39,209,238 \text{ Hours}$$

$$\text{Failure Rate} = \frac{1.833}{720,000 \times 49.91009 \times 2} = 2.55E-8$$

$$FITS = \text{Failure Rate} * 1E9 = 26$$

Notes :

Other XPRESSO Links

[XPRESSO Brochure](#)

Crystal Oscillators
HCMOS 5 x 3.2mm 3.3V XO 0.75 to 250MHz
HCMOS 7 x 5mm 3.3V XO 0.75 to 250MHz
LVPECL 5 x 3.2mm 3.3V XO 0.75 to 1.35GHz
LVPECL 7 x 5mm 3.3V XO 0.75 to 1.35GHz
LVDS 5 x 3.2mm 3.3V XO 0.75 to 1.35GHz
LVDS 7 x 5mm 3.3V XO 0.75 to 1.35GHz
Voltage Controlled Crystal Oscillators
HCMOS 5 x 3.2mm 3.3V VCXO 0.75 to 250MHz
HCMOS 7 x 5mm 3.3V VCXO 0.75 to 250MHz
LVPECL 5 x 3.2mm 3.3V VCXO 0.75 to 1.35GHz
LVPECL 7 x 5mm 3.3V VCXO 0.75 to 1.35GHz
LVDS 5 x 3.2mm 3.3V VCXO 0.75 to 1.35GHz
LVDS 7 x 5mm 3.3V VCXO 0.75 to 1.35GHz

[Main Website www.foxonline.com](http://www.foxonline.com)

Patent Numbers:
 US 6,664,860, US 5,960,403, US 5,952,890; US 5,960,405; US 6,188,290;
 Foreign Patents: R.S.A. 98/0866, R.O.C. 120851; Singapore 67081, 67082; EP 0958652
 China ZL 98802217.6, Malaysia MY-118540-A, Philippines 1-1998-000245, Hong Kong #HK1026079, Mexico #232179
 US and Foreign Patents Pending
 XpressO™ Fox Electronics

Contact Information

(USA)-Worldwide Headquarters

Tel: 888-GET-2-FOX
 Outside US: +1.239.693.0099,
 Fax: +1.239.693.1554
 Email: www.foxonline.com/email.htm

Fox Hong Kong

Tel: +852.2854.4285,
 Fax: +852.2854.4282
 Email: www.foxonline.com/email.htm

Fox EMEA

Tel/Fax: +44.1767.312632
 Email: www.foxonline.com/email.htm

Fox Japan

Tel: +81.3.3374.2079,
 Fax: +81.3.3377.5221
 Email: www.foxonline.com/email.htm

The above specifications, having been carefully prepared and checked, is believed to be accurate at the time of publication; however, no responsibility is assumed by Fox Electronics for inaccuracies.

