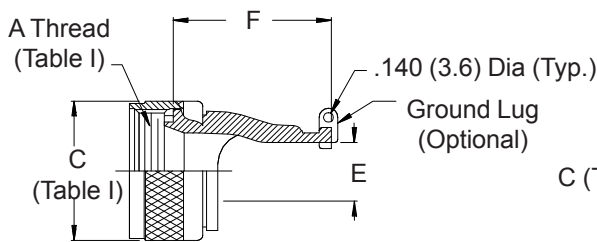
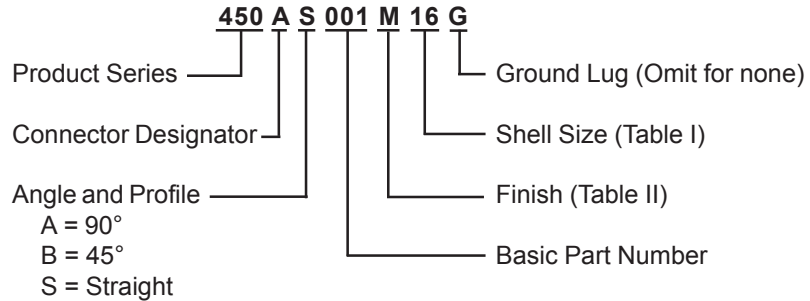
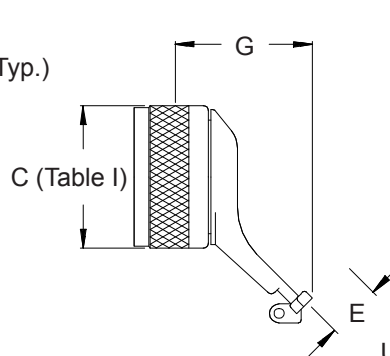
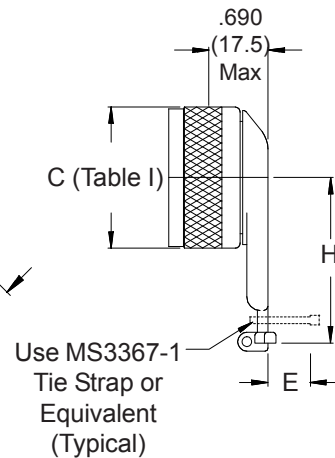

**CONNECTOR
DESIGNATOR**
A

**STRAIGHT
ROTATABLE COUPLING**

**45°
ROTATABLE COUPLING**

**90°
ROTATABLE COUPLING**

See inside back cover fold-out or pages 13 and 14 for Tables I and II.

TABLE III: DIMENSIONS

Shell Size	E Cable Entry	F Max	G Max	H Max
08	.260 (6.6)	.866 (22.0)	1.066 (27.1)	.890 (22.6)
10	.365 (9.3)	.866 (22.0)	1.066 (27.1)	.950 (24.1)
12	.501 (12.7)	.926 (23.5)	1.066 (27.1)	1.010 (25.7)
14	.575 (14.6)	1.106 (28.1)	1.188 (30.2)	1.330 (33.8)
16	.700 (17.8)	1.106 (28.1)	1.226 (31.1)	1.390 (35.3)
18	.779 (19.8)	1.176 (29.9)	1.226 (31.1)	1.460 (37.1)
20	.904 (23.0)	1.306 (33.2)	1.226 (31.1)	1.510 (38.4)
22	1.029 (26.1)	1.426 (36.2)	1.226 (31.1)	1.570 (39.9)
24	1.144 (29.1)	1.556 (39.5)	1.226 (31.1)	1.640 (41.7)

1. Cable Entry is defined as the accommodation entry for the wire bundle or cable. Dimensions are not intended for inspection criteria.
2. Metric dimensions (mm) are indicated in parentheses.