

MIL-C-5015

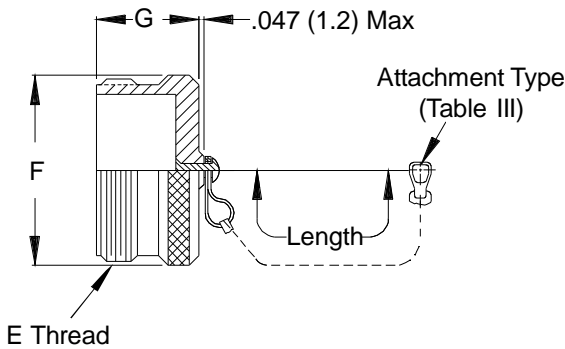

660-004 Plug Cover

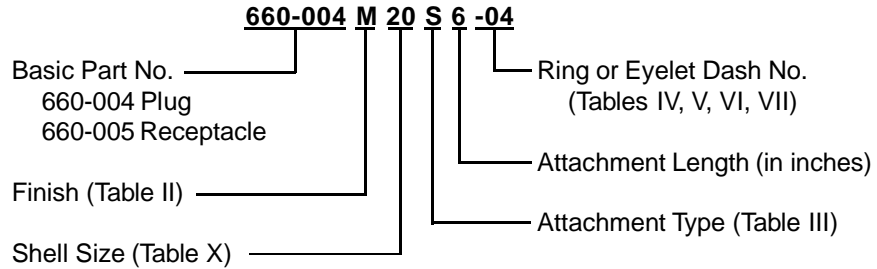
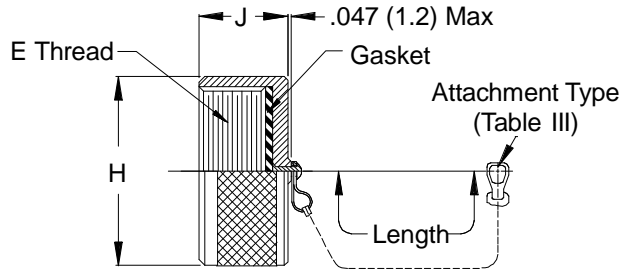

660-005 Receptacle Cover

TABLE X: SHELL SIZE DIMENSIONS

Shell Size	E Thread	F Max	G Max	H Max	J Max
08	1/2 - 28 UNEF	.562 (14.3)	.656 (16.7)	.688 (17.5)	.465 (11.8)
10	5/8 - 24 UNEF	.687 (17.4)	.656 (16.7)	.815 (20.7)	.465 (11.8)
12	3/4 - 20 UNEF	.812 (20.6)	.844 (21.4)	1.000 (25.4)	.465 (11.8)
14	7/8 - 20 UNEF	.937 (23.8)	.844 (21.4)	1.125 (28.6)	.465 (11.8)
16	1 - 20 UNEF	1.062 (27.0)	.844 (21.4)	1.188 (30.2)	.465 (11.8)
18	1 1/8 - 18 UNEF	1.187 (30.1)	.844 (21.4)	1.344 (34.1)	.465 (11.8)
20	1 1/4 - 18 UNEF	1.312 (33.3)	.844 (21.4)	1.469 (37.3)	.465 (11.8)
22	1 3/8 - 18 UNEF	1.437 (36.5)	.844 (21.4)	1.594 (40.5)	.465 (11.8)
24	1 1/2 - 18 UNEF	1.562 (39.7)	.844 (21.4)	1.719 (43.7)	.465 (11.8)
28	1 3/4 - 18 UNS	1.812 (46.0)	.844 (21.4)	1.969 (50.0)	.531 (13.5)
32	2 - 18 UNS	2.062 (52.4)	.844 (21.4)	2.219 (56.4)	.531 (13.5)
36	2 1/4 - 16 UN	2.312 (58.7)	.844 (21.4)	2.469 (62.7)	.531 (13.5)
40	2 1/2 - 16 UN	2.562 (65.1)	.844 (21.4)	2.719 (69.1)	.531 (13.5)
44	2 3/4 - 16 UN	2.812 (71.4)	.844 (21.4)	2.969 (75.4)	.531 (13.5)
48	3 - 16 UN	3.062 (77.8)	.844 (21.4)	3.188 (81.0)	.531 (13.5)

See inside back cover fold-out or page 14 for Table II.

Metric dimensions (mm) are indicated in parentheses.

660-004 (Plug) - 660-005 (Receptacle)
Protective Covers
MIL-C-5015



66 & 78

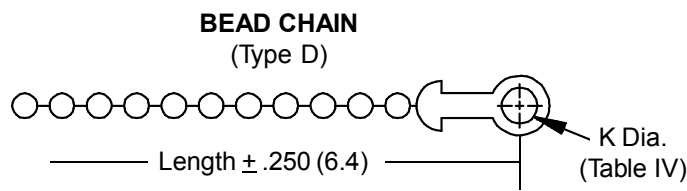
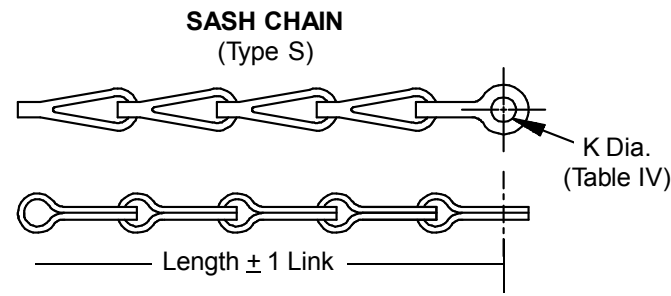
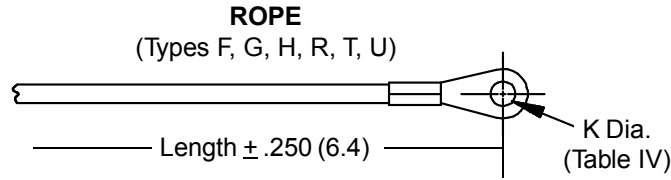

TABLE III: ATTACHMENT

Sym	Attachment Type
D	Bead Chain, Cres., Passivate
F	Wire Rope, Nylon Jacket
G	Nylon Rope
H	Wire Rope, Fluoropolymer Jacket
N	No Attachment
R	Wire Rope, PVC Jacket
S	#8 Sash Chain, Cres., Passivate
T	Wire Rope, No Jacket
U	Wire Rope, Polyurethane Jacket with Terminal

TABLE IV: EYELET

Dash No.	K DIA	±.010 (0.3)
01	.140 (3.6)	
02	.182 (4.6)	
03	.191 (4.9)	
04	.197 (5.0)	
05	.167 (4.2)	
06	.125 (3.2)	
07	.218 (5.5)	
09	.156 (4.0)	
00	No Eyelet	

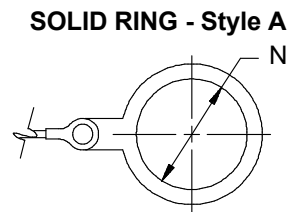
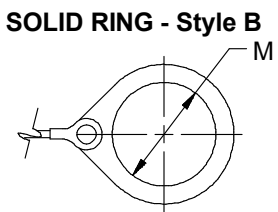
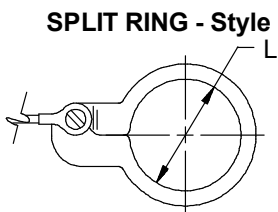

TABLE V: SPLIT RING STYLE C

Dash No.	L Dia. ±.015 (0.4)	Dash No.	L Dia. ±.015 (0.4)
50	.425 (10.8)	74	1.625 (41.3)
52	.485 (12.3)	76	1.750 (44.5)
54	.640 (16.3)	78	1.875 (47.6)
56	.750 (19.1)	80	1.980 (50.3)
58	.890 (22.6)	82	2.060 (52.3)
60	1.015 (25.8)	84	2.235 (56.8)
62	1.095 (27.8)	86	2.310 (58.7)
64	1.130 (28.7)	88	2.475 (62.9)
66	1.250 (31.8)	90	2.655 (67.4)
68	1.350 (34.3)	92	2.810 (71.4)
70	1.390 (35.3)	94	3.045 (77.3)
72	1.485 (37.7)		

TABLE VI: SOLID RING STYLE B

Dash No.	M Dia. ±.015 (0.4)	Dash No.	M Dia. ±.015 (0.4)
08	.468 (11.9)	24	1.484 (37.7)
10	.593 (15.1)	25	1.577 (40.1)
12	.718 (18.2)	27	1.640 (41.7)
13	.765 (19.4)	28	1.687 (42.8)
14	.844 (21.4)	29	1.765 (44.8)
15	.890 (22.6)	30	1.890 (48.0)
16	.968 (24.6)	31	1.953 (49.6)
17	1.015 (25.8)	32	1.968 (50.0)
18	1.093 (27.8)	33	2.077 (52.8)
19	1.140 (29.0)	35	2.140 (54.4)
20	1.203 (30.6)	36	2.187 (55.5)
21	1.265 (32.1)	40	2.406 (61.1)
22	1.343 (34.1)	44	2.656 (67.5)
23	1.453 (36.9)	48	3.031 (77.0)
		118	.310 (7.9)

TABLE VII: SOLID RING STYLE A

Dash No.	N Dia. ±.015 (0.4)	Dash No.	N Dia. ±.015 (0.4)
095	.312 (7.9)	109	1.266 (32.2)
100	.391 (9.9)	209	1.312 (33.3)
101	.516 (13.1)	110	1.391 (35.3)
102	.583 (14.8)	210	1.438 (36.5)
103	.641 (16.3)	111	1.521 (38.6)
104	.708 (18.0)	211	1.536 (39.0)
105	.766 (19.5)	112	1.641 (41.7)
205	.788 (20.0)	113	1.766 (44.9)
106	.896 (22.2)	213	1.812 (46.0)
206	.907 (23.0)	114	1.891 (48.0)
107	1.016 (25.8)	214	1.938 (49.2)
207	1.025 (26.0)	115	2.078 (52.8)
108	1.141 (29.0)	116	2.406 (61.1)
308	1.188 (30.2)	117	2.510 (63.8)
208	1.203 (30.6)		