

AS85049/42 and MS3057D
 Straight Non-Self-Locking Strain Relief
 for Use with MS "V" Thread General Duty "A" End Bell



AS85049



Superseded Part Number

MS3057 -10D A

Basic Part No. | Dash No. | Metal and Finish Designator

A = Aluminum Cadmium Olive Drab over Electroless Nickel
 C = Aluminum, Cadmium Olive Drab
 N = Aluminum, Electroless Nickel
 D = 300 Series Steel, Cadmium Black Plate
 S = 300 Series Steel, Passivate

Material/Finish

N = Aluminum/Electroless Nickel
W = Aluminum/1,000 Hour Cadmium over Electroless Nickel
X = Aluminum/Nickel Fluorocarbon Polymer
Y = Aluminum/Pure Dense Electrodeposited Aluminum
Z = Aluminum/Zinc Nickel Black
B = Stainless Steel/Cadmium Black
S = Stainless Steel/Passivated
XS = Stainless Steel/Nickel Fluorocarbon Polymer
YS = Stainless Steel/Pure Dense Electrodeposited Aluminum
ZS = Stainless Steel/Zinc Nickel Black

B

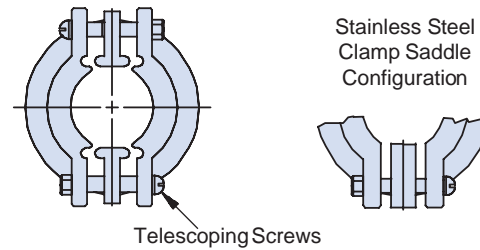
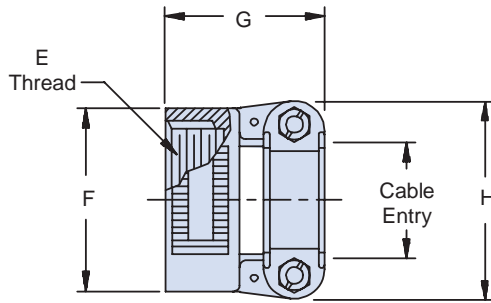

TABLE I: Shell Size, Cable Entry and Backshell Dimensions

Dash No.	E Thread Class 2B	Ø F Max	Ø G		H		Cable Entry			
			±.020	(.5)	±.020	(.5)	Max		Min	
4D	5/8 - 24 UNEF	.937 (23.8)	1.281 (32.5)	1.281 (32.5)	.937 (23.8)	.312 (7.9)	.125 (3.2)	.250 (6.4)	.125 (3.2)	.125 (3.2)
6D	3/4 - 20 UNEF	1.031 (26.2)	1.281 (32.5)	1.281 (32.5)	1.125 (28.6)	.437 (11.1)	.250 (6.4)	.250 (6.4)	.250 (6.4)	.250 (6.4)
8D	7/8 - 20 UNEF	1.250 (31.8)	1.281 (32.5)	1.281 (32.5)	1.312 (33.3)	.562 (14.3)	.312 (7.9)	.312 (7.9)	.312 (7.9)	.312 (7.9)
10D	1 - 20 UNEF	1.250 (31.8)	1.281 (32.5)	1.281 (32.5)	1.312 (33.3)	.625 (15.9)	.350 (8.9)	.350 (8.9)	.350 (8.9)	.350 (8.9)
12D	1 3/16 - 18 UNEF	1.437 (36.5)	1.312 (33.3)	1.312 (33.3)	1.531 (38.9)	.750 (19.1)	.500 (12.7)	.500 (12.7)	.500 (12.7)	.500 (12.7)
16D	1 7/16 - 18 UNEF	1.688 (42.9)	1.406 (35.7)	1.406 (35.7)	1.750 (44.5)	.937 (23.8)	.625 (15.9)	.625 (15.9)	.625 (15.9)	.625 (15.9)
20D	1 3/4 - 18 UNS	2.000 (50.8)	1.563 (39.7)	1.563 (39.7)	2.093 (53.2)	1.250 (31.8)	.875 (22.2)	.875 (22.2)	.875 (22.2)	.875 (22.2)
24D	2 - 18 UNS	2.250 (57.2)	1.625 (41.3)	1.625 (41.3)	2.343 (59.5)	1.375 (34.9)	1.000 (25.4)	1.000 (25.4)	1.000 (25.4)	1.000 (25.4)
28D	2 1/4 - 16 UN	2.500 (63.5)	1.900 (48.3)	1.900 (48.3)	2.750 (69.9)	1.625 (41.3)	1.250 (31.8)	1.250 (31.8)	1.250 (31.8)	1.250 (31.8)
32D	2 1/2 - 16 UN	2.750 (69.9)	1.900 (48.3)	1.900 (48.3)	3.000 (76.2)	1.875 (47.6)	1.437 (36.5)	1.437 (36.5)	1.437 (36.5)	1.437 (36.5)

- APPLICATION NOTES**
1. Assembly to be identified with manufacturer's name and part number, space permitting.
 2. Cable Entry is defined as the accommodation entry for the wire bundle or cable. Dimensions are not intended for inspection criteria.
 3. For complete dimensions, see the applicable Military Specification.
 4. Metric dimensions (mm) are in parentheses.

Dimensions in inches (millimeters) and are subject to change without notice.