

**CONNECTOR
 DESIGNATORS
 A-F-H-L-S
 ROTATABLE
 COUPLING**

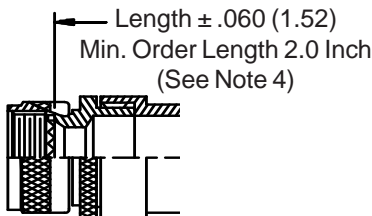

**STYLE 2
 (STRAIGHT
 See Note 1)**

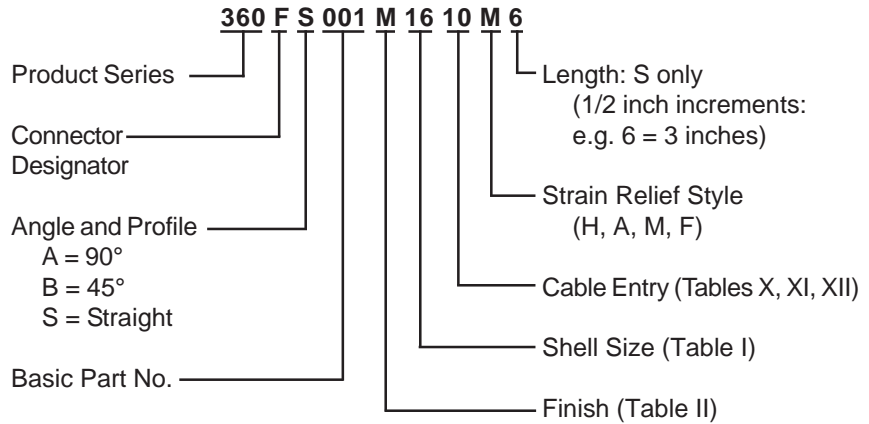
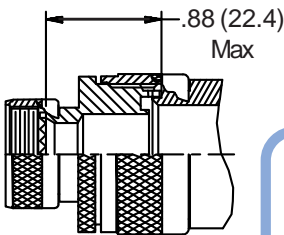

**STYLE 2
 (45° - 90°
 See Note 1)**

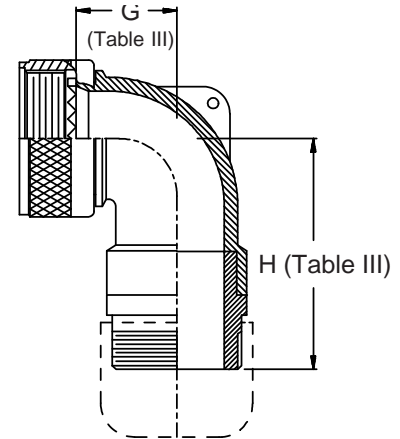
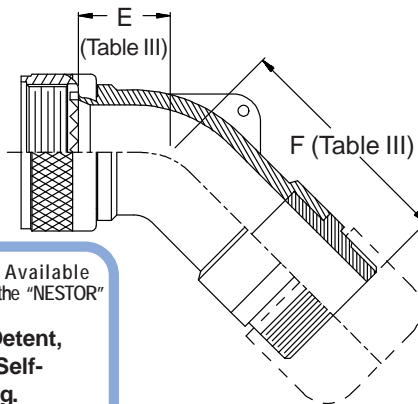
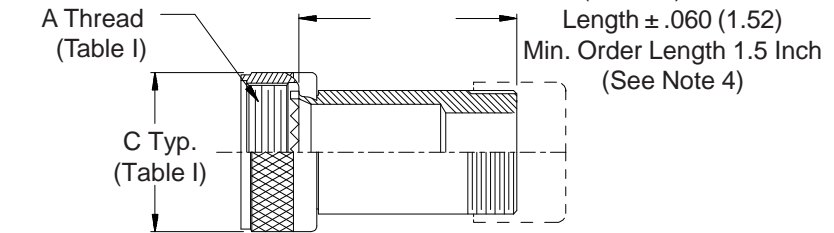

-445 Now Available with the "NESTOR"
 Glenair's Non-Detent, Spring-Loaded, Self-Locking Coupling.
 Add "-445" to Specify This AS85049 Style "N" Coupling Interface.

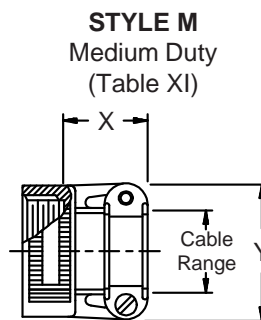
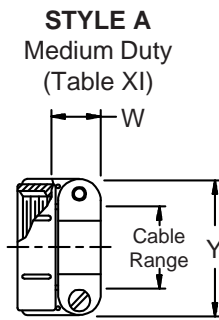

360-001
Non-Environmental Backshell
with Strain Relief
Low Profile - Rotatable Coupling



TABLE III: DIMENSIONS

| Shell Size | | E Max | F Max | G Max | H Max |
|-------------------------|----|--------------|--------------|--------------|--------------|
| Conn. Desig. A-F-L-S | H | | | | |
| 08 | 09 | .457 (11.6) | 1.622 (41.2) | .500 (12.7) | 1.632 (41.5) |
| 10 | 11 | .520 (13.2) | 1.682 (42.7) | .595 (15.1) | 1.752 (44.5) |
| 12 | 13 | .582 (14.8) | 1.742 (44.2) | .610 (15.5) | 1.772 (45.0) |
| 14 | 15 | .645 (16.4) | 2.062 (52.4) | .700 (17.8) | 2.072 (52.6) |
| 16 | 17 | .738 (18.7) | 2.172 (55.2) | .885 (22.5) | 2.162 (54.9) |
| 18 | 19 | .926 (23.5) | 2.362 (60.0) | .975 (24.8) | 2.332 (59.2) |
| 20 | 21 | .926 (23.5) | 2.362 (60.0) | .975 (24.8) | 2.332 (59.2) |
| 22 | 23 | 1.020 (25.9) | 2.512 (63.8) | 1.125 (28.6) | 2.442 (62.0) |
| 24 | 25 | 1.020 (25.9) | 2.512 (63.8) | 1.125 (28.6) | 2.442 (62.0) |
| 28 | | 1.145 (29.1) | 2.562 (65.1) | 1.225 (31.1) | 2.612 (66.3) |
| 32 | | 1.207 (30.7) | 2.662 (67.6) | 1.575 (40.0) | 2.862 (72.7) |
| 36 | | 1.238 (31.4) | 2.752 (69.9) | 1.775 (45.1) | 2.862 (72.7) |

TABLE II: STANDARD FINISHES

| GLENAIR SYMBOL | FINISH |
|---|---|
| B | Cadmium Plate, Olive Drab |
| C | Anodize, Black |
| G | Hard Coat, Anodic |
| M | Electroless Nickel |
| NF | Cadmium Plate, Olive Drab Over Electroless Nickel |
| See Inside Back Cover for Additional Finish Options | |

See inside back cover
fold-out or pages 13
and 14 for unabridged
Tables I and II.

TABLE X: CABLE ENTRY

| Dash No. | T Max | V Max | Cable Range | | | |
|----------|--------------|--------------|--------------|--------------|--------------|--------------|
| | | | Min | Max | Min | Max |
| 04 | .780 (19.8) | .957 (24.3) | .125 (3.2) | .312 (7.9) | .125 (3.2) | .312 (7.9) |
| 06 | .780 (19.8) | 1.145 (29.1) | .250 (6.4) | .437 (11.1) | .250 (6.4) | .437 (11.1) |
| 08 | .780 (19.8) | 1.332 (33.8) | .312 (7.9) | .562 (14.3) | .312 (7.9) | .562 (14.3) |
| 10 | .780 (19.8) | 1.332 (33.8) | .350 (8.9) | .625 (15.9) | .350 (8.9) | .625 (15.9) |
| 12 | .811 (20.6) | 1.551 (39.4) | .500 (12.7) | .750 (19.1) | .500 (12.7) | .750 (19.1) |
| 16 | .905 (23.0) | 1.770 (45.0) | .625 (15.9) | .937 (23.8) | .625 (15.9) | .937 (23.8) |
| 20 | 1.092 (27.7) | 2.113 (53.7) | .875 (22.2) | 1.250 (31.8) | .875 (22.2) | 1.250 (31.8) |
| 24 | 1.124 (28.5) | 2.363 (60.0) | 1.000 (25.4) | 1.375 (34.9) | 1.000 (25.4) | 1.375 (34.9) |
| 28 | 1.399 (35.5) | 2.770 (70.4) | 1.250 (31.8) | 1.625 (41.3) | 1.250 (31.8) | 1.625 (41.3) |
| 32 | 1.399 (35.5) | 3.020 (76.7) | 1.437 (36.5) | 1.875 (47.6) | 1.437 (36.5) | 1.875 (47.6) |

TABLE XII: CABLE ENTRY

| Dash No. | Z Max | Cable Range | | | |
|----------|--------------|--------------|--------------|--------------|--------------|
| | | Min | Max | Min | Max |
| 02 | .968 (24.6) | .125 (3.2) | .250 (6.4) | .125 (3.2) | .250 (6.4) |
| 03 | 1.046 (26.6) | .250 (6.4) | .375 (9.5) | .250 (6.4) | .375 (9.5) |
| 04 | 1.156 (29.4) | .312 (7.9) | .500 (12.7) | .312 (7.9) | .500 (12.7) |
| 05 | 1.218 (30.9) | .437 (11.1) | .625 (15.9) | .437 (11.1) | .625 (15.9) |
| 06 | 1.343 (34.1) | .562 (14.3) | .750 (19.1) | .562 (14.3) | .750 (19.1) |
| 07 | 1.468 (37.3) | .687 (17.4) | .875 (22.2) | .687 (17.4) | .875 (22.2) |
| 08 | 1.593 (40.5) | .812 (20.6) | 1.000 (25.4) | .812 (20.6) | 1.000 (25.4) |
| 10 | 1.843 (46.8) | 1.062 (27.0) | 1.250 (31.8) | 1.062 (27.0) | 1.250 (31.8) |

TABLE XI: CABLE ENTRY

| Dash No. | W Max | X Max | Y Max | Cable Range | | | |
|----------|--------------|--------------|--------------|--------------|--------------|--------------|--------------|
| | | | | Min | Max | Min | Max |
| 03* | .437 (11.1) | .760 (19.3) | .843 (21.4) | .156 (4.0) | .250 (6.4) | .156 (4.0) | .250 (6.4) |
| 04* | .437 (11.1) | .760 (19.3) | .906 (23.0) | .188 (4.8) | .312 (7.9) | .188 (4.8) | .312 (7.9) |
| 06* | .500 (12.7) | .760 (19.3) | 1.093 (27.8) | .281 (7.1) | .438 (11.1) | .281 (7.1) | .438 (11.1) |
| 08 | .563 (14.3) | .760 (19.3) | 1.187 (30.1) | .344 (8.7) | .562 (14.3) | .344 (8.7) | .562 (14.3) |
| 10 | .563 (14.3) | .760 (19.3) | 1.281 (32.5) | .375 (9.5) | .625 (15.9) | .375 (9.5) | .625 (15.9) |
| 12 | .563 (14.3) | .760 (19.3) | 1.500 (38.1) | .438 (11.1) | .750 (19.1) | .438 (11.1) | .750 (19.1) |
| 16 | .656 (16.7) | 1.073 (27.3) | 1.719 (43.7) | .562 (14.3) | .938 (23.8) | .562 (14.3) | .938 (23.8) |
| 20 | .656 (16.7) | 1.323 (33.6) | 2.062 (52.4) | .750 (19.1) | 1.250 (31.8) | .750 (19.1) | 1.250 (31.8) |
| 24 | .656 (16.7) | 1.323 (33.6) | 2.312 (58.7) | .781 (19.8) | 1.375 (34.9) | .781 (19.8) | 1.375 (34.9) |
| 28 | 1.188 (30.2) | 1.572 (39.9) | 2.719 (69.1) | .969 (24.6) | 1.625 (41.3) | .969 (24.6) | 1.625 (41.3) |
| 32* | 1.187 (30.1) | 1.572 (39.9) | 2.969 (75.4) | 1.125 (28.6) | 1.875 (47.6) | 1.125 (28.6) | 1.875 (47.6) |
| 40* | 1.125 (28.6) | 1.572 (39.9) | 3.531 (89.7) | 1.469 (37.3) | 2.375 (60.3) | 1.469 (37.3) | 2.375 (60.3) |

* Not available in Style M clamp.

1. When maximum cable entry (page 21) is exceeded, Style 2 will be supplied. Dimensions E, F, G and H will not apply. Please consult factory.
2. Metric dimensions (mm) are indicated in parentheses.
3. Cable range is defined as the accommodations range for the wire bundle or cable. Dimensions shown are not intended for inspection criteria.
4. Consult factory for shorter lengths on straight backshells.