

**CONNECTOR  
 DESIGNATORS  
 A-F-H-L-S  
 ROTATABLE  
 COUPLING**

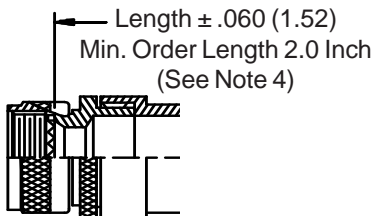

**STYLE 2  
 (STRAIGHT  
 See Note 1)**

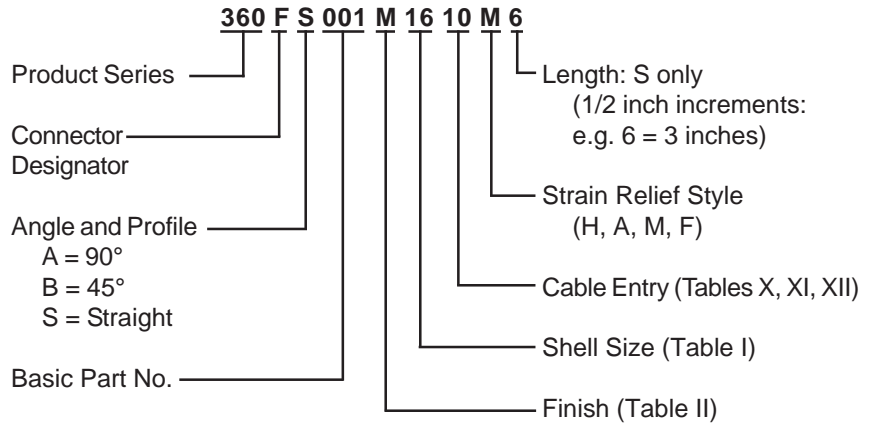
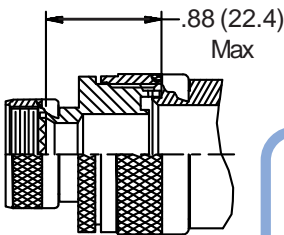

**STYLE 2  
 (45° - 90°  
 See Note 1)**

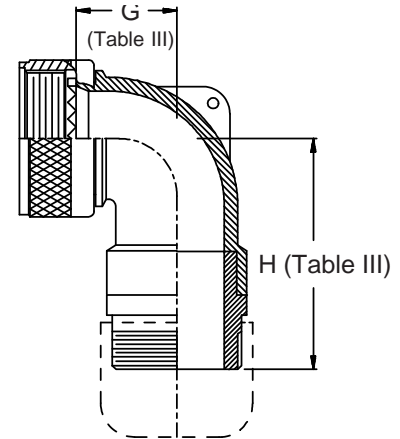
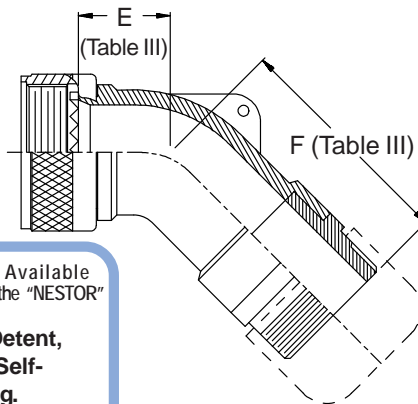
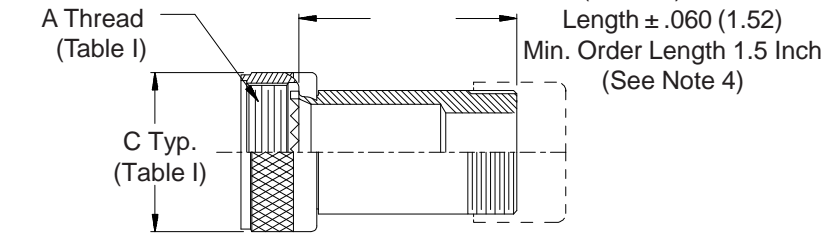

**-445** Now Available with the "NESTOR"  
 Glenair's Non-Detent, Spring-Loaded, Self-Locking Coupling.  
 Add "-445" to Specify This AS85049 Style "N" Coupling Interface.

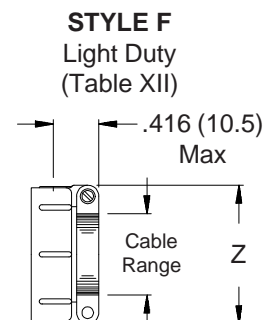
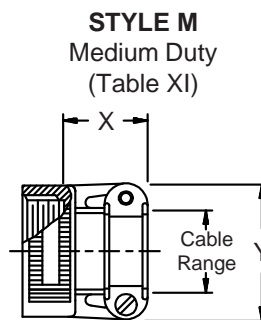
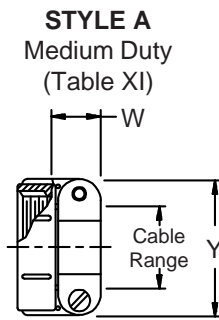
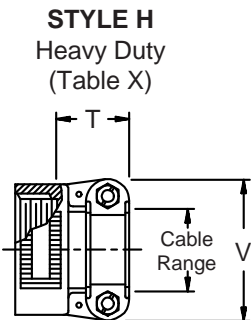

**360-001**  
**Non-Environmental Backshell**  
with Strain Relief  
**Low Profile - Rotatable Coupling**



**TABLE III: DIMENSIONS**

Shell Size Conn. Desig. A-F-L-S H		E Max	F Max	G Max	H Max
08	09	.457 (11.6)	1.622 (41.2)	.500 (12.7)	1.632 (41.5)
10	11	.520 (13.2)	1.682 (42.7)	.595 (15.1)	1.752 (44.5)
12	13	.582 (14.8)	1.742 (44.2)	.610 (15.5)	1.772 (45.0)
14	15	.645 (16.4)	2.062 (52.4)	.700 (17.8)	2.072 (52.6)
16	17	.738 (18.7)	2.172 (55.2)	.885 (22.5)	2.162 (54.9)
18	19	.926 (23.5)	2.362 (60.0)	.975 (24.8)	2.332 (59.2)
20	21	.926 (23.5)	2.362 (60.0)	.975 (24.8)	2.332 (59.2)
22	23	1.020 (25.9)	2.512 (63.8)	1.125 (28.6)	2.442 (62.0)
24	25	1.020 (25.9)	2.512 (63.8)	1.125 (28.6)	2.442 (62.0)
28		1.145 (29.1)	2.562 (65.1)	1.225 (31.1)	2.612 (66.3)
32		1.207 (30.7)	2.662 (67.6)	1.575 (40.0)	2.862 (72.7)
36		1.238 (31.4)	2.752 (69.9)	1.775 (45.1)	2.862 (72.7)

**TABLE II: STANDARD FINISHES**

GLENAIR SYMBOL	FINISH
B	Cadmium Plate, Olive Drab
C	Anodize, Black
G	Hard Coat, Anodic
M	Electroless Nickel
NF	Cadmium Plate, Olive Drab Over Electroless Nickel

See Inside Back Cover for Additional Finish Options

**See inside back cover fold-out or pages 13 and 14 for unabridged Tables I and II.**

**TABLE X: CABLE ENTRY**

Dash No.	T Max	V Max	Cable Range			
			Min	Max	Min	Max
04	.780 (19.8)	.957 (24.3)	.125 (3.2)	.312 (7.9)	.125 (3.2)	.312 (7.9)
06	.780 (19.8)	1.145 (29.1)	.250 (6.4)	.437 (11.1)	.250 (6.4)	.437 (11.1)
08	.780 (19.8)	1.332 (33.8)	.312 (7.9)	.562 (14.3)	.312 (7.9)	.562 (14.3)
10	.780 (19.8)	1.332 (33.8)	.350 (8.9)	.625 (15.9)	.350 (8.9)	.625 (15.9)
12	.811 (20.6)	1.551 (39.4)	.500 (12.7)	.750 (19.1)	.500 (12.7)	.750 (19.1)
16	.905 (23.0)	1.770 (45.0)	.625 (15.9)	.937 (23.8)	.625 (15.9)	.937 (23.8)
20	1.092 (27.7)	2.113 (53.7)	.875 (22.2)	1.250 (31.8)	.875 (22.2)	1.250 (31.8)
24	1.124 (28.5)	2.363 (60.0)	1.000 (25.4)	1.375 (34.9)	1.000 (25.4)	1.375 (34.9)
28	1.399 (35.5)	2.770 (70.4)	1.250 (31.8)	1.625 (41.3)	1.250 (31.8)	1.625 (41.3)
32	1.399 (35.5)	3.020 (76.7)	1.437 (36.5)	1.875 (47.6)	1.437 (36.5)	1.875 (47.6)

**TABLE XII: CABLE ENTRY**

Dash No.	Z Max	Cable Range			
		Min	Max	Min	Max
02	.968 (24.6)	.125 (3.2)	.250 (6.4)	.125 (3.2)	.250 (6.4)
03	1.046 (26.6)	.250 (6.4)	.375 (9.5)	.250 (6.4)	.375 (9.5)
04	1.156 (29.4)	.312 (7.9)	.500 (12.7)	.312 (7.9)	.500 (12.7)
05	1.218 (30.9)	.437 (11.1)	.625 (15.9)	.437 (11.1)	.625 (15.9)
06	1.343 (34.1)	.562 (14.3)	.750 (19.1)	.562 (14.3)	.750 (19.1)
07	1.468 (37.3)	.687 (17.4)	.875 (22.2)	.687 (17.4)	.875 (22.2)
08	1.593 (40.5)	.812 (20.6)	1.000 (25.4)	.812 (20.6)	1.000 (25.4)
10	1.843 (46.8)	1.062 (27.0)	1.250 (31.8)	1.062 (27.0)	1.250 (31.8)

**TABLE XI: CABLE ENTRY**

Dash No.	W Max	X Max	Y Max	Cable Range			
				Min	Max	Min	Max
03*	.437 (11.1)	.760 (19.3)	.843 (21.4)	.156 (4.0)	.250 (6.4)	.156 (4.0)	.250 (6.4)
04*	.437 (11.1)	.760 (19.3)	.906 (23.0)	.188 (4.8)	.312 (7.9)	.188 (4.8)	.312 (7.9)
06*	.500 (12.7)	.760 (19.3)	1.093 (27.8)	.281 (7.1)	.438 (11.1)	.281 (7.1)	.438 (11.1)
08	.563 (14.3)	.760 (19.3)	1.187 (30.1)	.344 (8.7)	.562 (14.3)	.344 (8.7)	.562 (14.3)
10	.563 (14.3)	.760 (19.3)	1.281 (32.5)	.375 (9.5)	.625 (15.9)	.375 (9.5)	.625 (15.9)
12	.563 (14.3)	.760 (19.3)	1.500 (38.1)	.438 (11.1)	.750 (19.1)	.438 (11.1)	.750 (19.1)
16	.656 (16.7)	1.073 (27.3)	1.719 (43.7)	.562 (14.3)	.938 (23.8)	.562 (14.3)	.938 (23.8)
20	.656 (16.7)	1.323 (33.6)	2.062 (52.4)	.750 (19.1)	1.250 (31.8)	.750 (19.1)	1.250 (31.8)
24	.656 (16.7)	1.323 (33.6)	2.312 (58.7)	.781 (19.8)	1.375 (34.9)	.781 (19.8)	1.375 (34.9)
28	1.188 (30.2)	1.572 (39.9)	2.719 (69.1)	.969 (24.6)	1.625 (41.3)	.969 (24.6)	1.625 (41.3)
32*	1.187 (30.1)	1.572 (39.9)	2.969 (75.4)	1.125 (28.6)	1.875 (47.6)	1.125 (28.6)	1.875 (47.6)
40*	1.125 (28.6)	1.572 (39.9)	3.531 (89.7)	1.469 (37.3)	2.375 (60.3)	1.469 (37.3)	2.375 (60.3)

\* Not available in Style M clamp.

1. When maximum cable entry (page 21) is exceeded, Style 2 will be supplied. Dimensions E, F, G and H will not apply. Please consult factory.
2. Metric dimensions (mm) are indicated in parentheses.
3. Cable range is defined as the accommodations range for the wire bundle or cable. Dimensions shown are not intended for inspection criteria.
4. Consult factory for shorter lengths on straight backshells.