

**CONNECTOR DESIGNATORS**  
**A-B\*-C-D-E-F**  
**G-H-J-K-L-S**

\* Conn. Desig. B See Note 5  
**DIRECT COUPLING**

Length ± .060 (1.52)

Min. Order Length 2.0 Inch  
 (See Note 4)

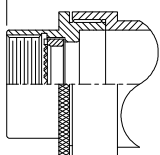

**STYLE 2**  
 (STRAIGHT - See Note 1)

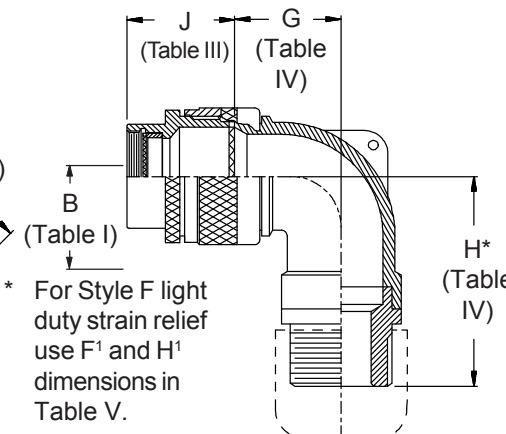
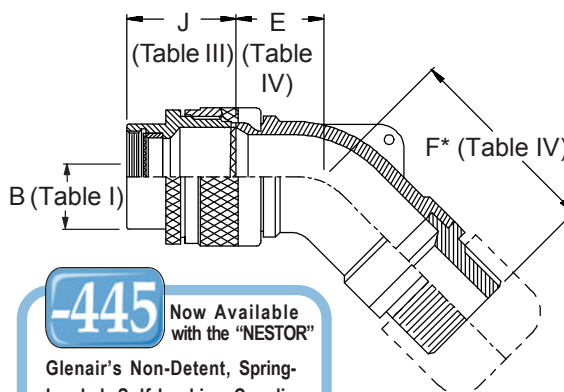
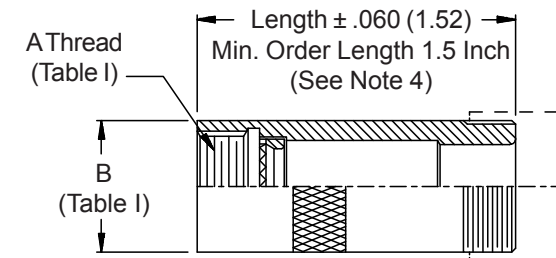
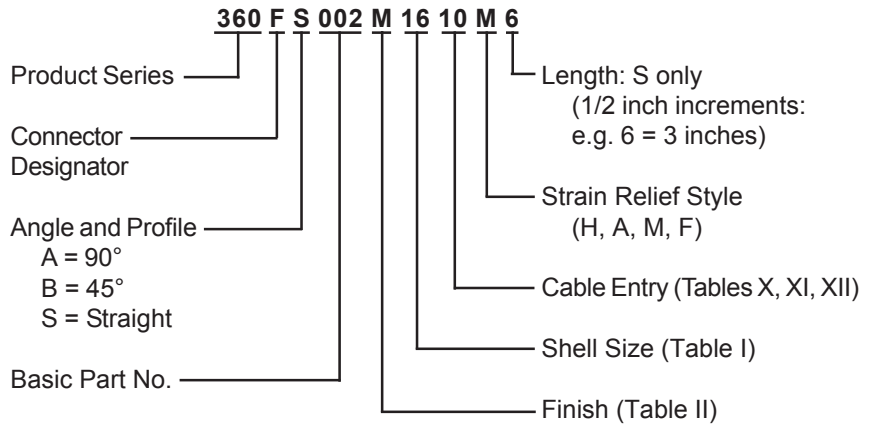

1. When maximum cable entry (page 22) is exceeded, Style 2 will be supplied. (straight only.)
2. Metric dimensions (mm) are indicated in parentheses.
3. Cable range is defined as the accommodations range for the wire bundle or cable. Dimensions shown are not intended for inspection criteria.
4. Consult factory for shorter lengths on straight backshells.
5. When using Connector Designator B refer to pages 18 and 19 for part number development.

**-445** Now Available with the "NESTOR"  
 Glenair's Non-Detent, Spring-Loaded, Self-Locking Coupling. Add "-445" to Specify This AS85049 Style "N" Coupling Interface.

\* For Style F light duty strain relief use F<sup>1</sup> and H<sup>1</sup> dimensions in Table V.

**STYLE H**  
 Heavy Duty  
 (Table X)

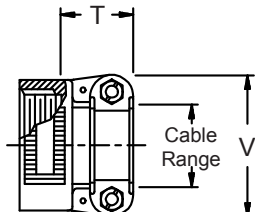

**STYLE A**  
 Medium Duty  
 (Table XI)

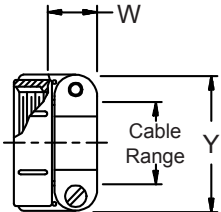

**STYLE M**  
 Medium Duty  
 (Table XI)

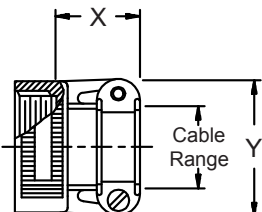

**STYLE F**  
 Light Duty  
 (Table XII)

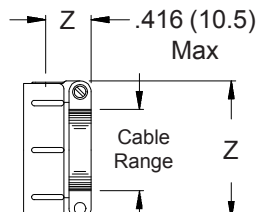

**360-002**  
**Non-Environmental Backshell**  
with Strain Relief  
**Low Profile - Direct Coupling**



**TABLE III: FRONT ADAPTER**

**J Max - Conn. Designator**

Shell Size	A-E-F		
	J-H-L-S	D-B-G-K	C
08/09	1.180 (30.0)	1.440 (36.6)	
10/11	1.180 (30.0)	1.440 (36.6)	
12/13	1.180 (30.0)	1.440 (36.6)	1.735 (44.1)
14/15	1.180 (30.0)	1.440 (36.6)	1.915 (48.6)
16/17	1.380 (35.0)	1.560 (39.6)	1.915 (48.6)
18/19	1.380 (35.0)	1.560 (39.6)	1.915 (48.6)
20/21	1.380 (35.0)	1.560 (39.6)	1.915 (48.6)
22/23	1.380 (35.0)	1.560 (39.6)	1.915 (48.6)
24/25	1.380 (35.0)	1.560 (39.6)	1.915 (48.6)
28/29	1.610 (40.9)	1.560 (39.6)	1.915 (48.6)
32/33	1.610 (40.9)	1.750 (44.5)	1.915 (48.6)
36	1.610 (40.9)	1.750 (44.5)	1.915 (48.6)
40	1.610 (40.9)	2.190 (55.6)	1.915 (48.6)

See inside back cover fold-out or pages 13 and 14 for unabridged Tables I and II.

**TABLE IV: ELBOW DIMENSIONS**

Elbow Size	E	F	G	H
	Max	Max	Max	Max
04	.567 (14.4)	1.187 (30.1)	.636 (16.2)	1.200 (30.5)
06	.630 (16.0)	1.250 (31.8)	.710 (18.0)	1.320 (33.5)
08	.692 (17.6)	1.312 (33.3)	.731 (18.6)	1.340 (34.0)
10	.755 (19.2)	1.655 (42.0)	.825 (21.0)	1.660 (42.2)
12	.848 (21.5)	1.765 (44.8)	.988 (25.1)	1.950 (49.5)
16	1.036 (26.3)	1.952 (49.6)	1.087 (27.6)	2.033 (51.6)
20	1.130 (28.7)	2.098 (53.3)	1.325 (33.7)	2.033 (51.6)
24	1.255 (31.9)	2.155 (54.7)	1.337 (34.0)	2.200 (55.9)
28	1.317 (33.5)	2.250 (57.2)	1.827 (46.4)	2.450 (62.2)
32	1.348 (34.2)	2.343 (59.5)	2.027 (51.5)	2.450 (62.2)

**TABLE X: CABLE ENTRY**

Dash No.	T Max	V Max	Cable Range	
			Min	Max
04	.780 (19.8)	.957 (24.3)	.125 (3.2)	.312 (7.9)
06	.780 (19.8)	1.145 (29.1)	.250 (6.4)	.437 (11.1)
08	.780 (19.8)	1.332 (33.8)	.312 (7.9)	.562 (14.3)
10	.780 (19.8)	1.332 (33.8)	.350 (8.9)	.625 (15.9)
12	.811 (20.6)	1.551 (39.4)	.500 (12.7)	.750 (19.1)
16	.905 (23.0)	1.770 (45.0)	.625 (15.9)	.937 (23.8)
20	1.092 (27.7)	2.113 (53.7)	.875 (22.2)	1.250 (31.8)
24	1.124 (28.5)	2.363 (60.0)	1.000 (25.4)	1.375 (34.9)
28	1.399 (35.5)	2.770 (70.4)	1.250 (31.8)	1.625 (41.3)
32	1.399 (35.5)	3.020 (76.7)	1.437 (36.5)	1.875 (47.6)

**TABLE XII: CABLE ENTRY**

Dash No.	Z Max	Cable Range	
		Min	Max
02	.968 (24.6)	.125 (3.2)	.250 (6.4)
03	1.046 (26.6)	.250 (6.4)	.375 (9.5)
04	1.156 (29.4)	.312 (7.9)	.500 (12.7)
05	1.218 (30.9)	.437 (11.1)	.625 (15.9)
06	1.343 (34.1)	.562 (14.3)	.750 (19.1)
07	1.468 (37.3)	.687 (17.4)	.875 (22.2)
08	1.593 (40.5)	.812 (20.6)	1.000 (25.4)
10	1.843 (46.8)	1.062 (27.0)	1.250 (31.8)

**TABLE XI: CABLE ENTRY**

Dash No.	W Max	X Max	Y Max	Cable Range	
				Min	Max
03*	.437 (11.1)	.760 (19.3)	.843 (21.4)	.156 (4.0)	.250 (6.4)
04*	.437 (11.1)	.760 (19.3)	.906 (23.0)	.188 (4.8)	.312 (7.9)
06*	.500 (12.7)	.760 (19.3)	1.093 (27.8)	.281 (7.1)	.438 (11.1)
08	.563 (14.3)	.760 (19.3)	1.187 (30.1)	.344 (8.7)	.562 (14.3)
10	.563 (14.3)	.760 (19.3)	1.281 (32.5)	.375 (9.5)	.625 (15.9)
12	.563 (14.3)	.760 (19.3)	1.500 (38.1)	.438 (11.1)	.750 (19.1)
16	.656 (16.7)	1.073 (27.3)	1.719 (43.7)	.562 (14.3)	.938 (23.8)
20	.656 (16.7)	1.323 (33.6)	2.062 (52.4)	.750 (19.1)	1.250 (31.8)
24	.656 (16.7)	1.323 (33.6)	2.312 (58.7)	.781 (19.8)	1.375 (34.9)
28	1.188 (30.2)	1.572 (39.9)	2.719 (69.1)	.969 (24.6)	1.625 (41.3)
32*	1.187 (30.1)	1.572 (39.9)	2.969 (75.4)	1.125 (28.6)	1.875 (47.6)
40*	1.125 (28.6)	1.572 (39.9)	3.531 (89.7)	1.469 (37.3)	2.375 (60.3)

\* Not available in Style M clamp.

**TABLE V: ELBOW**

Elbow Size	F <sup>1</sup>
	Max
04	1.550 (39.4)
06	1.610 (40.9)
08	1.670 (42.4)
10	1.760 (44.7)
12	1.870 (47.5)
16	2.060 (52.3)
20	2.210 (56.1)

Elbow Size	H <sup>1</sup>
	Max
04	1.560 (39.6)
06	1.680 (42.7)
08	1.700 (43.2)
10	1.770 (45.0)
12	1.860 (47.2)
16	2.030 (51.6)
20	2.140 (54.4)