

**CONNECTOR  
 DESIGNATORS  
 A-F-H-L-S  
 ROTATABL  
 COUPLING**

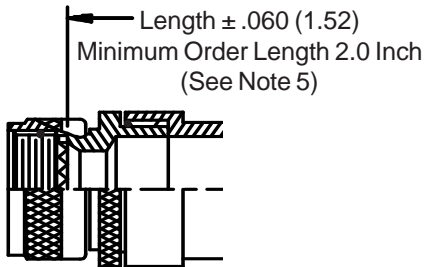

**STYLE 2**  
 (STRAIGHT  
 See Note 1)

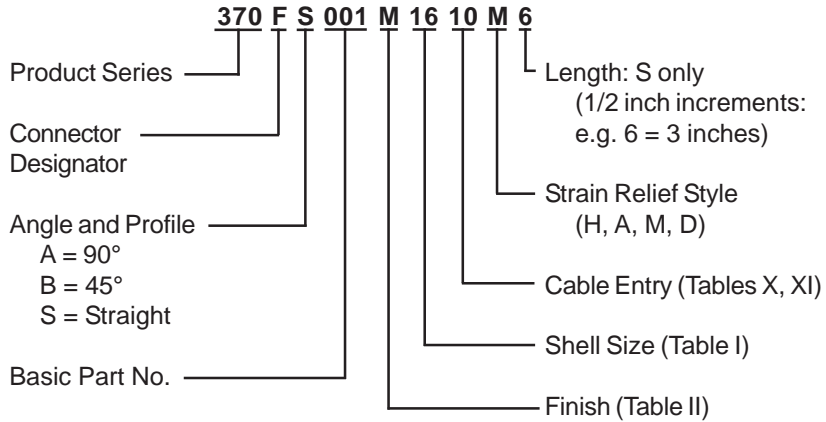
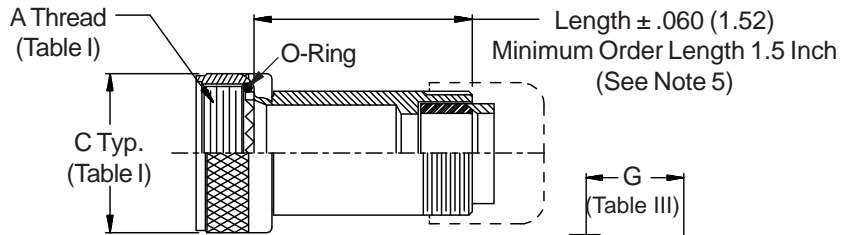

**STYLE 2**  
 (45° & 90°  
 See Note 1)

**-445** Now Available with the "NESTOR"  
 Glenair's Non-Detent, Spring-Loaded, Self-Locking Coupling.  
 Add "-445" to Specify This AS85049 Style "N" Coupling Interface.

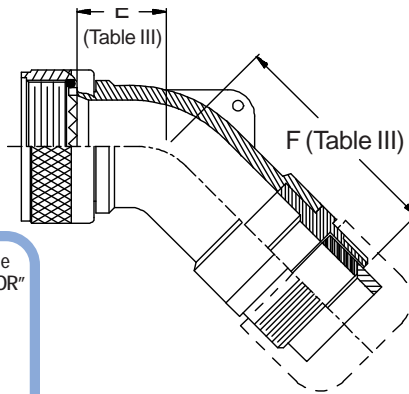

**STYLE H**  
 Heavy Duty  
 (Table X)

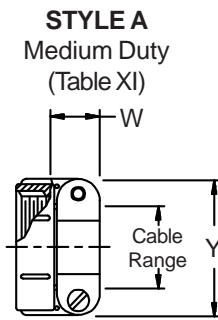

**STYLE A**  
 Medium Duty  
 (Table XI)

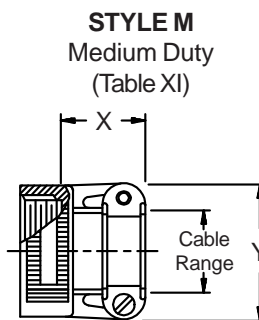

**STYLE M**  
 Medium Duty  
 (Table XI)

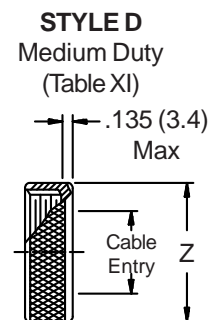

**STYLE D**  
 Medium Duty  
 (Table XI)

**370-001**  
**Submersible Cable Sealing Backshell**  
with Strain Relief  
**Low Profile - Rotatable Coupling**



**TABLE III: ELBOW DIMENSIONS**

Shell Size		E		F		G		H	
Conn. Desig.	H	Max		Max		Max		Max	
A-F-L-S									
08	09	.457	(11.6)	1.810	(46.0)	.500	(12.7)	1.820	(46.2)
10	11	.520	(13.2)	1.869	(47.5)	.595	(15.1)	1.940	(49.3)
12	13	.582	(14.8)	1.929	(49.0)	.610	(15.5)	1.960	(49.8)
14	15	.645	(16.4)	2.359	(59.9)	.700	(17.8)	2.369	(60.2)
16	17	.738	(18.7)	2.469	(62.7)	.885	(22.5)	2.459	(62.5)
18	19	.926	(23.5)	2.659	(67.5)	.975	(24.8)	2.629	(66.8)
20	21	.926	(23.5)	2.659	(67.5)	.975	(24.8)	2.629	(66.8)
22	23	1.020	(25.9)	2.872	(72.9)	1.125	(28.6)	2.802	(71.2)
24	25	1.020	(25.9)	2.872	(72.9)	1.125	(28.6)	2.802	(71.2)
28		1.145	(29.1)	2.905	(73.8)	1.225	(31.1)	2.955	(75.1)
32		1.207	(30.7)	3.005	(76.3)	1.575	(40.0)	3.205	(81.4)
36		1.238	(31.4)	3.315	(84.2)	1.775	(45.1)	3.255	(82.7)

1. When maximum cable entry (page 21) is exceeded, Style 2 will be supplied. Dimensions E, F, G and H will not apply. Please consult factory.
2. Metric dimensions (mm) are indicated in parentheses.
3. Cable range is defined as the accommodations range for the wire bundle or cable. Dimensions shown are not intended for inspection criteria.
4. Interface O-Ring not supplied with connector designator A.
5. Consult factory for shorter lengths on straight backshells.

**TABLE X: CABLE ENTRY**

Dash No.	T Max	V Max	Cable Range	
			Min	Max
04	.780 (19.8)	.957 (24.3)	.125 (3.2)	.312 (7.9)
06	.780 (19.8)	1.145 (29.1)	.250 (6.4)	.437 (11.1)
08	.780 (19.8)	1.332 (33.8)	.387 (9.8)	.562 (14.3)
10	.780 (19.8)	1.332 (33.8)	.350 (8.9)	.625 (15.9)
12	.811 (20.6)	1.551 (39.4)	.500 (12.7)	.750 (19.1)
16	.905 (23.0)	1.770 (45.0)	.625 (15.9)	.937 (23.8)
20	1.092 (27.7)	2.113 (53.7)	.875 (22.2)	1.250 (31.8)
24	1.124 (28.5)	2.363 (60.0)	1.000 (25.4)	1.375 (34.9)
28	1.399 (35.5)	2.770 (70.4)	1.250 (31.8)	1.625 (41.3)
32	1.399 (35.5)	3.020 (76.7)	1.437 (36.5)	1.875 (47.6)

See inside back cover fold-out or pages 13 and 14 for unbridged Tables I and II.

**TABLE II: STANDARD FINISHES**

GLENAIR	
SYMBOL	FINISH
B	Cadmium Plate, Olive Drab
C	Anodize, Black
G	Hard Coat, Anodic
M	Electroless Nickel
NF	Cadmium Plate, Olive Drab Over Electroless Nickel
See Inside Back Cover for Additional Finish Options	

**TABLE XI: CABLE ENTRY**

Dash No.	W Max	X Max	Y Max	Z Max	Cable Range	
					Min **	Max
03*	.437 (11.1)	.760 (19.3)	.843 (21.4)	.630 (16.0)	.156 (4.0)	.250 (6.4)
04*	.437 (11.1)	.760 (19.3)	.906 (23.0)	.755 (19.2)	.188 (4.8)	.312 (7.9)
06*	.500 (12.7)	.760 (19.3)	1.093 (27.8)	.942 (23.9)	.281 (7.1)	.438 (11.1)
08	.563 (14.3)	.760 (19.3)	1.187 (30.1)	1.067 (27.1)	.387 (9.8)	.562 (14.3)
10	.563 (14.3)	.760 (19.3)	1.281 (32.5)	1.192 (30.3)	.375 (9.5)	.625 (15.9)
12	.563 (14.3)	.760 (19.3)	1.500 (38.1)	1.380 (35.1)	.438 (11.1)	.750 (19.1)
16	.656 (16.7)	1.073 (27.3)	1.719 (43.7)	1.535 (39.0)	.625 (15.9)	.938 (23.8)
20	.656 (16.7)	1.323 (33.6)	2.062 (52.4)	1.848 (46.9)	.875 (22.2)	1.250 (31.8)
24	.656 (16.7)	1.323 (33.6)	2.312 (58.7)	2.255 (57.3)	1.000 (25.4)	1.375 (34.9)
28	1.188 (30.2)	1.572 (39.9)	2.719 (69.1)	2.505 (63.6)	1.250 (31.8)	1.625 (41.3)
32*	1.187 (30.1)	1.572 (39.9)	2.969 (75.4)	2.755 (70.0)	1.437 (36.5)	1.875 (47.6)
40*	1.125 (28.6)	1.572 (39.9)	3.531 (89.7)	3.255 (82.7)	1.875 (47.6)	2.375 (60.3)

\* Not available in Style M clamp.

\*\* Not Applicable Style D