

370-016 Composite Cable-Sealing Environmental Backshell with Self-Locking Rotatable Coupling and Strain-Relief Clamp or Nut

A

CONNECTOR DESIGNATOR:	
A	MIL-DTL-5015, -26482 Series II, and -83723 Series I and III
F	MIL-DTL-38999 Series I, II
L	MIL-DTL-38999 Series 1.5 (JN1003)
H	MIL-DTL-38999 Series III and IV
G	MIL-DTL-28840
U	DG123 and DG123A
SELF-LOCKING	
ROTATABLE COUPLING	
STANDARD PROFILE	

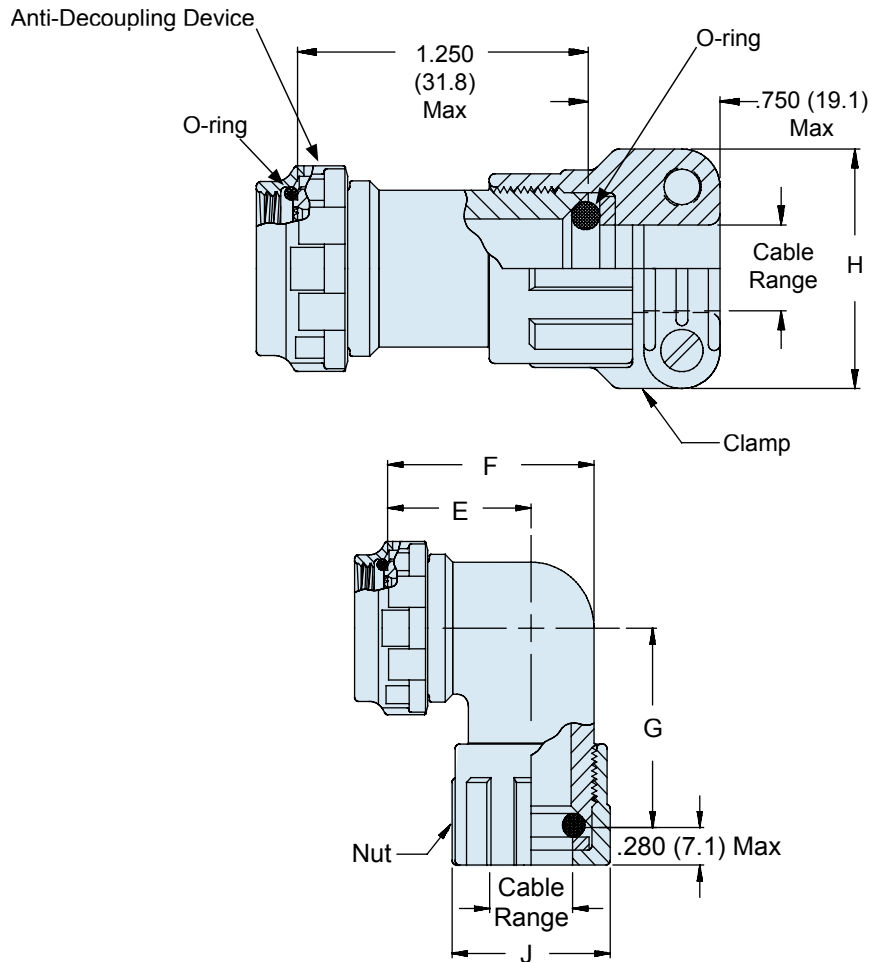
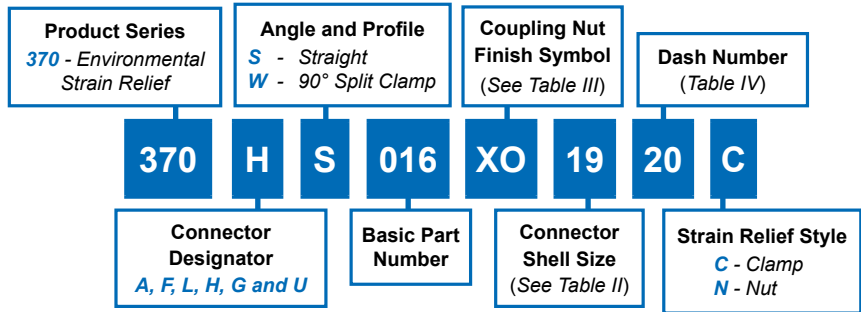

370-016

Composite Cable-Sealing Environmental Backshell with Self-Locking Rotatable Coupling and Strain-Relief Clamp or Nut



TABLE II: CONNECTOR SHELL SIZE ORDER NUMBER

Shell Size For Connector Designator*					E	F	G	Max Entry
A	F/L	H	G	U	±.06 (1.5)	±.09 (2.3)	±.09 (2.3)	Dash No.**
08	08	09	-	-	.69 (17.5)	.88 (22.4)	1.06 (26.9)	10
10	10	11	-	08	.75 (19.1)	1.00 (25.4)	1.13 (28.7)	12
12	12	13	11	10	.81 (20.6)	1.13 (28.7)	1.19 (30.2)	14
14	14	15	13	12	.88 (22.4)	1.31 (33.3)	1.25 (31.8)	16
16	16	17	15	14	.94 (23.9)	1.38 (35.1)	1.31 (33.3)	20
18	18	19	17	16	.97 (24.6)	1.44 (36.6)	1.34 (34.0)	20
20	20	21	19	18	1.06 (26.9)	1.63 (41.4)	1.44 (36.6)	22
22	22	23	-	20	1.13 (28.7)	1.75 (44.5)	1.50 (38.1)	24
24	24	25	23	22	1.19 (30.2)	1.88 (47.8)	1.56 (39.6)	28
28	-	-	25	24	1.34 (34.0)	2.13 (54.1)	1.66 (42.2)	32

**Consult factory for additional entry sizes available.

TABLE IV: CABLE ENTRY

Dash No.	Clamp		H		J		Cable Range *	
	Saddle	Closed	±.06 (1.5)	±.06 (1.5)	Minimum	Maximum		
10	.20	(5.1)	.94 (23.9)	.80 (20.3)	.13 (3.3)	.25 (6.4)		
12	.29	(5.1)	1.17 (29.7)	.93 (23.6)	.25 (6.4)	.38 (9.7)		
14	.40	(10.2)	1.28 (32.5)	1.06 (26.9)	.31 (7.9)	.44 (11.2)		
16	.48	(12.2)	1.41 (35.8)	1.22 (31.0)	.50 (12.7)	.63 (15.9)		
18	.55	(14.0)	1.50 (38.1)	1.24 (31.5)	.56 (14.2)	.69 (17.5)		
20	.64	(16.0)	1.56 (39.6)	1.37 (34.8)	.63 (16.0)	.75 (19.1)		
22	.72	(18.3)	1.69 (42.9)	1.49 (37.8)	.75 (19.1)	.88 (22.2)		
24	.79	(20.1)	1.81 (46.0)	1.62 (41.1)	.88 (22.4)	1.00 (25.4)		
28	.89	(22.0)	1.91 (48.5)	1.68 (42.7)	1.00 (25.4)	1.13 (28.6)		
32	.96	(24.0)	2.02 (51.3)	1.82 (46.2)	1.13 (28.6)	1.25 (31.8)		

* Cable range equals diameter of cable outer jacket.

NOTES

1. Coupling nut supplied unplated.
2. See Table I in Intro for front-end dimensional details.

TABLE III: FINISH

Symbol	Finish Description
XB	No Plating - Black Color (Non-Conductive Finish)
XM	2000 Hour Corrosion Resistant Electroless Nickel
XMT	2000 Hour Corrosion Resistant Ni-PTFE, Nickel-Fluorocarbon Polymer. <i>1000 Hour Grey™</i>
XO	No Plating - Brown Color (Non-Conductive Finish)
XW	2000 Hour Corrosion Resistant Cadmium/Olive Drab over Electroless Nickel